

2025/26

FOOD PROCESSING EQUIPMENT

Attrezzature professionali per la ristorazione



Guida alla Lettura

READING GUIDE
GUIDE DE LECTURE
LESEHILFE
GUÍA DE LECTURA
РУКОВОДСТВО ПО ЧТЕНИЮ

IT

Fimar è un brand completamente Made in Italy dedicato alla produzione di macchinari per la lavorazione della carne, della pasta, della pelatura, taglio e conservazione degli alimenti, cottura, snack bar ed infine una sezione destinata al lavaggio.

Fimar S.P.A. dal 1979, è un'azienda italiana specializzata in progettazione, produzione e vendita di macchinari per la ristorazione professionale.

Fimar conta oltre 100.000 macchine vendute in un anno, più di 5.000 distributori mondiali in 100 Paesi nel mondo, una superficie di copertura totale di 38.000 metri quadrati ubicati a Villa Verucchio.

Offriamo un servizio clienti e assistenza di altissima qualità grazie ad un personale multilingua preparato ed efficiente.

EN

Fimar is a completely Made in Italy brand dedicated to the production of equipment for the processing of meat, pasta, peeling, cutting and preservation of food, cooking, snack bars and finally a section dedicated to dishwashing.

Fimar S.P.A. since 1979, is an Italian company dedicated to the design, production and sale of professional catering machinery.

Fimar numbers over 100,000 machines sold in one year, more than 5,000 distributors worldwide in 100 different countries, a production area of 38,000 square meters located in Villa Verucchio.

We provide the highest quality of customer service and assistance thanks to our skilled and highly efficient multilingual staff.

FR

Fimar est une marque entièrement Made in Italy qui se consacre à la production d'équipements pour le traitement de la viande, des pâtes, l'épluchage, la découpe et la conservation des aliments, la cuisine, les snacks et enfin une section dédiée au lavage.

Fimar S.P.A. depuis 1979, est une entreprise italienne dédiée à la conception, à la production et à la vente de machines pour la restauration professionnelle.

Fimar compte plus de 100.000 machines vendues en un an, plus de 5.000 distributeurs dans 100 pays différents, une surface de production de 38.000 mètres carrés située à Villa Verucchio.

Nous offrons un service à la clientèle et une assistance de la plus haute qualité grâce à notre personnel multilingue compétent et hautement efficace.



Cerca il bollino novità e scopri le tutte!

Look for the new sticker and discover them all!

Cherchez la vignette de la nouveauté et découvrez-les tous!

Achten sie auf den neuheitsaufkleber und entdecken sie sie alle!

¡Busque la etiqueta de novedad y descúbralos todos!

Найдите наклейку с новинкой и откройте для себя их все!



DE

Fimar ist eine vollständig „Made in Italy“-Marke, die sich der Herstellung von Geräten für die Verarbeitung von Fleisch und Teigwaren, für das Schälen, Schneiden und Konservieren von Lebensmitteln, für das Kochen, für Snackbars und schließlich auch für das Geschirrspülen widmet.

Fimar S.P.A. ist ein italienisches Unternehmen, das sich seit 1979 auf die Entwicklung, Produktion und den Verkauf von professionellen Gastronomiemaschinen spezialisiert hat.

Fimar zählt über 100.000 verkaufte Maschinen in einem Jahr, mehr als 5.000 Händler weltweit in 100 verschiedenen Ländern, eine Produktionsfläche von 38.000 Quadratmetern in Villa Verucchio.

Dank unserer qualifizierten und hocheffizienten mehrsprachigen Mitarbeiter bieten wir höchste Qualität bei Kundenservice und -betreuung.

ES

Fimar es una marca completamente Made in Italy dedicada a la producción de equipos para la elaboración de carne, pasta, pelado, corte y conservación de alimentos, cocción, snacks y, por último, una sección dedicada al lavado de vajilla.

Fimar S.P.A. desde 1979, es una empresa italiana que se dedica a diseñar, fabricar y vender máquinas profesionales para el catering.

Fimar cuenta con más de 100.000 máquinas vendidas en un año, más de 5.000 distribuidores en todo el mundo en 100 países diferentes, un área de producción de 38.000 metros cuadrados ubicada en Villa Verucchio.

Gracias a nuestro personal multilingüe altamente cualificado y eficiente, ofrecemos la mejor calidad de servicio y asistencia al cliente.

RU

Fimar - это полностью итальянский бренд, занимающийся производством оборудования для обработки мяса, пасты, очистки, нарезки и консервации продуктов, приготовления пищи, закусок и, наконец, раздела, посвященного мытью посуды.

















Fimar S.P.A. - это итальянская компания, специализирующаяся с 1979 года на разработке, производстве и продаже профессионального оборудования для общественного питания.





Fimar продает более 100 000 машин в год, более 5 000 дилеров по всему миру в 100 различных странах, производственная площадь 38 000 квадратных метров в районе Villa Verucchio.

















Благодаря высококвалифицированному и высокоэффективному многоязычному персоналу мы предлагаем высочайшее качество обслуживания и поддержки клиентов.





















Icone

ICONS
ICÔNES
SYMBÔLE
ICONOS
ИКОНКИ

	IT	EN	FR	DE	ES	RU
	INFORMAZIONI	INFORMATION	INFORMATION	INFO	INFORMACIÓN	ИНФОРМАЦИЯ
	POTENZA	POWER	PUISSANCE	LEISTUNG	POTENCIA	МОЩНОСТЬ
	POTENZA GAS	GAS POWER	PUISSANCE GAZ	GASLEISTUNG	ENERGÍA DE GAS	ГАЗОВАЯ ЭНЕРГИЯ
 3 Ph	ALIMENTAZIONE TRIFASE	THREE-PHASE POWER SUPPLY	ALIMENTATION TRIPHASÉE	DREIPHASIGE STROMVERSORGUNG	ALIMENTACIÓN TRIFÁSICA	ТРЕХФАЗНЫЙ ИСТОЧНИК ПИТАНИЯ
 1 Ph	ALIMENTAZIONE MONOFASE	SINGLE-PHASE POWER SUPPLY	ALIMENTATION MONOPHASÉE	EINPHASIGE STROMVERSORGUNG	ALIMENTACIÓN MONOFÁSICA	ОДНОФАЗНЫЙ ИСТОЧНИК ПИТАНИЯ
	DIMENSIONI MACCHINA	MACHINE DIMENSIONS	DIMENSIONS DES MACHINES	MASCHINE NABMESSUNGEN	MEDIDAS MÁQUINA	РАЗМЕРЫ СТАНКА
	INFO SPEDIZIONI	DELIVERY INFO	INFORMATIONS SUR LA LIVRAISON	VERSANDINFO	INFORMACIÓN SOBRE ENVÍO	ИНФОРМАЦИЯ ИНФОРМАЦИЯ ШИППИНГА
 Kg	PESO NETTO	NET WEIGHT	POIDS NET	NETTOGEWICHT	PESO NETO	ВЕС НЕТТО
 Kg	PESO LORDO	GROSS WEIGHT	POIDS BRUT	BRUTTOGEWICHT	PESO BRUTO	ВЕС БРУТТО
 mm	DIMENSIONI DI IMBALLO	PACKAGING DIMENSIONS	DIMENSIONS DES EMBALLAGES	VERPACKUNGSMASSE	MEDIDAS DEL EMBALAJE	РАЗМЕРЫ УПАКОВКИ
 m³	VOLUME DI IMBALLO	PACKAGING VOLUME	VOLUME D'EMBALLAGE	VERPACKUNGSSUMFANG	VOLUMEN DEL EMBALAJE	ОБЪЕМ УПАКОВКИ
	PREZZO	PRICE	PRIX	PREIS	PRECIO	ПРИСЕ
	CE	CE	CE	CE	CE	CE
	NO CE	NO CE	NO CE	KEIN CE	NO CE	НЕТ CE
 RPM	VELOCITÀ	SPEED	VITESSE	GESCHWINDIGKEIT	VELOCIDAD	БЫСТРОТА
	CAPACITÀ NOMINALE	NOMINAL CAPACITY	CAPACITÉ NOMINALE	NENNKAPAZITÄT	CAPACIDAD NOMINAL	НОМИНАЛЬНАЯ МОЩНОСТЬ
 Kg/h	PRODUZIONE ORARIA	HOURLY PRODUCTION	PRODUCTION HORAIRE	STUNDENPRODUKTION	PRODUCCIÓN HORARIA	ПОЧАСОВОЕ ПРОИЗВОДСТВО

	IT	EN	FR	DE	ES	RU
	DIMENSIONI DEL PIANO DI LAVORO	DIMENSIONS OF THE WORKTOP	DIMENSIONS DU PLAN DE TRAVAIL	ABMESSUNGEN DER ARBEITSPLATTE	MEDIDAS DEL PLAN DE TRABAJO	РАЗМЕРЫ СТОЛЕШНИЦЫ
	DIMENSIONI INTERNE DELLA MACCHINA	INTERNAL DIMENSIONS OF THE MACHINE	DIMENSION INTÉRIEURE DE LA MACHINE	INNENMASS DER MASCHINE	MEDIDA INTERIOR DE LA CUCHILLA	ВНУТРЕННИЙ РАЗМЕР МАШИНЫ
	TIPO DI GAS	TYPE OF GAS	TYPE DE GAZ	GASTYP	TIPO DE GAS	ВИД ГАЗА
	NUMERO DI BRUCIATORI	NUMBER OF BURNERS	NOMBRE DE BRÛLEURS	ANZAHL DER BRENNER	NÚMERO DE QUEMADORES	КОЛИЧЕСТВО ГОРЕЛОК
	NUMERO DI PIEZOELETRICI	NUMBER OF PIEZOELECTRICS	NOMBRE DE PIÉZOÉLECTRIQUES	ANZAHL DER PIEZOELEMENTE	NÚMERO DE PIEZOELÉCTRICOS	КОЛИЧЕСТВО ПЬЕЗОЭЛЕКТРИКОВ
	TRITACARNE	MEAT MINCER	HACHOIR À VIANDE	SFLEISCHWOLF	PICADORA DE CARNE	ИЗМЕЛЬЧЕНИЯ МЯСА
	GRATTUGIA	GRATER	RÂPE	REIBE	RALLADOR	ТЕРКИ
	SVILUPPO LAMA	BLADE EXTENSION	EXTENSION DE LAME	KLINGENLÄNGE	LARGO DE LA CUCHILLA	ДЛИНА НОЖА
	TAGLIO UTILE	CUTTING WIDTH	LARGEUR DE COUPE	SCHNITTWEITE	ANCHO DE CORTE	ШИРИНА РЕЗА
	LAMA SEGAOSSA	BONE SAW BLADE	LAME DE SCIE À OS	KNOCHENSÄGE-KLINGE	CUCHILLA SIERRA PARA HUESOS	НОЖА ПОЛЕЗНАЯ КОСТНАЯ ПИЛА
	NUMERO DI PALE	NUMBER OF BLADES	NOMBRE DE PELLÉS	ANZAHL DER SCHAUFELN	NÚMERO DE PALAS	КОЛИЧЕСТВО ЛОПАТ
	IMBUTO	FUNNEL	ETONNOIR	TRICHTER	EMBUDO	НАСАДКИ
	CAPACITÀ DELLA VASCA	CAPACITY OF THE BOWL	CAPACITÉ DU CONTENANT	BEHÄLTERKAPAZITÄT	CAPACIDAD RECIPIENTE	ВМЕСТИМОСТЬ СМЕСИТЕЛЬНОГО БАКА
	IMPASTO PER CICLO	DOUGH FOR CYCLE	PÂTE PAR CYCLE	TEIG PRO ZYKLUS	MASA PARA CICLO	КОЛ-ВО ТЕСТА ЗА ЦИКЛ
	TIMER	TIMER	MINUTERIE	SCHALTUHR	TEMPORIZADOR	ТАЙМЕР
	TRAFILE	MOULDS	FILIÈRES	EINSÄTZE	MOLDES	ВСТАВОК
	LUNGHEZZA RULLI	ROLLER LENGTH	LONGUEUR DU ROULEAU	ROLLENLÄNGE	LONGITUD RODILLOS	РОЛЛЕР ЛЕНГТЬ
	APERTURA RULLI	ROLLER OPENING	OUVERTURE DU ROULEAU	ROLLEN-ÖFFNUNG	APERTURA RODILLOS	РОЛЛЕР ОТКРЫТИЕ
	MESCOLATORE	BLENDER	MÉLANGEUR	RÜHRER	MEZCLADOR	СМЕСИТЕЛЯ

	IT	EN	FR	DE	ES	RU
	FRUSTA	WHISK	FOUET	SCHNEEBESEN	BATIDOR	ВЕНЧИКА
	BLOCCO MOTORE	MOTOR UNIT	GROUPE MOTEUR	MOTOREINHEIT	BLOQUE MOTOR	МОТОРНЫМ БЛОКОМ
 RPM	BLOCCO MOTORE CON VARIATORE	MOTOR UNIT WITH SPEED REGULATOR	GROUPE MOTEUR AVEC MOTORÉDUCTEUR	MOTOREINHEIT MIT DREHZAHLEGLER	BLOQUE MOTOR CON VARIADOR	МОТОРНЫМ БЛОКОМ С ВАРИАТОРОМ СКОРОСТИ
 RPM	BLOCCO MOTORE CON VARIATORE E FRUSTA	MOTOR UNIT WITH SPEED REGULATOR AND WHISK	GROUPE MOTEUR AVEC MOTORÉDUCTEUR ET FOUET	MOTOREINHEIT MIT DREHZAHLEGLER UND SCHNEEBESEN	BLOQUE MOTOR CON VARIADOR Y BATIDOR	МОТОРНЫМ БЛОКОМ С ВАРИАТОРОМ СКОРОСТ И ВЕНЧИК
 RPM	BLOCCO MOTORE CON VARIATORE E MESCOLATORE	MOTOR UNIT WITH SPEED REGULATOR AND BLENDER	GROUPE MOTEUR AVEC MOTORÉDUCTEUR ET MÉLANGEUR	MOTOREINHEIT MIT DREH- ZAHLEGLER UND RÜHRER	BLOQUE MOTOR CON VARIADOR Y MEZCLADOR	МОТОРНЫМ БЛОКОМ С ВАРИАТОРОМ СКОРОСТ И СМЕСИТЕЛЯ
	LIVELLO MASSIMO DI IMMERSIONE	IMMERSION LIMIT	NIVEAU MAXIMAL D'IMMERSION	MAXIMALE EINTAUCHTIEFE	MÁXIMO NIVEL DE INMERSIÓN	МАКС. УРОВЕНЬ ПОГРУЖЕНИЯ ВЕНЧИКА
	DIMENSIONE DELLA LAMA	BLADE SIZE	TAILLE DE LA LAME	KLINGENGRÖSSE	MEDIDA DE LA CUCHILLA	НОЖА
	TAGLIO UTILE	USEFUL CUT	COUPE UTILE	NÜTZLICHER SCHNITT	ÚTIL DE CORTE	ПОЛЕЗНАЯ ДЛИНА РЕЗКИ
	BARRA SALDANTE/ HOT-WELD SEALER	SEALING BAR	BARRE DE SOUDURE	SCHWEISSSTAB	BARRA TERMOSELLADO	СВАРОЧНАЯ ПЛАНКА
	POMPA VUOTO/ VACUUM PUMP	VACUUM PUMP	POMPE A VIDER	VAKUUM PUMPE	BOMBA VACÍO	ВАКУУМНЫЙ НАСОС
	VUOTO MAX OTTENIBILE/ MAX ACHIEVABLE VACUUM	MAX OBTAINABLE VACUUM	VIDE MAX POSSIBLE	MAX MÖGLICHES VAKUUM	MÁXIMO VACÍO OBTENIBLE	МАКСИМАЛЬНО ДОСТИЖИМЫЙ ВАКУУМ
	PRODUZIONE ORARIA NUMERO PEZZI	HOURLY PRODUCTION NUMBER OF PIECES	PRODUCTION HORAIRE NOMBRE DE PIÈCES	STÜNDLICHE PRODUKTION TEILEANZAHL	PRODUCCIÓN HORARIA NÚMERO DE PIEZAS	ПОЧАСОВОЕ ПРОИЗВОДСТВО КОЛИЧЕСТВО ШТУК
	TEMPERATURA DI LAVORO	WORKING TEMPERATURE	TEMPÉRATURE DE FONCTIONNEMENT	BETRIEBSTEMPERATUR	TEMPERATURA DE TRABAJO	РАБОЧАЯ ТЕМПЕРАТУРА
	CAPACITÀ/DIMENSIONI DELLA CAMERA DI COTTURA	CAPACITY / DIMENSIONS OF THE COOKING CHAMBER	CAPACITÉ/DIMENSIONS DE LA CHAMBRE DE CUISSON	KAPAZITÄT / ABMESSUNGEN DES GARRAUMS	CAPACIDAD / DIMENSIONES DE LA CÁMARA DE COCCIÓN	ВМЕСТИМОСТЬ / ГАБАРИТЫ ВАРОЧНОЙ КАМЕРЫ
	kcal/h BTU/h	CALORIE	CALORIES	KALORIEN	CALORÍAS	КАЛОРИИ
	METANO METHANE METAHA	CONSUMO METANO	CONSUMATION DE MÉTHANE	METHANVERBRAUCH	CONSUMO METANO	ПОТРЕБЛЕНИЕ МЕТАНА
	GPL LPG	CONSUMO GPL	CONSUMATION DE LPG	LPG-VERBRAUCH	CONSUMO GPL	ПОТРЕБЛЕНИЕ LPG

	IT	EN	FR	DE	ES	RU
	RAGGIUNGIMENTO DELLA TEMPERATURA	TEMPERATURE ACHIEVEMENT	TEMPÉRATURE ATTEINTE	EINGESTELLTE TEMP. ERREICHT	ALCANCE TEMPERATURA	ДОСТИЖЕНИЕ ТЕМПЕРАТУРЫ
	NUMERO DI TEGLIE	NUMBER OF TRAYS	NOMBRE DE PLAQUES	ANZAHL DER BLECHE	NÚMERO BANDEJAS	КОЛИЧЕСТВО ЛОТКОВ
	CAPACITÀ OLIO	OIL CAPACITY	CAPACITÉ D'HUILE	ÖLKAAPAZITÄT	CAPACIDAD ACEITE	МАСЛО КАПАБИЛЬНОСТЬ
	CAPACITÀ DEL CESTO	CAPACITY OF THE BASKET	CAPACITÉ DUPANIER	KORBKAAPAZITÄT	CAPACIDAD CESTA	ВМЕСТИМОСТЬ КОРЗИНЫ
	DIMENSIONI DEL PIANO DI COTTURA	DIMENSIONS OF THE COOKING SURFACE	DIMENSIONS DE LA TABLE DE CUISSON	ABMESSUNGEN DER KOCHPLATTE	MEDIDAS DE LA PLACA DE COCCIÓN	РАЗМЕРЫ ВАРОЧНОЙ ПАНЕЛИ
	ALTEZZA UTILE PER LA COTTURA	USEFUL COOKING HEIGHT	HAUTEUR UTILE POUR LA CUISSON	NUTZHÖHE ZUM KOCHEN	ALTURA ÚTIL PARA LA COCCIÓN	ПОЛЕЗНАЯ ВЫСОТА ДЛЯ ПРИГОТОВЛЕНИЯ ПИЩИ
	CAPACITÀ CARNE	MEAT CAPACITY	CAPACITÉ DE VIANDE	FLEISCHKAPAZITÄT	CAPACIDAD CARNE	ПОТЕНЦИАЛЬНЫЙ МЯС ПОТЕНЦИАЛЬНЫЙ
	RESISTENZE	HEATING ELEMENTS	RESISTANCES	HEITZSTÄBE	RESISTENCIAS	РЕЗИСТАНЦИИ
	CAPACITÀ DEL BICCHIERE	GLASS CAPACITY	CAPACITÉ DU VERRE	BECHERKAAPAZITÄT	CAPACIDAD VASO	ЁМКОСТЬ СТЕКЛА
	SUPERFICIE DELLA PIASTRA	PLATE SURFACE	SURFACE DE LA PLAQUE	OBERFLÄCHE DER PLATTE	SUPERFICIE DE LA PLACE	ПОВЕРХНОСТЬ ПЛИТЫ
	DIMENSIONE RULLI	ROLLER DIMENSIONS	LONGUEUR DES ROULEAUX	ROLLENLÄNGE	LARGO RODILLOS ДЛИНА ВАЛКОВ	DIMENSIONE RULLI
	DIMENSIONE BOBINA	COIL DIMENSION	TAILLE DE BOBINE	SPÜLENGRÖÖE	TAMAÑO DE BOBINA	РАЗМЕР КАТУШКИ
	POMPA LAVAGGIO	WASHING PUMP	POMPE DE LAVAGE	WASCHPUMPE	BOMBA DE LAVADO	МОЕЧНЫЙ НАСОС
	CONSUMO ACQUA PER CICLO	WATER CONSUMPTION PER CYCLE	CONSOMMATION D'EAU PAR CYCLE	WASSERVERBRAUCH PRO ZYKLUS	CONSUMO DE AGUA POR CICLO	РАСХОД ВОДЫ НА ЦИКЛ
	RESISTENZA BOILER	BOILER HEATING ELEMENT	RÉSISTANCE CHAUDIÈRE	KESSELHEIZSTAB	RESISTENCIA DE LA CALDER	НАГРЕВАТЕЛЬНЫЙ ЭЛЕМЕНТ КОТЛА
	CAPACITÀ BOILER	BOILER CAPACITY	CAPACITÉ CHAUDIÈRE	KESSELHEIZSTAB	CAPACIDAD DE LA CALDERA	МОЩНОСТЬ КОТЛА
	RESISTENZA VASCA	TANK HEATING ELEMENT	RÉSISTANCE DU RÉSERVOIR	KESSELKAAPAZITÄT	RESISTENCIA DEL TANQUE	НАГРЕВАТЕЛЬНЫЙ ЭЛЕМЕНТ БАКА
	BRACCI DI LAVAGGIO E RISCIAQUO	WASH AND RINS ARMS	BRAS DE LAVAGE ET RINÇAGE	WASCH- UNS SPÜLARME	BRAZOS DE LAVADO Y ACLARADO	РУКОЯТКИ ДЛЯ МЫТЬЯ И ОМОЛАСКИВАНИЯ
	ALTEZZA MACCHINA BICCHIERI	MAX. GLASS HEIGHT	MAX. HAUTEUR VERRE	MAX. GLASHÖHE	MAX. ALTURA DEL VIDRIO	МАКС. ВЫСОТА СТАКАНОВ
	DIAMETRO MAX. PIATTI	MAX. PLATES DIAMETER	DIAMÈTRE MAX. ASSIETTE	MAX. TELLERDURCHMESSER	MAX. DIÁMETRO DE LAS PLACAS	МАКС. ДИАМЕТР ТАРЕЛКИ
	CONSUMO ACQUA PER CICLO	WATER QUANTITY PER CYCLE	QUANTITÉ D'EAU PAR CYCLE	WASSERVERBRAUCH JE ZYKLUS	CONSUMO DE AGUA POR CICLO	РАСХОД ВОДЫ НА ЦИКЛ



20



LAVORAZIONE CARNE
MEAT PROCESSING
PREPARATION DE LA VIANDE FLEISCHVERARBEITUNG
ELABORACIÓN CARNE
ОБРАБОТКА МЯСА

82



LAVORAZIONE PASTA
PASTA PROCESSING
TRAVAIL DE LA PATE TEIGVERARBEITUNG
ELABORACIÓN PASTA
ОБРАБОТКА ТЕСТА

176



TAGLIO, PELATURA E CONSERVAZIONE
CUTTING PEELING AND CONSERVATION
COUPE PELAGE ET CONSERVATION
SCHNEIDEN, SCHÄLEN UND LAGERN
CORTAR, PELAR Y CONSERVAR
РЕЗКА, ОТСЛАИВАНИЕ И ХРАНЕНИЕ

266



COTTURA
COOKING
CUISSON GAREN
COCCIÓN
ПРИГОТОВЛЕНИЕ

376



SNACK BAR
ЗАКУСОЧНАЯ

410



LAVAGGIO
WASH
LAVER
WASCHEN
СТИРАТЬ

Indice

INDEX
TABLE DES MATIÈRES
INHALTSVERZEICHNIS
INDEX
СОДЕРЖАНИЕ

IT	EN	FR	DE	ES	RU	
CONDIZIONI GENERALI DI VENDITA	GENERAL SALES CONDITIONS	CONDITIONS GÉNÉRALES DE VENTE	ALLGEMEINE VERKAUFSBEDINGUNGEN	CONDICIONES GENERALES DE VENTA	ОБЩИЕ УСЛОВИЯ ПРОДАЖИ	18
TRITACARNE	MEAT MINCER	HACHOIR À VIANDE	FLEISHWOLF	PICADORA DE CARNE	МЯСОРУБКА	22
ABBINATO TRITACARNE GRATTUGIA	COMBINED MEAT MINCER AND GRATER	COMBINE HACHOIR A VIANDE ET RÂPE FROMAGE	GEKOPPELTE FLEISCHWOLF UND KÄSEREIBE	EQUIPO COMBINADO PICADORA DE CARNE Y RALLADOR	КОМБИНИРОВАННАЯ МЯСОРУБКА-ТЕРКА	62
GRATTUGIA	GRATER	RÂPE	KÄSEREIBE	RALLADOR	ТЕРКА	64
ABBINATO TRITACARNE GRATTUGIA AB8D - TR8D - GR8D	COMBINED MEAT MINCER AND GRATER AB8D - TR8D - GR8D	COMBINE HACHOIR A VIANDE ET RÂPE FROMAGE AB8D - TR8D - GR8D	GEKOPPELTE FLEISCHWOLF UND KÄSEREIBE AB8D - TR8D - GR8D	EQUIPO COMBINADO PICADORA DE CARNE Y RALLADOR AB8D - TR8D - GR8D	КОМБИНИРОВАННАЯ МЯСОРУБКА-ТЕРКА AB8D - TR8D - GR8D	66
SEGAOSSI A NASTRO	BONE BANDSAW	SCIÉ À OS	KNOCHENBANDSÄGE	SIERRAS PARA HUESOS CON CINTA	ЛЕНТОЧНЫЕ ПИЛЫ ДЛЯ АСПИЛА КОСТЕЙ	72
IMPASTATRICI PER CARNE	MEAT MIXER	MÉLANGEUR À VIANDE	FLEISCH MISCHMASCHINEN	AMASADORAS PARA CARNE	ФАРШЕМЕШАЛКИ	75
INSACCATRICI MANUALI	MANUAL SAUSAGE FILLERS	POUSOIRS À SAUCISSES MANUELS	MANUELLE WURSTFÜLLMASCHINEN	EMBUTIDORAS MANUALES	РУЧНЫЕ НАПОЛНИТЕЛИ КОЛБАС	78
PRESSAMBURGER	MANUAL HAMBURGER PRESS	PRESSE-HAMBURGER MANUELLE	MANUELLE HAMBURGERPRESSE	FORMADORA DE HAMBURGUESAS MANUAL	РУЧНОЙ ПРЕСС ДЛЯ ГАМБУРГЕРОВ	80
MACCHINA PASTA FRESCA	PASTA MACHINE	MACHINE À PÂTE	NUDELMASCHINE	MÁQUINA PARA PASTA FRESCA	МАШИНКА ДЛЯ ПРИГОТОВЛЕНИЯ СВЕЖИХ МАКАРОННЫХ ИЗДЕЛИЙ	84
IMPASTATRICE A SPIRALE	SPIRAL KNEADER	PETRIN A SPIRAL	SPIRALTEIGKNETMASCHINE	AMASADORA DE ESPIRAL	СПИРАЛЬНЫЙ ТЕСТОМЕС	98
IMPASTATRICE BERTA	"BERTA" KNEADER	"BERTA" PETRIN	"BERTA" TEIGKNETMASCHINE	"BERTA" AMASADORA	"BERTA" ТЕСТОМЕС	150
IMPASTATRICE A FORCELLA	FORK KNEADER	PETRISSEUSE À FOURCHE	GABELKNETER	AMASADORA DE HORQUILLA	ВИЛОЧНЫЙ ТЕСТОМЕС	154
ARROTONDATRICE	DOUGH ROUNDER	ARRONDISSEUR DE PÂTE	TEIGABRUNDER	BOLEADORA	ТЕСТООКРУГЛИТЕЛИ	158
STENDIPIZZA	PIZZA ROLLER MACHINE	FAÇONNEUSE POUR PIZZA	PIZZATEIGAUSROLL MASCHINE	MÁQUINA PARA EXTENDER MASA DE PIZZA CON RODILLOS	ТЕСТОРАСКАТОЧНАЯ МАШИНА ДЛЯ ПИЦЦЫ	160
SFOGLIATRICI STENDIPIZZA	PASTA AND PIZZA ROLLER MACHINE	FAÇONNEUSE POUR PÂTE ET PIZZA	PIZZA- UND TEIGAUSROLLMASCHINE	MÁQUINA PARA EXTENDER MASA DE PIZZA CON RODILLOS	ТЕСТОРАСКАТОЧНАЯ МАШИНА ДЛЯ ПИЦЦЫ	164
IMPASTATRICE PLANETARIA	PLANETARY MIXER	MÉLANGEUR PLANÉTAIRE	PLANETENMISCHER	AMASADORA PLANETARIA	ПЛАНЕТАРНЫЙ ТЕСТОМЕС	166
MIXER AD IMMERSIONE	IMMERSION BLENDER	MIXEUR À IMMERSION	EINTAUCH-MIXSTAB	TRITURADORA A INMERSIÓN	ПОГРУЖНОЙ БЛЕНДЕР	178
TAGLIAVERDURA	VEGETABLE CUTTER	COUPE-LÉGUMES	GEMÜSESCHNEIDER	CORTADORAS DE HORTALIZAS	ОВОЩЕРЕЗКА	186
TAGLIAMOZZARELLA	MOZZARELLA CUTTER	COUPE-MOZZARELLA	MOZZARELLASCHNEIDER	CORTADORAS DE MOZZARELLA	КУСАЧЕК МОЦАРЕЛЛЫ	196
CUTTER	CUTTER	CUTTER	CUTTER	CUTTER	CUTTER	200
PELAPATATE	POTATO PEELER	ÉPLUCHEUSE À POMMES DE TERRE	KARTOFFELSCHÄLER	PELAPAPAS	КАРТОФЕЛЕЧИСТКА	208
LAVACOZZE	MUSSEL WASHER	LAVE-MOULES	MUSCHELNWASCHMASCHINE	LAVADORAS DE MEJILLONES	МАШИНА ДЛЯ ОЧИСТКИ МИДИЙ	216

IT	EN	FR	DE	ES	RU	
LAVAVERDURE CENTRIFUGA	VEGETABLE WASHER AND DRYER	LAVEUSES À LÉGUMES ET ESSOREUSES	GEMÜSEWASCH-UND TROCKNERMASCHINE	LAVADORA DE VERDURAS Y CENTRIFUGADORA	ПРИБОР ДЛЯ МОЙКИ ОВОЩЕЙ И СУШКИ ЛИСТЬЕВ САЛАТА	224
AFFETTATRICI A VOLANO	FLYWHEEL MANUAL SLICER	TRANCHEUSES MANUELLES A VOLANT	SCHWUNGRAD-AUFSCHNITTMASCHINE	CORTADORAS CON VOLANTE	СЛАЙСЕРЫ С ПРИВОДОМ ОТ МАХОВИКА	226
AFFETTATRICI	SLICERS	TRANCHEUSES	AUFSCHNITTMASCHINEN	CORTADORAS DE FIAMBRE	СЛАЙСЕРЫ	228
ASCIUGA LUCIDA POSATE	CUTLERY DRYER-POLISHER	MACHINES À ESSUYER ET POLIR LES COUVERTS	BESTECKTROCKNER POLIERER	SECADORAS ABRILLANTADORAS DE CUBIERTOS	СУШИЛЬНОПОЛИРОВОЧНАЯ МАШИНА ДЛЯ СТОЛОВЫХ ПРИБОРОВ	244
TERMOSIGILLATRICI	HEAT SEALERS	THERMOSCELLEUSES	THERMOVERSIEGELUNGS-GERÄTE	TERMOSELLADORAS	ТЕРМОЗАПЕЧАТЫВАЮЩАЯ МАШИНА	246
MACCHINE SOTTOVUOTO A CAMPANA	CHAMBER VACUUM PACKERS	MACHINES SOUS VIDE À CLOCHE	KAMMER-VAKUUMVERPACKER	ENVASADORAS AL VACÍO	КОЛПАКОВЫЕ ВАКУУМНЫЕ УПАКОВОЧНЫЕ МАШИНЫ	254
MACCHINE SOTTOVUOTO A BARRA SALDANTE	BAR VACUUM PACKERS	MACHINES SOUS VIDE À BARRE	VAKUUMVERPACKER MIT SCHWEISSLEISTE	ENVASADORAS AL VACÍO CON BARRA	ВАКУУМНЫЕ УПАКОВОЧНЫЕ МАШИНЫ СО СВАРОЧНОЙ ПЛАНКОЙ	260
COTTURA SOUS-VIDE	SOUS-VIDE COOKING	CUISSON SOUS-VIDE	VAKUUM GAREN	COCCIÓN SOUS-VIDE	ВАКУУМНАЯ ВАРКА	268
FORNI PIZZA ELETTRICI	ELECTRIC PIZZA OVENS	FOURS À PIZZA ÉLECTRIQUES	ELEKTRISCHE PIZZAÖFEN	HORNOS ELÉCTRICOS PARA PIZZA	ЭЛЕКТРИЧЕСКИЕ ПЕЧИ ДЛЯ ПИЦЦЫ	270
FORNETTO PER PIZZA	PIZZA OVEN	FOUR À PIZZA	PIZZAOFEN	HORNO PARA PIZZA	ПЕЧКА ДЛЯ ПИЦЦЫ	286
FORNI PIZZA A GAS	GAS PIZZA OVENS	FOURS À PIZZA À GAZ	GAS PIZZAÖFEN	HORNOS A GAS PARA PIZZA	ПЕЧИ ДЛЯ ПИЦЦЫ	288
CELLE DI LIEVITAZIONE PER FORNI PIZZA	PROVING CELLS FOR PIZZA OVENS	CELLULES DE FERMENTATION CONTROLÉE POUR FOURS À PIZZA	GÄRZELLEN FÜR PIZZAÖFEN	CÉLULAS DE FERMENTACIÓN PARA HORNOS DE PIZZA	ЯЧЕЙКИ РАССТРОЕЧНЫЕ ПЕЧЕЙ ДЛЯ ПИЦЦЫ	292
CAPPE ASPIRANTI FORNI PIZZA	HOODS FOR PIZZA OVENS	HOTTES POUR FOURS À PIZZA	DUNSTABZUGSHAUBEN FÜR PIZZAÖFEN	CAMPANAS EXTRACTORAS PARA HORNOS DE PIZZA	ВЫТЯЖНЫЕ КОЛПАКИ ДЛЯ ПЕЧЕЙ ДЛЯ ПИЦЦЫ	296
FORNO COMBINATO	COMBI OVEN	FOUR COMBINÉ	KOMBI-DÄMPFER	HORNO COMBI	ПАРОКОНВЕКТОМАТ	298
FORNI MISTI A CONVEZIONE	MECHANICAL CONVECTION OVENS	FOURS À CONVECTION MÉCANIQUE	MECHANISCHE KOMBIÖFEN	HORNOS DE CONVECCIÓN MECÁNICA	МЕХАНИЧЕСКИЕ КОНВЕКЦИОННЫЕ ПЕЧИ	300
ARMADI LIEVITATORI	PROVING CABINET FOR OVENS	ARMOIRES DE LEVAGE POUR FOURS	GÄRSCHRÄNKE FÜR ÖFEN	ARMARIOS FERMENTADORES PARA HORNOS	ЯЧЕЙКИ РАССТРОЕЧНЫЕ ДЛЯ ПЕЧЕЙ	312
CUCINE A GAS	GAS RANGES	CUISINIÈRES À GAZ	GASHERD	COCINAS A GAS	ГАЗОВАЯ ПЛИТА	334
FRIGGITRICI ELETTRICHE	ELECTRIC FRYERS	FRITEUSES ÉLECTRIQUES	ELEKTRISCHE FRITEUSEN	FREIDORAS ELÉCTRICAS	ЭЛЕКТРИЧЕСКИЕ ФРИТЮРНИЦЫ	338
FRIGGITRICI A GAS	GAS FRYERS	FRITEUSES À GAZ	GAS FRITEUSEN	FREIDORAS A GAS	ГАЗОВЫЕ ФРИТЮРНИЦЫ	346
CUOCIPASTA ELETTRICI	ELECTRIC PASTA COOKERS	CUISEURS À PÂTE ÉLECTRIQUES	ELEKTRO NUDELKOCHER	COCEDORES DE PASTA ELÉCTRICOS	ЭЛЕКТРИЧЕСКИЕ МАКАРОНОВАРКИ	352
CUOCIPASTA A GAS	GAS PASTA COOKERS	CUISEURS À PÂTE À GAZ	GAS NUDELKOCHER	COCEDORES DE PASTA DE GAS	ГАЗОВЫЕ МАКАРОНОВАРКИ	354
GRIGLIE A PIETRA LAVICA	LAVA STONE GRILL	GRILLES À PIERE LAVIQUE	LAVASTEINGRILL	PARRILLAS DE PIEDRA LÁVICA	ГРИЛЬ С ЛАВОВЫМ КАМНЕМ	358
FRY TOP ELETTRICI	ELECTRIC FRY-TOPS	FRY-TOP ÉLECTRIQUE	ELEKTRISCHE FRY TOP	FRY TOP ELÉCTRICOS	ЭЛЕКТРИЧЕСКИЕ ЖАРОЧНЫЕ ПОВЕРХНОСТИ	362
FRY TOP GAS	GAS FRY TOP	FRY TOP A GAZ	GAS FRY TOP	FRY TOP A GAS	ГАЗОВЫЕ ЖАРОЧНЫЕ ПОВЕРХНОСТИ	365
GYROS ELETTRICI	ELECTRIC GYROS	GYROS ÉLECTRIQUES	ELEKTRISCHER GYROS	GYROS ELÉTRICOS	ЭЛЕКТРИЧЕСКИЕ ВЕРТИКАЛЬНЫЕ ШАШЛЫЧНИЦЫ	368
GYROS A GAS	GAS GYROS	GYROS A' GAZ	GAS GYROS	GYROS DE GAS	ГАЗОВЫЕ ВЕРТИКАЛЬНЫЕ ШАШЛЫЧНИЦЫ	371
SALAMANDRE	SALAMANDERS	SALAMANDER	SALAMANDER	SALAMANDRAS	ГРИЛЬ САЛАМАНДР	374

IT	EN	FR	DE	ES	RU	
FRULLATORI	MIXERS	MIXEURS	MIXER	BATIDORAS	БЛЕНДЕРЫ	378
FRULLATORI FRAPPÈ	MILKSHAKER	BLENDERS À FRAPPÉS	MILKSHAKERS	LICUADORAS FRAPPÉ	БЛЕНДЕРЫ ДЛЯ ПРИГОТОВЛЕНИЯ ФРАППЕ	382
SPREMIAGRUMI	JUICE SQUEEZER	PRESSE-AGRUMES	ZITRUSPRESSE	EXPRIMIDOR	СОКОВЫЖИМАЛКИ ДЛЯ ЦИТРУСОВЫХ	384
TRITAGHIACCIO	ICE CRUSHER	BROYEUR À GLACE	EISMÜHLE	PICADORA DE HIELO	ЛЕДОВАЯ ДРОБИЛКА	386
GRUPPI MULTIPLI	MULTIPLE GROUP	GROUPE MULTIPLE	MULTI-EINHEIT	GRUPO MÚLTIPLE	БАРНЫЙ КОМБАЙН	388
TOSTIERE	TOASTER	TOASTEUR	TOASTER	PARILLA-TOSTADORA DE BANDEJA	ТОСТЕР	390
TOSTAPANE CONTINUO	CONTINUOUS TOASTER	GRLLE-PAIN CONTINU	DURCHLAUF-TOASTER	TOSTADORA DE PAN CONTINUA	НЕПРЕРЫВНЫЙ ТОСТЕР	394
PIASTRE ELETTRICHE IN VETROCERAMICA	PYROCERAM GRILLS	PLAQUE EN VITROCÉRAMIQUE	GLASKERAMIKPLATTEN	PLACAS DE VITROCERÁMICA	СТЕКЛОКЕРАМИЧЕСКАЯ ПЛИТА	396
PIASTRE ELETTRICHE IN GHISA	CAST IRON ELECTRICAL GRILLS	PLAQUES ELECTRIQUES EN FONTE	GUSSEISENELEKTROPLATTEN	PLACAS ELÉCTRICAS DE FUNDICIÓN	ЭЛЕКТРИЧЕСКИЕ ПЛИТЫ	399
CREPIERE ELETTRICHE	ELECTRIC CRÊPES MACHINES	CRÊPIÈRES ÉLECTRIQUES	ELEKTRISCHE CRÊPES-MASCHINEN	MÁQUINA PARA CREPES ELÉCTRICA	ЭЛЕКТРИЧЕСКИЕ - ГАЗОВЫЕ БЛИННИЦЫ	402
CREPIERE A GAS	GAS CRÊPES MACHINES	CRÊPIÈRES À GAZ	GAS CRÊPES-MASCHINEN	MÁQUINA PARA CREPES DE GAS	ГАЗОВЫЕ БЛИННИЦЫ	404
CUOCI HOT DOG	HOT DOG	HOT DOG	HOT DOG	PERRITO CALIENTE	АППАРАТ ДЛЯ ПРИГОТОВЛЕНИЯ ХОТ-ДОГОВ	406
PRESSAGELATO	ICE CREAM PRESS	PRESSE-GLACE	EISPRESSE	PRENSADOR PARA HELADO	ПРЕСС ДЛЯ МОРОЖЕНОГО	408
LAVABICCHIERI	GLASSWASHER	LAVE-VERRES	GLÄSPÜLMASCHINE	LAVAVASOS	ПОСУДОМОЕЧНАЯ МАШИНА	412
LAVASTOVIGLIE	DISHWASHER	LAVE-VAISSELLES	SPÜLMASCHINE	LAVAVAJILLA	ПОСУДОМОЕЧНАЯ МАШИНА	418

Indice







INDEX
TABLE DES MATIÈRES
INHALTSVERZEICHNIS
ÍNDICE
СОДЕРЖАНИЕ



CODICE / CODE	
115C2PN	75
12AT	60
12B	50
12CE	44
12CNS0	New 100
12FN0	New 103
12S	48
12SB	122
12SL	119
12SN0	New 108
12SR	116
12T	62
12TS	46
150C2PN	75
15LN	112
18CNS0	New 100
18FN0	New 103
18SB	122
18SL	119
18SN0	New 108
18SR	116
20LN	112

CODICE / CODE	
22AE	58
22AT	52
22ATE	54
22CE	42
22REFI	22
22RG	32
22RGE	32
22RS	34
22RSE	34
22SN	38
22T	56
22TE	40
22TS	36
22TSE	36
25CNS0	New 100
25FN0	New 103
25SB	122
25SL	119
25SN0	New 108
25SR	116
30C1PN	75
30LN	112

CODICE / CODE	
32REFI	22
32RS	28
32RSD	28
32RSE	28
32TN	24
32TND	24
32TNE	24
38CNS0	New 100
38FN0	New 103
38SB	122
38SL	119
38SN0	New 108
38SR	116
3CLEAN	332
40LN	112
50C1PN	75
50C2PN	75
50CNS0	New 100
50FN0	New 103
50SB	122
50SL	119
50SN0	New 108

CODICE / CODE	
50SR	116
75C1PN	75
7SB	106
95C2PN	75
AB8D	66
ACCAPSLIM23M	314
ACCAPSTR	314
ACCAPTOP	314
ACCAPTOPT	314
ACCAVPF80EN0	95
ACCOLPF15N1	95
ACCOLPFN1	95
ACGRI332V	321
ACGRICMP4534	321
ACGRIFISH	359
ACKITLAV	315
ACLACT35-ACLACT40	422
ACLAVCQ35-ACLAVCQ40	422
ACLAVCTSUP35 ACLAVCTSUP40	422
ACLAVDETS-ACLAVDETH ACLAVBRILLS-ACLAVBRILLH	423
ACLAVPOS	422
ACTE332V	321

CODICE / CODE		CODICE / CODE		CODICE / CODE		CODICE / CODE	
ACTE423V	321	BERTA15	150	CC74P	334	CRP2N	402
ACTRMPF	92	BERTA25	150	CC76G	334	CRP4	402
ALP3000	244	BERTA35	150	CC76GFEV	334	CRP42	402
ARMINIT 	158	BERTA7	150	CC76GFG	334	CRPN	402
AV4937	332	BP	422	CL3N	200	ECO220	228
AV4940	332	BV-BVM	422	CL5N	200	ECO250	228
AV4980	332	CAM300ED 	258	CL5NV2	200	ECO300	228
AV6007N	94	CAM300TD 	256	CL8N	200	ECO300L	230
AVB4940	332	CAM350ED 	258	CL8NV2	200	ECO330	230
AVC4940	332	CAM400ED 	258	CLFML-CLFMLW-CLFYL CLFMD-CLFMDW CLMINI-CLFGI4-CLFGI6 CLFGI9-CLFME-CLFES	292	FES	278
AVF4940	332	CAM400TD 	256	CMP332M	320	FF30N	154
B115	361	CAM450ED 	258	CMP423D	316	FGI4	288
B50	361	CAM500TC	254	CMP423M	320	FGI6	288
B80	361	CAM500TD 	256	CMP4GPD	316	FGI9	288
B9-B16-B125-B136-B49	423	CAM700TC	254	CMP4GPM	318	FI32N	160
BA	422	CAM900TC	254	CMP4GPMI	318	FI42N	160
BAR300P	260	CAPPAFML-CAPPAFMLW CAPPAFYL-CAPPAFMD CAPPAFMDW-CAPPAFME CAPPAFMEW	296	COPCEST	422	FIM42N	162
BAR350	260	CARFORFF30N0	156	CP11N	352	FIP42N	160
BAR400	260	CARPF	94	CP8	422	FMD	270
BAR500	260	CAV40FORFF30N0	156	CPM30	352	FMDW	270
BC3N	204	CAVFO	290	CPM30DM	354	FME	274
BC5N	204	CC74G	334	CPM30M	354	FMEW	274
BC5NV	204	CC74GFEV	334	CR400G1	404	FML	274
BC8N	204	CC74GFG	334	CR400G2	404	FMLW	274
BC8NV	204					FN423E	326

CODICE / CODE		CODICE / CODE		CODICE / CODE		CODICE / CODE	
FN423EV	326	FR200P	378	FRY2VCE	362	GP65	332
FN423G	330	FR2150I	378	FX40	182	GR12S	64
FN423GV	330	FR2150P	378	FYL	278	GR8D	66
FN423M	328	FR44N	338	G220	 233	GRI11	332
FN423MV	328	FR4N	334	G250	 233	GRI23	332
FOALCMP423	322	FR88N	338	G275	 233	GRI64	332
FOALCMP4GP	322	FR88RN	338	G300	 233	GYR100	368
FOALTOP10T	312	FR8N	338	G350	 233	GYR40	368
FOALTOP64T	312	FR8RN	338	GL33	358	GYR60	368
FOALTOPSTR	312	FRY1L	362	GL66	358	GYR60M	368
FOCAVCMP423	324	FRY1LC	362	GNI1120	332	GYR80	368
FOCAVCMPGP	324	FRY1LM	365	GNI1140	332	GYR80M	368
FOCAVSLIM	315	FRY1LMC	365	GNI1165	332	GYR80MD	368
FOCAVSTR	315	FRY1R	362	GNI2320	332	H220N	236
FOCAVTOP10	315	FRY1RC	362	GNI2340	332	H250N	236
FOCAVTOP64	315	FRY1RM	365	GNI2365	332	H275N	236
FP	286	FRY1RMC	365	GNI2365	332	H300N	236
FP11	382	FRY2L	362	GNS1120	332	H330	236
FP1P	382	FRY2LC	362	GNS1140	332	H350	236
FP2I	382	FRY2LM	365	GNS1165	332	H370	236
FP2P	382	FRY2LMC	365	GP2FR	388	HL300	234
FR1010RN	338	FRY2LR	362	GP2SF	388	HR250	234
FR10RN	338	FRY2LRC	362	GP37	332	HR300N	234
FR150I	378	FRY2LRM	365	GP38	332	HYD12SBD	 146
FR150P	378	FRY2LRMC	365	GP3SFF	388	HYD12SBM	136

CODICE / CODE		
HYD12SLD	New	143
HYD12SLM		133
HYD12SRD	New	140
HYD12SRM		130
HYD18SBD	New	146
HYD18SBM		136
HYD18SLD	New	143
HYD18SLM		133
HYD18SRD	New	140
HYD18SRM		130
HYD25SBD	New	146
HYD25SBM		136
HYD25SLD	New	143
HYD25SLM		133
HYD25SRD	New	140
HYD25SRM		130
HYD38SBD	New	146
HYD38SBM		136
HYD38SLD	New	143
HYD38SLM		133
HYD38SRD	New	140
HYD38SRM		130
HYD50SBD	New	146
HYD50SBM		136
HYD50SLD	New	143

CODICE / CODE		
HYD50SLM		133
HYD50SRD	New	140
HYD50SRM		130
K300		242
K330		242
K350		242
K370		242
LABI35N		412
LABI35PLN		412
LABI40N		412
LABI40PLN		412
LAPI50CN		415
LAPI50CPLN		415
LAPI50N		415
LAPI50PLN		415
LAV		224
LAVAB50		359
LCF10M		218
LCF18M		220
LCF5		216
LCN10M		218
LCN18M		220
LCN5		216
LT14OR		78
LT14VE		78

CODICE / CODE		
LT7OR		78
LT7VE		78
MICRO1C		282
MICRO2C		282
MICROV18C		284
MICROV1C		282
MICROV22C		284
MICROV2C		282
MINI		282
MPF15N		88
MPF25CN		88
MPF25N		88
MPF4N		90
MPF8N		90
MSD300P		260
MX20		178
MX20V2		178
MX20VV		178
MX25		180
MX40		182
PE25NL		399
PE25NR		399
PE35NL		399
PE35NR		399
PE50NL		399

CODICE / CODE		
PE50NM		399
PE50NR		399
PF15E		84
PF25E		84
PF40E		86
PF80E		86
PGEL		406
PLN12BV		168
PLN20BV		168
PLN20M		171
PLN20V		168
PLN40D		166
PLN40M		171
PLN40V		168
PLN60D		166
PLN60M		171
PLN60V		168
PLN80D		166
PLN80V		168
PPF10M		210
PPF18M		212
PPF25		214
PPF5		208
PPN10M		210
PPN18M		212

CODICE / CODE	
PPN25	214
PPN5	208
PRESSAF10	80
PRESSAF13	80
PV27LL	396
PV27LR	396
PV40LL	396
PV40LR	396
PV55LL	396
PV55LR	396
RAPIDO	298
RH60 	269
RIA9-RIA16-RIA25 RIA36-RIA49-RIA100	422
ROGM	386
RS40	374
RS70	374
SAL600MB	374
SE1550A	72
SE1550V	72
SE1830A	72
SE1830V	72
SE2020A	72
SE2020V	72
SF10DM	346
SF10M	346

CODICE / CODE	
SF25P	344
SFM18	342
SFM18D	342
SFM20DM	346
SFM20M	346
SI320	164
SI420	164
SI520	164
SLIM623D	300
SLIM623M	302
SLIM6D	300
SLIM6M	302
SPL	384
SPM	384
STR10	310
STR6	310
SV25	269
TAC	196
TAS	196
TOC	394
TOCS	394
TOP10DN	306
TOP10M	308
TOP10TN	304
TOP2DN 	390

CODICE / CODE	
TOP3DN	390
TOP4DN	306
TOP4M	308
TOP4TN	304
TOP6DN	306
TOP6DN	390
TOP6M	308
TOP6TN	304
TR8D	66
TRL	386
TS1	250
TS1A	250
TS2	250
TS2A	250
TS300	246
TS3A	248
TS400	246
TV2000RN	188
TV2500	190
TV3000N	190
TV4000	186
V250	239
V330	239
V350	239
V370	239

CODICE / CODE	
VM300	239
VR300N	239
VW300	226
VW350	226
WD3	406

Condizioni generali di vendita

GENERAL SALES CONDITIONS
CONDITIONS GÉNÉRALES DE VENTE
ALLGEMEINE VERKAUFSBEDINGUNGEN
CONDICIONES GENERALES DE VENTA
ОБЩИЕ УСЛОВИЯ ПРОДАЖИ

IT

COSTO DELL' IMBALLO: compreso nel prezzo per le macchine. Per ricambi ed accessori è previsto un contributo di € 8,00; cassa in legno con coperchio per piane refrattarie, il contributo è di € 54,00.

COSTO FISSO GESTIONE ORDINI: € 10,00 solo per ordini di importo inferiore a € 100,00.

ORDINI: gli ordini devono essere trasmessi esclusivamente in forma scritta; nuovi ordini o eventuali modifiche trasmesse in forma orale non verranno accettate.

CONDIZIONI DI PAGAMENTO: Si richiede il pagamento con bonifico bancario per: 1. Prime forniture. - 2. Al superamento del fido. - 3. Invio di ricambi.

DILAZIONI DI PAGAMENTO: da definire.

Sulle somme pagate in ritardo rispetto alla scadenza pattuita, saranno addebitati gli interessi di mora al tasso legale. Eventuali note di accredito saranno detratte nella fattura successiva.

PREZZI: non sono impegnativi, possono subire variazioni senza obbligo di preavviso, in tal caso saranno confermati all'ordine. Tutti i prezzi sono esclusi di IVA.

TERMINI DI CONSEGNA: 1. Per l'Italia, possibile spedizione in 24 ore per macchine disponibili a magazzino. 2. Per macchine da produrre considerare circa 25 giorni salvo imprevisti.

TRASPORTO: FRANCO FABBRICA, la merce viaggia a rischio e pericolo del committente, per cui Fimar S.p.a. non è responsabile per eventuali danni subiti dalla merce durante il trasporto. Eventuali contestazioni dovranno essere effettuate all'atto della consegna entro i termini di legge.

ASSISTENZA TECNICA: a carico del rivenditore per tutta la durata della garanzia di anni uno. Fimar S.p.a. si impegna a fornire, in garanzia, tutti i componenti di ricambio ritenuti difettosi. Il prezzo di vendita fatturato all'utilizzatore finale comprenderà non solo il prezzo dei prodotti finiti venduti, ma anche la gestione da parte del rivenditore della garanzia a copertura di essi. Fimar S.p.a. non dovrà sostenere alcuna spesa diretta o indiretta sostenuta dal rivenditore per la gestione della garanzia. La garanzia decade sul prodotto danneggiato o compromesso da un uso scorretto o comunque non conforme.

INSTALLAZIONE: installazione ed istruzione sull'utilizzo delle macchine e dei suoi accessori sono a carico del rivenditore.

RIPARAZIONI: nel caso in cui un preventivo di riparazione non venga accettato verranno addebitati € 25,00 quale concorso spese dei costi di gestione.

GARANZIA: 12 mesi.

RESI: per eventuali resi autorizzati di merce con imballo integro, sarà trattenuta una quota pari al 15% del valore, con un minimo di € 50.

ASSICURAZIONE: tutte le nostre macchine sono coperte da assicurazione (responsabilità civile verso terzi) Escluso U.S.A. e CANADA.

CATALISTINO: la presente documentazione annulla tutte le precedenti. I dati tecnici, le illustrazioni e le immagini riportate nella presente, sono puramente indicativi. La Ditta si riserva il diritto di modificare le caratteristiche tecniche ed estetiche o sospendere, in ogni momento, la propria produzione senza obbligo di preavviso.

IMMAGINI ED ILLUSTRAZIONI: tutte le immagini realizzate dal produttore sono coperte da copyright. L'utilizzo o la riproduzione delle medesime sono soggette ad autorizzazione da parte della Ditta proprietaria del marchio e detentrica dei diritti di proprietà materiale ed intellettuale. I prezzi o i dati tecnici potranno subire variazioni nel caso di errori tipografici o di cambiamenti in corso d'opera.

MARCHI E BREVETTI: è fatto espresso divieto di utilizzare i marchi e/o i brevetti registrati dalla Fimar S.p.a. Si precisa che tutti i macchinari e gli accessori non marcati CE presentano caratteristiche specifiche che non li rendono idonei alla vendita all'interno dei paesi dell'Unione Europea.

RICHIESTA DI DOCUMENTAZIONE TECNICA AGGIUNTIVA: Copia conforme all'originale della Certificazione CE: € 20,00 + spese di spedizione - Copia cartacea del Manuale d'Uso e Manutenzione: € 40,00 + spese di spedizione.

MOD165V02 - FINITO DI STAMPARE NEL SETTEMBRE 2025

EN

PACKAGING COSTS: included in the price for equipment. Spare parts and accessories are subject to a surcharge of €8.00. Wooden crate with lid for refractory plates is subject to a surcharge of €54.00.

FIXED COST OF ORDER MANAGEMENT: € 10.00 only on orders of less than € 100.00.

ORDERS: Orders must be transmitted in written form only; new orders or any changes transmitted in verbal form will not be accepted.

PAYMENT TERMS: Payment by bank transfer is required for: 1. First deliveries. - 2. On exceeding the credit limit. - 3. Shipment of spare parts.

PAYMENT DEFERRALS: To be defined.

Interest at the legal rate shall be charged on sums paid late with respect to the agreed due date. Any credit notes will be deducted from the next invoice.

PRICES: these are not binding, they may vary without prior notice, in which case they will be confirmed on the order. Prices are VAT excluded.

DELIVERY TERMS: 1. For Italy, possible shipment within 24 hours for machines in stock. 2. For machines to be produced, please allow approximately 25 days, barring unforeseen circumstances.

SHIPMENT: EX WORKS, goods travel at the customer's risk, therefore Fimar S.p.a. is not responsible for any damage suffered by the goods during transport. Any claims must be made at the time of delivery within the legal terms.

TECHNICAL ASSISTANCE: charged to the dealer for the entire duration of the warranty of one year. Fimar S.p.a. undertakes to supply, under warranty, all spare parts deemed defective. The sales price invoiced to the end user shall include not only the price of the finished products sold, but also the dealer's handling of the warranty covering them. Fimar S.p.a. shall not incur any direct or indirect expenses borne by the retailer for the management of the warranty. The warranty shall be void if the product is damaged or impaired by incorrect or otherwise non-compliant use.

INSTALLATION: installation and instruction in the use of the machine and its accessories are the responsibility of the dealer.

REPAIRS: in the event that a repair quote is not accepted, € 25.00 will be charged as a contribution towards operating costs.

WARRANTY: 12 months.

RETURNS: for any authorised returns of goods with undamaged packaging, a fee of 15% of the value will be withheld, with a minimum of € 50.

INSURANCE: all our machines are covered by insurance (third party liability) Excluding U.S.A. and CANADA.

CATALOGUE: this document invalidates all previous ones. The technical data, illustrations and pictures in this document are purely indicative. The Company reserves the right to modify the technical and aesthetic characteristics or discontinue its production at any time without prior notice.

IMAGES AND ILLUSTRATIONS: All images taken by the manufacturer are covered by copyright. Their use or reproduction is subject to authorisation by the company that owns the trademark and holds the material and intellectual property rights. Prices or technical data may be subject to change in the event of typographical errors or changes.

TRADEMARK AND PATENTS: It is expressly forbidden to use the trademarks and/or patents registered by Fimar S.p.a.. Please note that all machinery and accessories that are not CE marked have specific characteristics that make them unsuitable for sale within the countries of the European Union.

REQUEST FOR ADDITIONAL TECHNICAL DOCUMENTATION: Copy conforming to the original of the CE Certification: € 20.00 + shipping costs - Hard copy of the Use and Maintenance Manual: € 40.00 + shipping costs.

MOD165V02 - PRINTED IN SEPTEMBER 2025

FR

FRAIS D'EMBALLAGE: inclus dans le prix des machines. Pour les pièces détachées et les accessoires, il faut compter une contribution de 8,00 €; pour la caisse en bois pour les plaques réfractaires avec couvercle, la contribution est de 54,00 €.

FRAIS FIXES DE GESTION DES COMMANDES: 10,00 € uniquement pour les commandes inférieures à 100,00 €.

COMMANDES: Les commandes doivent être transmises uniquement par écrit; les nouvelles commandes ou les modifications transmises oralement ne seront pas acceptées.

CONDITIONS DE PAIEMENT: Le paiement par virement bancaire est exigé pour: 1. les premières livraisons - 2. en cas de dépassement de la limite de crédit - 3. L'envoi de pièces détachées.

RETARDS DE PAIEMENT: à définir.

Les sommes payées en retard par rapport à la date d'échéance convenue sont majorées d'un intérêt au taux légal. Les avoirs éventuels seront déduits de la facture suivante.

PRIX: ils ne sont pas contractuels, ils peuvent varier sans préavis, auquel cas ils seront confirmés lors de la commande. Tous les prix s'entendent hors TVA.

CONDITIONS DE LIVRAISON: 1) Pour l'Italie, expédition possible dans les 24 heures pour les machines en stock. 2) Pour les machines à produire, il faut compter environ 25 jours, sauf imprévus.

TRANSPORT: EX WORKS, la marchandise voyage aux risques et périls du client, par conséquent Fimar S.p.a. n'est pas responsable des éventuels dommages subis par la marchandise pendant le transport. Toute réclamation doit être faite au moment de la livraison dans les délais légaux.

ASSISTANCE TECHNIQUE: à la charge du revendeur pendant toute la durée de la garantie d'un an. Fimar S.p.a. s'engage à fournir, sous garantie, toutes les pièces de rechange jugées défectueuses. Le prix de vente facturé à l'utilisateur final comprend non seulement le prix des produits finis vendus, mais aussi la prise en charge par le revendeur de la garantie qui les couvre. Fimar S.p.a. ne supportera pas les frais directs ou indirects encourus par le revendeur pour la gestion de la garantie. La garantie est annulée si le produit est endommagé ou détérioré à la suite d'une utilisation incorrecte ou non conforme.

INSTALLATION: l'installation et la formation à l'utilisation de l'appareil et de ses accessoires sont à la charge du revendeur.

RÉPARATIONS: en cas de refus d'un devis de réparation, 25,00 € seront facturés à titre de participation aux frais d'exploitation.

GARANTIE: 12 mois.

RETOURS: pour tout retour autorisé de marchandises dans un emballage intact, une retenue de 15% de la valeur sera effectuée, avec un minimum de 50 €.

ASSURANCE: toutes nos machines sont couvertes par une assurance (responsabilité civile), à l'exclusion des États-Unis et du Canada.

CATALOGUE LISTE: Ce document annule tous les documents précédents. Les données techniques, les illustrations et les photos contenues dans ce document sont purement indicatives. La société se réserve le droit de modifier les caractéristiques techniques et esthétiques ou d'arrêter la production à tout moment et sans préavis.

IMAGES ET ILLUSTRATIONS: Toutes les images prises par le fabricant sont couvertes par le droit d'auteur. Leur utilisation ou leur reproduction est soumise à l'autorisation de la société propriétaire de la marque et détentrice des droits matériels et de propriété intellectuelle. Les prix ou les données techniques peuvent être modifiés en cas d'erreurs typographiques ou de changements.

MARQUES ET BREVETS: Il est expressément interdit d'utiliser les marques et/ou les brevets déposés par Fimar S.p.a.. Il est à noter que les machines et les accessoires non marqués CE présentent des caractéristiques spécifiques qui les rendent impropres à la vente dans les pays de l'Union européenne.

DEMANDE DE DOCUMENTATION TECHNIQUE SUPPLÉMENTAIRE: Copie conforme à l'original de la certification CE: 20,00 € + frais d'expédition - Copie papier du manuel d'utilisation et d'entretien: 40,00 € + frais d'expédition.

MOD165V02 - IMPRESSION TERMINÉE EN SEPTEMBRE 2025

DE

VERPACKUNGSKOSTEN: im Gerätepreis enthalten. Für Ersatzteile und Zubehör werden 8,00 € als Beitrag erhoben; für die Holzkiste für feuerfeste Platten mit Deckel beträgt der Beitrag 54,00 €.

FESTE KOSTEN FÜR DIE BESTELLUNGSVERWALTUNG: 10,00 € nur für Bestellungen unter 100,00 €.

AUFTRÄGE: Aufträge sind ausschließlich in schriftlicher Form zu übermitteln; mündlich übermittelte Neuaufrträge oder Änderungen werden nicht angenommen.

ZAHLUNGSBEDINGUNGEN: Die Zahlung per Banküberweisung ist erforderlich: 1. bei der ersten Lieferung. - 2. bei Überschreitung des Kreditlimits. - 3. bei Versand von Ersatzteilen.

ZAHLUNGSVERZÖGERUNGEN: zu bestimmen.

Auf verspätet gezahlte Beträge werden Verzugszinsen in Höhe des gesetzlichen Zinssatzes erhoben. Eventuelle Gutschriften werden mit der nächsten Rechnung verrechnet.

PREISE: Sie sind unverbindlich und können ohne vorherige Ankündigung geändert werden; in diesem Fall werden sie auf der Bestellung bestätigt. Alle Preise verstehen sich ohne Mehrwertsteuer.

LIEFERBEDINGUNGEN: 1. für Italien, möglicher Versand innerhalb von 24 Stunden für Geräte auf Lager. 2) Für Geräte, die hergestellt werden sollen, beträgt die Lieferzeit etwa 25 Tage, sofern keine unvorhergesehenen Umstände eintreten.

TRANSPORT: AB WERK, die Ware reist auf Risiko des Kunden, daher ist Fimar S.p.a. nicht für eventuelle Schäden an der Ware während des Transports verantwortlich. Eventuelle Reklamationen müssen zum Zeitpunkt der Lieferung innerhalb der gesetzlichen Fristen geltend gemacht werden.

TECHNISCHE UNTERSTÜTZUNG: zu Lasten des Händlers für die gesamte Dauer der Garantie von einem Jahr. Fimar S.p.a. verpflichtet sich, im Rahmen der Garantie alle Ersatzteile zu liefern, die als defekt gelten. Der dem Endverbraucher in Rechnung gestellte Verkaufspreis umfasst nicht nur den Preis für die verkauften Endprodukte, sondern auch die Abwicklung der Garantie durch den Händler. Fimar S.p.a. übernimmt keine direkten oder indirekten Kosten, die dem Wiederverkäufer durch die Abwicklung der Garantie entstehen. Die Garantie erlischt, wenn das Produkt durch unsachgemäßen oder anderweitig nicht konformen Gebrauch beschädigt oder beeinträchtigt wird.

INBETRIEBNAHME: Die Inbetriebnahme und die Einweisung in den Gebrauch des Geräts und seines Zubehörs liegen in der Verantwortung des Händlers.

REPARATUREN: Falls ein Kostenvoranschlag für eine Reparatur nicht akzeptiert wird, werden 25,00 € als Beitrag zu den Betriebskosten berechnet.

GARANTIE: 12 Monate.

RÜCKGABE: Für jede genehmigte Rücksendung von Waren mit unbeschädigter Verpackung wird eine Gebühr von 15 % des Wertes einbehalten, mindestens jedoch 50 €.

VERSICHERUNG: Alle unsere Geräte sind versichert (Haftpflicht), ausgenommen USA und KANADA.

KATALOG-PREISLISTE: Dieses Dokument ersetzt alle vorherigen Dokumente. Die technischen Daten, Illustrationen und Bilder in diesem Dokument sind rein indikativ. Das Unternehmen behält sich das Recht vor, die technischen und ästhetischen Merkmale zu ändern oder die Produktion jederzeit und ohne Vorankündigung einzustellen.

BILDER UND ILLUSTRATIONEN: Alle vom Hersteller aufgenommenen Bilder sind urheberrechtlich geschützt. Ihre Verwendung oder Vervielfältigung unterliegt der Genehmigung des Unternehmens, das Eigentümer der Marke und Inhaber der materiellen und geistigen Eigentumsrechte ist. Preise oder technische Daten können im Falle von Druckfehlern oder Änderungen geändert werden.

MARKEN UND PATENTE: Es ist ausdrücklich verboten, die von Fimar S.p.a. eingetragenen Marken und/oder Patente zu verwenden. Wir weisen darauf hin, dass alle Maschinen und Zubehörteile, die nicht mit der CE-Kennzeichnung versehen sind, besondere Merkmale aufweisen, die sie für den Verkauf in den Ländern der Europäischen Union ungeeignet machen.

ANFORDERUNG VON ZUSÄTZLICHEN TECHNISCHEN DOKUMENTEN: Kopie, die dem Original der CE-Zertifizierung entspricht: € 20,00 + Versandkosten - Ausdruck der Bedienungs- und Wartungsanleitung: € 40,00 + Versandkosten.

MOD165V02 - FDRUCKFERTIGSTELLUNG IM SEPTEMBER 2025

ES

GASTOS DE EMBALAJE: incluidos en el precio de los equipos. Para las piezas de repuesto y accesorios hay una contribución de 8,00 €; caja de madera para placas refractarias con tapa la contribución es de 54,00 €.

GASTOS FIJOS DE GESTIÓN DE PEDIDOS: 10,00 euros sólo para pedidos inferiores a 100,00 euros.

PEDIDOS: Los pedidos deben transmitirse únicamente por escrito; no se aceptarán nuevos pedidos ni modificaciones transmitidas verbalmente.

CONDICIONES DE PAGO: El pago por transferencia bancaria es obligatorio para: 1. Primeras entregas. - 2. Al superar el límite de crédito. - 3. Envío de piezas de recambio.

ATRASOS EN EL PAGO: A definir.

Se cobrarán intereses al tipo legal sobre las cantidades pagadas con retraso respecto a la fecha de vencimiento acordada. Los abonos se descontarán de la siguiente factura.

PRECIOS: no son vinculantes, pueden variar sin previo aviso, en cuyo caso se confirmarán en el pedido. Todos los precios son sin IVA.

PLAZOS DE ENTREGA: 1. Para Italia, envío posible en 24 horas para las máquinas en stock. 2. Para las máquinas que deben fabricarse, prevea un plazo aproximado de 25 días, salvo imprevistos.

TRANSPORTE: FRANCO DE PORTE, la mercancía viaja por cuenta y riesgo del cliente, por lo que Fimar S.p.a. no se hace responsable de los posibles daños sufridos por la mercancía durante el transporte. Cualquier reclamación deberá efectuarse en el momento de la entrega dentro de los plazos legales.

ASISTENCIA TÉCNICA: a cargo del concesionario durante toda la duración de la garantía de un año. Fimar S.p.a. se compromete a suministrar, en garantía, todas las piezas de recambio consideradas defectuosas. El precio de venta facturado al usuario final incluirá no sólo el precio de los productos acabados vendidos, sino también la gestión por parte del concesionario de la garantía que los cubre. Fimar S.p.a. no incurrirá en ningún gasto directo o indirecto ocasionado al revendedor por la gestión de la garantía. La garantía quedará anulada si el producto resulta dañado o perjudicado por un uso incorrecto o no conforme.

INSTALACIÓN: la instalación y la instrucción en el uso de la máquina y sus accesorios son responsabilidad del distribuidor.

REPARACIONES: en caso de que no se acepte un presupuesto de reparación, se cobrarán 25,00 euros como contribución a los gastos de funcionamiento.

GARANTÍA: 12 meses.

DEVOLUCIONES: para cualquier devolución autorizada de mercancía con el embalaje intacto, se deducirá una tasa del 15% del valor, con un mínimo de 50 euros.

SEGURO: todas nuestras máquinas están cubiertas por un seguro (responsabilidad civil), excepto EE.UU. y CANADÁ.

CATÁLOGO/LISTA: este documento anula todos los anteriores. Los datos técnicos, ilustraciones y fotografías que figuran en este documento son puramente indicativos. La Empresa se reserva el derecho de modificar las características técnicas y estéticas o de interrumpir su producción en cualquier momento sin previo aviso.

IMÁGENES E ILUSTRACIONES: Todas las imágenes tomadas por el fabricante están protegidas por derechos de autor. Su utilización o reproducción está sujeta a la autorización de la empresa propietaria de la marca y titular de los derechos materiales y de propiedad intelectual. Los precios o datos técnicos pueden estar sujetos a modificaciones en caso de errores tipográficos o cambios.

MARCAS Y PATENTES: Queda expresamente prohibida la utilización de las marcas y/o patentes registradas por Fimar S.p.a.. Se recuerda que todas las máquinas y accesorios que no llevan el marcado CE tienen características específicas que los hacen inadecuados para la venta en los países de la Unión Europea.

SOLICITUD DE DOCUMENTACIÓN TÉCNICA ADICIONAL: Copia conforme al original de la Certificación CE: 20,00 € + gastos de envío - Copia impresa del Manual de Uso y Mantenimiento: 40,00 € + gastos de envío.

MOD165V02 - ACABADO DE IMPRIMIR EN SEPTIEMBRE DE 2025

RU

РАСХОДЫ НА УПАКОВКУ: Включены в стоимость оборудования. Запасные части и аксессуары оплачиваются дополнительно в размере €8,00. Деревянный ящик для огнеупорных плит с крышкой оплачивается дополнительно в размере 54,00 евро.

ФИКСИРОВАННАЯ СТОИМОСТЬ УПРАВЛЕНИЯ ЗАКАЗОМ: € 10,00 только для заказов на сумму менее € 100,00.

ЗАКАЗЫ: Заказы должны передаваться только в письменной форме; новые заказы или любые изменения, переданные в устной форме, не принимаются.

УСЛОВИЯ ОПЛАТЫ: Оплата банковским переводом требуется для: 1. при первых поставках. - 2. при превышении кредитного лимита. - 3. Отгрузки запасных частей.

ОТЛОЖЕНИЯ ОПЛАТЫ: определяются дополнительно.

На суммы, выплаченные с опозданием по отношению к оговоренной дате платежа, начисляются проценты по установленной законом ставке. Любые кредитные ноты будут вычитаться из следующего счета-фактуры.

ЦЕНЫ: цены не являются обязательными, они могут изменяться без предварительного уведомления, в этом случае они будут подтверждены в заказе. Все цены указаны без учета НДС.

УСЛОВИЯ ДОСТАВКИ: 1. Для Италии возможна отгрузка в течение 24 часов для станков, имеющихся на складе. 2. для машин, которые должны быть произведены, пожалуйста, приготовьте примерно 25 дней, за исключением непредвиденных обстоятельств.

ТРАНСПОРТИРОВКА: БЕСПЛАТНАЯ ДОСТАВКА, товар перевозится на риск покупателя, поэтому Fimar S.p.a. не несет ответственности за любой ущерб, нанесенный товару во время транспортировки. Любые претензии должны быть предъявлены в момент доставки в рамках установленных законом сроков.

ТЕХНИЧЕСКОЕ ОБСЛУЖИВАНИЕ: оплачивается дилером в течение всего срока действия гарантии, составляющего один год. Fimar S.p.a. обязуется поставлять по гарантии все запасные части, признанные дефектными. В цену продажи, выставленную конечному пользователю, включается не только стоимость проданных готовых изделий, но и расходы дилера на гарантийное обслуживание этих изделий. Компания Fimar S.p.a. не несет никаких прямых или косвенных расходов, понесенных торговым представителем в связи с управлением гарантией. Гарантия теряет силу, если изделие повреждено или вышло из строя в результате неправильного или иного несоответствующего использования.

УСТАНОВКА: за установку и инструктаж по эксплуатации машины и ее принадлежностей отвечает дилер.

РЕМОНТ: в случае неприятия сметы на ремонт взимается 25,00 евро в качестве взноса на эксплуатационные расходы.

ГАРАНТИЯ: 12 месяцев.

ВОЗВРАТ: за любой разрешенный возврат товара с неповрежденной упаковкой удерживается сбор в размере 15% от стоимости, минимальная сумма составляет € 50.

СТРАХОВАНИЕ: все наши машины застрахованы (ответственность перед третьими лицами), за исключением США и Канады.

КАТАЛОГ/ПЕРЕЧЕНЬ: данный документ отменяет все предыдущие. Технические данные, иллюстрации и фотографии, приведенные в данном документе, являются исключительно ориентировочными. Компания оставляет за собой право изменять технические и эстетические характеристики или прекращать его производство в любое время без предварительного уведомления.

ИЗОБРАЖЕНИЯ И ИЛЛУСТРАЦИИ: Все изображения, сделанные производителем, защищены авторским правом. Их использование или воспроизведение осуществляется с разрешения компании-владельца товарного знака и прав на материалы и интеллектуальную собственность. Цены или технические данные могут быть изменены в случае опечаток или изменений.

ТОРГОВЫЕ ЗНАКИ И ПАТЕНТЫ: Категорически запрещается использовать торговые марки и/или патенты, зарегистрированные компанией Fimar S.p.a. Обратите внимание, что все машины и принадлежности, не имеющие маркировки CE, обладают специфическими характеристиками, которые делают их непригодными для продажи на территории стран Европейского Союза.

ЗАПРОС ДОПОЛНИТЕЛЬНОЙ ТЕХНИЧЕСКОЙ ДОКУМЕНТАЦИИ: Копия, соответствующая оригиналу сертификата CE: € 20,00 + стоимость доставки - Твердая копия руководства по эксплуатации и техническому обслуживанию: € 40,00 + стоимость доставки.

MOD165V02 - ГОТОВО К ПЕЧАТИ В СЕНТЯБРЕ 2025



IT

Primo macchinario progettato e realizzato da Fimar nel 1979, è il Tritacarne che oggi troviamo in diverse dimensioni, abbinato con la grattugia o nella sua ultima versione anche refrigerato.

I macchinari sono tutti Made in Italy studiati per le esigenze di ristoranti, macellerie non industriali e supermercati.

Completano la categoria lavorazione della carne: Grattugie, Segaoossi Anodizzati o Verniciati, Impastatrici per Carne, Insaccatrici Manuali e Pressamburger.

EN

The first machine designed and manufactured by Fimar in 1979, was the Meat Mincer today presented in different sizes, combined with a grater or in its latest version: refrigerated.

All of our machines are Made in Italy and have been designed to satisfy restaurants, non-industrial butchers and supermarkets needs.

The meat processing category is completed by: Graters, Anodized or Painted Bone Bandsaw, Meat Mixers, Manual Sausage Fillers and Hamburger Presses.

FR

La première machine conçue et fabriquée par Fimar en 1979, a été le hachoir à viande aujourd'hui présenté en différentes tailles, combiné avec une râpe ou dans la dernière version réfrigérée.

Toutes nos machines sont fabriquées en Italie et ont été conçues pour satisfaire les besoins des restaurants, des boucheries artisanales et des supermarchés.

La catégorie "transformation de la viande" est complétée par: Râpes, Scie à os Anodisée ou Peinte, Mélangeurs de viande, Pousseurs Manuels à saucisses et Presses à hamburger.

DE

Das erste Gerät, das im Jahr 1979 von Fimar entwickelt und hergestellt wurde, ist der Fleischwolf, heute verfügbar in verschiedenen Größen, kombiniert mit Reibe oder in seiner neuesten Version: gekühlt.

Alle unsere Maschinen sind „Made in Italy“ und wurden entwickelt, um die Bedürfnisse von Restaurants, kleinen Metzgereien und Supermärkten zu erfüllen.

Die Kategorie der Fleischverarbeitung ist durch Reiben, eloxierte oder lackierte Knochenbandsäge, Fleischmischer, manuelle Wurstfüllmaschinen und Hamburgerpressen ergänzt.

ES

La primera máquina diseñada y fabricada por Fimar en 1979, fue la Picadora de Carne que hoy se presenta en diferentes tamaños, combinada con un rallador o en la última versión refrigerada.

Todas nuestras máquinas son Made in Italy y han sido diseñadas para satisfacer las necesidades de restaurantes, carnicerías artesanales y supermercados.

La categoría de procesamiento de carne se completa con: Ralladoras, Sierra de cinta para huesos anodizada o pintada, Mezcladoras de carne, llenadoras manuales de salchichas y Presas para hamburguesas.

RU

Первой машиной, разработанной и изготовленной Fimar в 1979 году, стала мясорубка, представленная сегодня в различных размерах, в сочетании с теркой или в последней версии: холодильной.

Все наши машины сделаны в Италии и разработаны для удовлетворения потребностей ресторанов, непромышленных мясников и супермаркетов.

Категория мясopереработки завершается: Терка, Анодированная или окрашенная костная ленточная пила, Мешалки для мяса, Ручные дозаторы колбасы и Гамбургерные Прессы.

32REFI
22REFI



80 mm

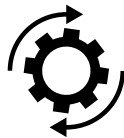

Inversione di marcia
Reverse function
Реверс



52 mm



32REFI















22REFI

Tritacarne
refrigerati

REFRIGERATED MEAT MINCER
HACHOIR À VIANDE RÉFRIGÉRÉ
GEKÜHLTER FLEISHWOLF
PICADORA DE CARNE REFRIGERADA
ОХЛАЖДАЕМАЯ МЯСОРУБКА

- IT** Ideale per laboratori di macelleria di medie dimensioni, supermercati e per la ristorazione. Refrigerazione della tramoggia, del collo di alimentazione e del gruppo di macinazione - bocca ingresso carne 22REFI ø 52 mm - bocca ingresso carne 32REFI ø 80 mm - temperatura di lavoro +4° - tramoggia fissa - grande versatilità in dimensioni compatte - gruppo di macinazione e struttura in acciaio inox AISI 304 - comandi frontali - bloccaggio gruppo di macinazione laterale - inversione di marcia.
- EN** Perfect for medium-sized butcher's shops, supermarkets and restaurants. Refrigerated hopper, feeding neck and grinding unit - meat inlet 22REFI ø 52 mm - meat inlet 32REFI ø 80 mm - operating temperature +4° - static hopper - great versatility in compact dimensions - grinding unit and casing in stainless steel AISI 304 - frontal controls - grinding unit side locking - reverse function.
- FR** Parfait pour les boucheries, supermarchés et restaurants de taille moyenne. Trémie, orifice d'alimentation et groupe de hachage réfrigérée - orifice d'entrée viande 22REFI ø 52 mm - orifice d'entrée viande 32REFI ø 80 mm - température de service +4° - trémie fixe - flexibilité élevée dans des dimensions compactes - groupe de hachage et corps en acier inox AISI 304 - commandes frontales - verrouillage du groupe de hachage latéral - inversion de marche.
- DE** Die ideale Lösung für mittelgroße Metzgereien, Supermärkte und Restaurants. Trichter, Fleischeführöffnung und Zerkleinerungseinheit gekühlt - Fleischeführöffnung 22REFI ø 52 mm - Fleischeführöffnung 32REFI ø 80 mm - Betriebstemperatur +4° - stationärer Trichter - große Vielseitigkeit bei kompakten Maßen - Gehäuse und Zerkleinerungseinheit aus Edelstahl AISI 304 - frontseitige Bedienelemente - seitliche Verriegelung der Zerkleinerungseinheit - Umkehrgetriebe.
- ES** Ideal para carnicerías, supermercados y restaurantes de tamaño medio. Tolva, cuello de alimentación y grupo de picar refrigerado - boca para introducir la carne 22REFI de ø 52 mm - boca para introducir la carne 32REFI de ø 80 mm - temperatura de trabajo +4° - tolva fija - gran versatilidad en dimensiones compactas - grupo de picar y carcasa de acero inoxidable AISI 304 - controles frontales - bloqueo lateral de la unidad de picar - inversión de marcha.
- RU** Идеальное решение для средних мясных магазинов, супермаркетов и ресторанов. Охлаждаемые воронка, мясоприемник и узел измельчения - мясоприемник 22REFI с горловиной ø 52 мм - мясоприемник 32REFI с горловиной ø 80 мм - рабочая температура +4° - стационарная воронка - высокая гибкость в эксплуатации и компактные размеры - корпус и узел измельчения из нержавеющей стали AISI 304 - панель управления на лицевой стороне - боковая фиксация узла измельчения - Реверс.

	32REFI	22REFI
	1,87 kW (2,54 HP)	1,1 kW (1,5 HP)
	230-400V/3N/50-60Hz	230-400V/3N/50Hz
	-	230V/1N/50-60Hz
	300÷500 Kg/h	150÷250 Kg/h
	R1234yf	
	350 x 530 x 555(h) mm	270 x 410 x 545(h) mm
		
	56 Kg	43 Kg
	61 Kg	48 Kg
	760 x 600 x 770(h) mm	
	0,351 m³	

Inox Unger System - Инокс Система Unger

Special Voltages - Разное питающее напряжение



32TN-32TND
32TNE



32TN - 32TND



76 mm



Inversione di marcia
Reverse function
Реверс

Tritacarne

MEAT MINCER
HACHOIR À VIANDE
FLEISCHWOLF
PICADORE DE CARNE
МЯСОРУБКА

IT Carcassa e tramoggia in acciaio inox. Macchina con gruppo di macinazione completamente removibile che permette di poterlo collocare in frigorifero - il gruppo di macinazione in acciaio inox AISI 304 può essere lavato in lavastoviglie - ventola di raffreddamento - bocca ingresso carne \varnothing 76 mm - microinterruttori di sicurezza su tramoggia - inversione di marcia (mod. 32TN - 32TND) - riduttore con ingranaggi a bagno d'olio - in dotazione sistema enterprise con piastra inox (fori \varnothing 6 mm) e coltello inox autoaffilante.

FR Corps et trémie en acier inox. Machine avec groupe de hachage entièrement amovible qui permet de pouvoir le placer dans le réfrigérateur - l'unité de broyage en acier inox AISI 304 peut être lavée au lave-vaisselle - ventilateur de refroidissement - orifice d'entrée viande \varnothing 76 mm - inversion de marche (mod. 32TN - 32TND) - micro-interrupteurs de sécurité sur la trémie - motomoteur réducteur à engrenages à bain d'huile. De série, système enterprise avec plaque en inox (trous \varnothing 6 mm) et couteau inox aiguisement automatique.

ES Carcasa y tolva de acero inoxidable. Máquina con grupo de picar completamente extraíble que permite poderlo colocar en la nevera. El grupo de picar de acero inoxidable AISI 304 puede ser limpiado en el lavavajillas - ventilador de enfriamiento - boca de \varnothing 76 mm para introducir la carne - microinterruptores de seguridad en la tolva - inversión de marcha (mod. 32TN - 32TND) - reductor con engranajes en baño de aceite - en dotación sistema enterprise con placa de acero inoxidable (agujeros \varnothing 6 mm) y cuchilla de acero inoxidable con autoafilado.

EN Stainless steel casing and hopper. Machine with a completely removable grinding unit that allows it to be placed in the refrigerator - hygiene standards - the grinding unit in stainless steel AISI 304 can be washed in the dishwasher - cooling fan - meat inlet \varnothing 76 mm - safety microswitches on the hopper - reverse function (mod. 32TN - 32TND) - oiled gear motor - equipped with enterprise system with stainless steel plate (holes \varnothing 6 mm) and self-sharpening stainless steel knife.



















DE Gehäuse und Trichter aus Edelstahl. Maschine mit Zerkleinerungseinheit, die vollständig abnehmbar ist und daher die Aufbewahrung im Kühlschrank gestattet. Hygienevorschriften von den Hackfleischrückständen gereinigt zu werden, die Zerkleinerungseinheit aus Edelstahl AISI 304 kann in der Geschirrspülmaschine gereinigt werden. Kühllüfter - Fleischinlassöffnung \varnothing 76 mm - Sicherheitsmikroschalter am Trichter - Umkehrgetriebe (mod. 32TN - 32TND) - Getriebemotor mit Ölbad - ausgestattet mit Enterprise System mit Edelstahlplatte (Löcher \varnothing 6 mm) und selbstschärfendem Edelmessers.

RU Корпус и воронка из нержавеющей стали. Машина с полностью съемным измельчающим устройством, которое может храниться в холодильнике без предварительной очистки от мясного фарша после каждого использования в соответствии с гигиеническими нормами HACCP, узел измельчения из нержавеющей стали AISI 304 можно мыть в посудомоечной машине. Охлаждающий вентилятор - Мясоприемник \varnothing 76 мм - Предохранительный микровыключатель на воронке - Реверс (mod. 32TN - 32TND) - Привод с масляной ванной - Система Enterprise с решеткой из нержавеющей стали (отверстия \varnothing 6 мм) и самозатачивающимся ножом из нержавеющей стали.

















76 mm

32TNE

	32TN		32TND	
	2,2 kW (3 HP)		1,6 kW (2,2 HP)	
	230-400V/3N/50Hz			
	230V/1N/50Hz			
	300÷500 Kg/h			
	520 x 320 x 550(h) mm			
				
	 53 Kg	 43 Kg	 41 Kg	 39 Kg
	 59 Kg	 49 Kg	 46 Kg	 44 Kg
	570 x 420 x 680(h) mm			
	0,163 m³			
	Gruppo di macinazione in alluminio Aluminium grinding unit Groupe de hachage en aluminium Zerkleinerungseinheit aus Aluminium Grupo de picar de aluminio Режущая группа из алюминий	Gruppo macinazione inox Stainless steel mincing unit Groupe de hachage en inox Zerkleinerungseinheit aus Edelstahl Grupo para picar de acero inoxidable Узел измельчения из нержавеющей стали	Gruppo di macinazione in alluminio Aluminium grinding unit Groupe de hachage en aluminium Zerkleinerungseinheit aus Aluminium Grupo de picar de aluminio Режущая группа из алюминий	Gruppo macinazione inox Stainless steel mincing unit Groupe de hachage en inox Zerkleinerungseinheit aus Edelstahl Grupo para picar de acero inoxidable Узел измельчения из нержавеющей стали

Inox Unger System - Инок Система Unger

Special Voltages - Разное питающее напряжение

	32TNE	
	1,6 kW (2,2 HP)	
	230-400V/3N/50Hz	
	230V/1N/50Hz	
	300÷500 Kg/h	
	520 x 320 x 550(h) mm	
		
	 41 Kg	 39 Kg
	 46 Kg	 44 Kg
	570 x 420 x 680(h) mm	
	0,163 m³	
	<p>Gruppo di macinazione in alluminio Aluminium grinding unit Groupe de hachage en aluminium Zerkleinerungseinheit aus Aluminium Grupo de picar de aluminio Режущая группа из алюминий</p>	<p>Gruppo macinazione inox Stainless steel mincing unit Groupe de hachage en inox Zerkleinerungseinheit aus Edelstahl Grupo para picar de acero inoxidable Узел измельчения из нержавеющей стали</p>

Inox Unger System - Инокс Система Unger

Special Voltages - Разное питающее напряжение



32TN - 32TND - 32TNE

OPTIONAL



32RS-32RSD
32RSE



76 mm



Inversione di marcia
Reverse function
Реверс

Tritacarne

MEAT MINCER
HACHOIR À VIANDE
FLEISCHWOLF
PICADORE DE CARNE
МЯСОРУБКА

IT Carcassa e tramoggia in acciaio inox. Gruppo macinazione estraibile in acciaio inox AISI 304 - ventola di raffreddamento - riduttore con ingranaggi a bagno d'olio. In dotazione sistema enterprise con piastra inox (fori \varnothing 6 mm) e coltello inox autoaffilante.

32RS-32RSD: bocca ingresso carne \varnothing 76 mm - microinterruttori di sicurezza su tramoggia - inversione di marcia.

32RSE: bocca ingresso carne \varnothing 52 mm.

FR Corps et trémie en acier inox - groupe de hachage amovible en acier inox AISI 304 - ventilateur de refroidissement - motoréducteur à engrenages à bain d'huile - de série, système enterprise avec plaque en inox (trous \varnothing 6 mm) et couteau inox aiguisement automatique.

32RS-32RSD: orifice d'entrée viande \varnothing 76 mm - micro-interrupteurs de sécurité sur la trémie - inversion de marche.

32RSE: orifice d'entrée viande \varnothing 52 mm.

ES Carcasa y tolva de acero inoxidable - grupo para picar de acero inoxidable AISI 304 extraíble - ventilador de refrigeración - reductor con engranajes en baño de aceite. En la dotación sistema enterprise con placa de acero inoxidable (agujeros \varnothing 6 mm) y cuchilla de acero inoxidable con autoafilado.

32RS-32RSD: boca de \varnothing 76 mm para introducir la carne - microinterruptores de seguridad en la tolva - inversión de marcha.

32RSE: boca de \varnothing 52 mm para introducir la carne.

EN Stainless steel casing and hopper. Removable grinding unit in stainless steel AISI 304 - cooling fan - oiled gear motor. Equipped with enterprise system with stainless steel plate (holes \varnothing 6 mm) and self-sharpening stainless steel knife.

32RS-32RSD: meat inlet \varnothing 76 mm - safety microswitches on the hopper - reverse function.

32RSE: meat inlet \varnothing 52 mm.

DE Gehäuse und Trichter aus Edelstahl - herausnehmbare Schneidegruppe aus Edelstahl AISI 304 - Kühllüfter - Getriebemotor mit Ölbad - ausgestattet mit Enterprise-System mit Edelstahlplatte (Löcher \varnothing 6 mm) und selbstschärfendem Edelstahlmesser.

32RS-32RSD: Fleischeinführöffnung \varnothing 76 mm - Sicherheitsmikroschalter am Trichter - Umkehrgetriebe.

32RSE: Fleischeinlassöffnung \varnothing 52 mm.



















RU Корпус и воронка из нержавеющей стали - Съёмная режущая группа из нержавеющей стали AISI 304 - Охлаждающий вентилятор - Привод с масляной ванной - Система Enterprise с решеткой из нержавеющей стали (отверстия \varnothing 6 мм) и самозатачивающимся ножом из нержавеющей стали.

32RS-32RSD: Мясоприемник \varnothing 76 мм - Предохранительный микровыключатель на воронке - Реверс.

32RSE: Мясоприемник \varnothing 52 мм.

















52 mm

		32RS		32RSD				
		2,2 kW (3 HP)		1,6 kW (2,2 HP)				
		230-400V/3N/50Hz						
		230V/1N/50Hz						
		300÷500 Kg/h						
		490 x 340 x 530(h) mm						
								
		53 Kg		43 Kg		41 Kg		39 Kg
		59 Kg		49 Kg		46 Kg		44 Kg
		570 x 420 x 680(h) mm						
		0,163 m³						
		Gruppo di macinazione in alluminio Aluminium grinding unit Groupe de hachage en aluminium Zerkleinerungseinheit aus Aluminium Grupo de picar de aluminio Режущая группа из алюминий	Gruppo macinazione inox Stainless steel mincing unit Groupe de hachage en inox Zerkleinerungseinheit aus Edelstahl Grupo para picar de acero inoxidable Узел измельчения из нержавеющей стали	Gruppo di macinazione in alluminio Aluminium grinding unit Groupe de hachage en aluminium Zerkleinerungseinheit aus Aluminium Grupo de picar de aluminio Режущая группа из алюминий	Gruppo macinazione inox Stainless steel mincing unit Groupe de hachage en inox Zerkleinerungseinheit aus Edelstahl Grupo para picar de acero inoxidable Узел измельчения из нержавеющей стали			

Inox Unger System - Инок Система Unger

Special Voltages - Разное питающее напряжение

	32RSE	
	1,6 kW (2,2 HP)	
	230-400V/3N/50Hz	
	230V/1N/50Hz	
	250÷350 Kg/h	
	490 x 340 x 530(h) mm	
		
	 41 Kg	 38 Kg
	 46 Kg	 43 Kg
	570 x 420 x 680(h) mm	
	0,163 m³	
	<p>Gruppo di macinazione in alluminio Aluminium grinding unit Groupe de hachage en aluminium Zerkleinerungseinheit aus Aluminium Grupo de picar de aluminio Режущая группа из алюминий</p>	<p>Gruppo macinazione inox Stainless steel mincing unit Groupe de hachage en inox Zerkleinerungseinheit aus Edelstahl Grupo para picar de acero inoxidable Узел измельчения из нержавеющей стали</p>

Inox Unger System - Иннокс Система Unger

Special Voltages - Разное питающее напряжение



32RS - 32RSD

OPTIONAL



22RG
22RGE



64 mm

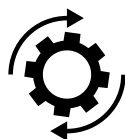

Inversione di marcia
Reverse function
Реверс



64 mm



22RG



22RGE

Tritacarne

MEAT MINCER
HACHOIR À VIANDE
FLEISCHWOLF
PICADORE DE CARNE
МЯСОРУБКА

IT Carcassa e tramoggia in acciaio inox. Gruppo macinazione estraibile in acciaio inox AISI 304 - bocca ingresso carne ø 64 mm - microinterruttori di sicurezza su tramoggia - inversione di marcia (mod. 22RG) - riduttore con ingranaggi a bagno d'olio. In dotazione sistema enterprise con piastra inox (fori ø 6 mm) e coltello inox autoaffilante.











FR Corps et trémie en acier inox - groupe de hachage amovible en acier inox AISI 304 - orifice d'entrée viande ø 64 mm - micro-interrupteurs de sécurité sur la trémie - inversion de marche (mod. 22RG) - motoréducteur à engrenages à bain d'huile. De série, système enterprise avec plaque en inox (trous ø 6 mm) et couteau inox autoaffilant.

ES Carcasa y tolva de acero inoxidable - grupo para picar de acero inoxidable (AISI 304) extraible - boca de ø 64 mm para introducir la carne - microinterruptores de seguridad en la tolva - inversión de marcha (mod. 22RG) - reductor con engranajes en baño de aceite. En la dotación sistema enterprise con placa de acero inoxidable (agujeros ø 6 mm) y cuchilla de acero inoxidable con autoafilado.

EN Stainless steel casing and hopper. Removable grinding unit in stainless steel AISI 304 - meat inlet ø 64 mm - safety microswitches on the hopper - reverse function (mod. 22RG) - oiled gear motor. Equipped with enterprise system with stainless steel plate (holes ø 6 mm) and self-sharpening stainless steel knife.

DE Gehäuse und Trichter aus Edelstahl - herausnehmbare Schneidegruppe aus Edelstahl AISI 304 - Fleischeinführöffnung ø 64 mm - Sicherheitsmikroschalter am Trichter - Umkehrgetriebe (mod. 22RG) - Getriebemotor mit Ölbad - ausgestattet mit Enterprise-System mit Edelstahlplatte (Löcher 6 mm) und selbstschärfendem Edelmessers.

RU Корпус и воронка из нержавеющей стали - Съёмная режущая группа из нержавеющей стали AISI 304 - Мясоприемник ø 64 mm - Предохранительный микровыключатель на воронке - Реверс (mod. 22RG) - Привод с масляной ванной - Система Enterprise с решеткой из нержавеющей стали (отверстия ø 6 мм) и самозатачивающимся ножом из нержавеющей стали.

	22RG		22RGE	
				
	1,1 kW (1,5 HP)			
	230-400V/3/50Hz		230-400V/3N/50Hz	
	230V/1N/50Hz			
	200÷300 Kg/h			
	410 x 310 x 490(h) mm			
				
	32 Kg			
	38 Kg			
	570 x 420 x 680(h) mm			
	0,163 m³			
	Gruppo di macinazione in alluminio	Gruppo macinazione inox	Gruppo di macinazione in alluminio	Gruppo macinazione inox
	Aluminium grinding unit	Stainless steel mincing unit	Aluminium grinding unit	Stainless steel mincing unit
	Groupe de hachage en aluminium	Groupe de hachage en inox	Groupe de hachage en aluminium	Groupe de hachage en inox
	Zerkleinerungseinheit aus Aluminium	Zerkleinerungseinheit aus Edelstahl	Zerkleinerungseinheit aus Aluminium	Zerkleinerungseinheit aus Edelstahl
	Grupo de picar de aluminio	Grupo para picar de acero inoxidable	Grupo de picar de aluminio	Grupo para picar de acero inoxidable
	Режущая группа из алюминий	Узел измельчения из нержавеющей стали	Режущая группа из алюминий	Узел измельчения из нержавеющей стали



GUARDA IL VIDEO
WATCH THE VIDEO

Inox Unger System - Инокс Система Unger

Special Voltages - Разное питающее напряжение

OPTIONAL



69

33

22RS 22RSE



52 mm

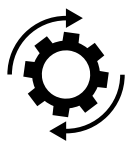

Inversione di marcia
Reverse function
Реверс



52 mm



22RS













22RSE

Tritacarne

MEAT MINCER
HACHOIR À VIANDE
FLEISCHWOLF
PICADORE DE CARNE
МЯСОРУБКА

- IT** Carcassa e tramoggia in acciaio inox. Gruppo macinazione estraibile in acciaio inox AISI 304 - bocca ingresso carne \varnothing 52 mm - inversione di marcia (mod. 22RS) - riduttore con ingranaggi a bagno d'olio. In dotazione sistema enterprise con piastra inox (fori \varnothing 6 mm) e coltello inox autoaffilante.
- EN** Stainless steel casing and hopper. Removable grinding unit in stainless steel AISI 304 - meat inlet \varnothing 52 mm - reverse function (mod. 22RS) - oiled gear motor. Equipped with enterprise system with stainless steel plate (holes \varnothing 6 mm) and self-sharpening stainless steel knife.
- FR** Corps et trémie en acier inox - groupe de hachage amovible en acier inox AISI 304 - orifice d'entrée viande \varnothing 52 mm - inversion de marche (mod. 22RS) - motoréducteur à engrenages à bain d'huile. De série système enterprice avec plaque en inox (trous \varnothing 6 mm) et couteau inox aiguisement automatique.
- DE** Gehäuse und Trichter aus Edelstahl - herausnehmbare Schneidegruppe aus Edelstahl AISI 304 - Fleischeinführöffnung \varnothing 52 mm - Umkehrgetriebe (mod. 22RS) - Getriebemotor mit Ölbad - ausgestattet mit Enterprise-System mit Edelstahlplatte (Löcher 6 mm) und selbstschärfendem Edelmessers.
- ES** Carcasa y tolva de acero inoxidable - grupo para picar de acero inoxidable AISI 304 extraíble - boca de \varnothing 52 mm para introducir la carne - inversión de marcha (mod. 22RS) - reductor con engranajes en baño de aceite. En la dotación sistema enterprise con placa de acero inoxidable (agujeros \varnothing 6 mm) y cuchilla de acero inoxidable con autoafilado.
- RU** Корпус и воронка из нержавеющей стали - Съёмная режущая группа из нержавеющей стали AISI 304 - Мясоприемник \varnothing 52 мм - Реверс (mod. 22RS) - Привод с масляной ванной - Система Enterprise с решеткой из нержавеющей стали (отверстия \varnothing 6 мм) и самозатачивающимся ножом из нержавеющей стали.

	22RS		22RSE	
				
	1,1 kW (1,5 HP)			
	230-400V/3/50Hz		230-400V/3N/50Hz	
	230V/1N/50Hz			
	150÷250 Kg/h			
	410 x 310 x 520(h) mm			
				
	32 Kg			
	38 Kg			
	570 x 420 x 680(h) mm			
	0,163 m³			
	Gruppo di macinazione in alluminio Aluminium grinding unit Groupe de hachage en aluminium Zerkleinerungseinheit aus Aluminium Grupo de picar de aluminio Режущая группа из алюминий	Gruppo macinazione inox Stainless steel mincing unit Groupe de hachage en inox Zerkleinerungseinheit aus Edelstahl Grupo para picar de acero inoxidable Узел измельчения из нержавеющей стали	Gruppo di macinazione in alluminio Aluminium grinding unit Groupe de hachage en aluminium Zerkleinerungseinheit aus Aluminium Grupo de picar de aluminio Режущая группа из алюминий	Gruppo macinazione inox Stainless steel mincing unit Groupe de hachage en inox Zerkleinerungseinheit aus Edelstahl Grupo para picar de acero inoxidable Узел измельчения из нержавеющей стали

Inox Unger System - Инок Система Unger

Special Voltages - Разное питающее напряжение

OPTIONAL



69

35

22TS
22TSE



52 mm

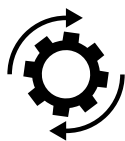

Inversione di marcia
Reverse function
Реверс



52 mm



22TS



22TSE



Tritacarne

MEAT MINCER
HACHOIR À VIANDE
FLEISCHWOLF
PICADORE DE CARNE
МЯСОРУБКА

IT Carcassa e tramoggia in acciaio inox. Macchina con gruppo di macinazione completamente removibile, che permette di poterlo collocare in frigorifero - il gruppo di macinazione in acciaio inox AISI 304 può essere lavato in lavastoviglie - bocca ingresso carne ø 52 mm - inversione di marcia (mod. 22TS) - riduttore con ingranaggi a bagno d'olio. In dotazione sistema enterprise con piastra inox (fori ø 6 mm) e coltello inox autoaffilante.











EN Stainless steel casing and hopper. Machine with a completely removable grinding unit that allows it to be placed in the refrigerator - the grinding unit in stainless steel AISI 304 can be washed in the dishwasher - meat inlet ø 52 mm - reverse function (mod. 22TS) - oiled gear motor. Equipped with enterprise system with stainless steel plate (holes ø 6 mm) and self-sharpening stainless steel knife.

FR Corps et trémie en acier inox. Machine avec groupe de hachage entièrement amovible qui permet de pouvoir le placer dans le réfrigérateur - l'unité de hachage en acier inox AISI 304 peut être lavée au lave-vaisselle - orifice d'entrée viande ø 52 mm - inversion de marche (mod. 22TS) - motoréducteur à engrenages à bain d'huile. De série, système enterprise avec plaque en inox (trous ø 6 mm) et couteau inox aiguisement automatique.

DE Gehäuse und Trichter aus Edelstahl - Maschine mit Zerkleinerungseinheit, die vollständig abnehmbar ist und daher die Aufbewahrung im Kühlschrank gestattet ohne vorher nach jeder Verwendung in Übereinstimmung mit den HACCP Hygienevorschriften von den Hackfleischrückständen gereinigt zu werden, die Zerkleinerungseinheit aus Edelstahl AISI 304 kann in der Geschirrspülmaschine gereinigt werden. Fleischeinlassöffnung ø 52 mm - Umkehrgetriebe (mod. 22TS) - Getriebemotor mit Ölbad - ausgestattet mit Enterprise-System mit Edelstahlplatte (Löcher ø 6 mm) und selbstschärfendem Edelstahlmesser.

ES Carcasa y tolva de acero inoxidable - Máquina con grupo de picar completamente extraíble que permite poderlo colocar en la nevera sin que tenga que ser limpiado de los restos de carne picada después de cada utilización - el grupo de picar de acero inoxidable AISI 304 puede ser limpiado en el lavavajillas - boca de ø 52 mm para introducir la carne - inversión de marcha (mod. 22TS) - reductor con engranajes en baño de aceite. En la dotación sistema enterprise con placa de acero inoxidable (agujeros ø 6 mm) y cuchilla de acero inoxidable con autoafilado.

RU Корпус и воронка из нержавеющей стали - Машина с полностью съемным измельчающим устройством, которое может храниться в холодильнике без предварительной очистки от мясного фарша после каждого использования в соответствии с гигиеническими нормами HACCP, узел измельчения из нержавеющей стали AISI 304 можно мыть в посудомоечной машине. Мясоприемник ø 52 мм - Реверс (mod. 22TS) - Привод с масляной ванной - Низковольтное управление - Система Enterprise с решеткой из нержавеющей стали (отверстия ø 6 мм) и самозатачивающимся ножом из нержавеющей стали.

	22TS		22TSE	
				
	1,1 kW (1,5 HP)			
	230-400V/3/50Hz		230-400V/3N/50Hz	
	230V/1N/50Hz			
	150÷250 Kg/h			
	420 x 300 x 520(h) mm			
				
	31 Kg			
	40 Kg			
	570 x 420 x 680(h) mm			
	0,163 m³			
	Gruppo di macinazione in alluminio Aluminium grinding unit Groupe de hachage en aluminium Zerkleinerungseinheit aus Aluminium Grupo de picar de aluminio Режущая группа из алюминий	Gruppo macinazione inox Stainless steel mincing unit Groupe de hachage en inox Zerkleinerungseinheit aus Edelstahl Grupo para picar de acero inoxidable Узел измельчения из нержавеющей стали	Gruppo di macinazione in alluminio Aluminium grinding unit Groupe de hachage en aluminium Zerkleinerungseinheit aus Aluminium Grupo de picar de aluminio Режущая группа из алюминий	Gruppo macinazione inox Stainless steel mincing unit Groupe de hachage en inox Zerkleinerungseinheit aus Edelstahl Grupo para picar de acero inoxidable Узел измельчения из нержавеющей стали

Inox Unger System - Инок Система Unger

Special Voltages - Разное питающее напряжение

OPTIONAL



22SN













∅
52 mm

Tritacarne

MEAT MINCER
HACHOIR À VIANDE
FLEISCHWOLF
PICADORE DE CARNE
МЯСОРУБКА

- IT** Struttura in alluminio lucidato con tramoggia in acciaio inox. Gruppo macinazione estraibile in acciaio inox AISI 304 - bocca ingresso carne ø 52 mm - riduttore con ingranaggi a bagno d'olio. In dotazione sistema enterprise con piastra inox (fori ø 6 mm) e coltello inox autoaffilante.
- EN** Polished aluminium structure with stainless steel hopper - removable grinding unit in stainless steel AISI 304 - meat inlet ø 52 mm - oiled gear motor. Equipped with enterprise system with stainless steel plate (holes ø 6 mm) and self-sharpening stainless steel knife.
- FR** Corps en aluminium poli avec trémie en acier inox. Groupe de hachage amovible en acier inox AISI 304 - orifice d'entrée viande ø 52 mm - motoréducteur à engrenages à bain d'huile. De série, système enterprise avec plaque en inox (trous ø 6 mm) et couteau inox aiguisement automatique.
- DE** Poliertes Aluminiumgehäuse mit Edelstahltrichter. Ausziehbare Zerkleinerungseinheit aus Edelstahl AISI 304 - Fleischeinführöffnung ø 52 mm - Getriebemotor mit Ölbad - ausgestattet mit Enterprise-System mit Edelstahlplatte (Löcher ø 6 mm) und selbstschärfendem Edelmesser.
- ES** Estructura de aluminio pulido con tolva de acero inoxidable. Grupo para picar de acero inoxidable (AISI 304) extraíble - boca de ø 52 mm para introducir la carne - reductor con engranajes en baño de aceite. En la dotación sistema enterprise con placa de acero inoxidable (agujeros ø 6 mm) y cuchilla de acero inoxidable con autoafilado.
- RU** Корпус из полированного алюминия с воронкой из нержавеющей стали. Съёмная режущая группа из нержавеющей стали AISI 304 - Мясоприемник ø 52 мм - Привод с масляной ванной - Система Enterprise с решеткой из нержавеющей стали (отверстия ø 6 мм) и самозатачивающимся ножом из нержавеющей стали.

	22SN	
	1,1 kW (1,5 HP)	
	230-400V/3/50Hz	
	230V/1N/50Hz	
	150÷250 Kg/h	
	450 x 290 x 520(h) mm	
		
	23 Kg	
	25 Kg	
	540 x 300 x 480(h) mm	
	0,078 m³	
	<p>Gruppo di macinazione in alluminio</p> <p>Aluminium grinding unit</p> <p>Groupe de hachage en aluminium</p> <p>Zerkleinerungseinheit aus Aluminium</p> <p>Grupo de picar de aluminio</p> <p>Режущая группа из алюминий</p>	<p>Gruppo macinazione inox</p> <p>Stainless steel mincing unit</p> <p>Groupe de hachage en inox</p> <p>Zerkleinerungseinheit aus Edelstahl</p> <p>Grupo para picar de acero inoxidable</p> <p>Узел измельчения из нержавеющей стали</p>

Inversione di marcia - Reverse function - Реверс



Inox Unger System - Инокс Система Unger

Special Voltages - Разное питающее напряжение

OPTIONAL



69

39

22TE













∅
52 mm



Tritacarne

MEAT MINCER
HACHOIR À VIANDE
FLEISCHWOLF
PICADORE DE CARNE
МЯСОРУБКА

- IT** Struttura in alluminio lucidato con tramoggia in acciaio inox. Macchina con gruppo di macinazione completamente removibile che permette di poterlo collocare in frigorifero - il gruppo di macinazione in acciaio inox AISI 304 può essere lavato in lavastoviglie - bocca ingresso carne ø 52 mm - riduttore con ingranaggi a bagno d'olio - in dotazione sistema enterprise con piastra inox (fori ø 6 mm) e coltello inox autoaffilante.
- EN** Polished aluminium structure with stainless steel hopper - Machine with a completely removable grinding unit that allows it to be placed in the refrigerator - the grinding unit in stainless steel AISI 304 can be washed in the dishwasher - meat inlet ø 52 mm - oiled gear motor. Equipped with enterprise system with stainless steel plate (holes ø 6 mm) and self-sharpening stainless steel knife.
- FR** Corps en aluminium poli avec trémie en acier inox. Machine avec groupe de hachage entièrement amovible qui permet de pouvoir le placer dans le réfrigérateur - l'unité de hachage en acier inox AISI 304 peut être lavée au lave-vaisselle - orifice d'entrée viande ø 52 mm - motoréducteur à engrenages à bain d'huile. De série, système enterprise avec plaque en inox (trous ø 6 mm) et couteau inox autoaiguisement automatique.
- DE** Gehäuse aus poliertem Aluminium mit Trichter aus Edelstahl. Maschine mit Zerkleinerungseinheit, die vollständig abnehmbar ist und daher die Aufbewahrung im Kühlschrank gestattet - Hygienevorschriften von den Hackfleischrückständen gereinigt zu werden, die Zerkleinerungseinheit aus Edelstahl AISI 304 kann in der Geschirrspülmaschine gereinigt werden. Fleischeinlassöffnung ø 52 mm - Getriebemotor mit Ölbad - ausgestattet mit Enterprise-System mit Edelstahlplatte (Löcher ø 6 mm) und selbstschärfendem Edelstahlmesser.
- ES** Estructura de aluminio pulido con tolva de acero inoxidable. Máquina con grupo de picar completamente extraíble que permite poderlo colocar en la nevera. El grupo de picar de acero inoxidable AISI 304 puede ser limpiado en el lavavajillas - boca de ø 52 mm para introducir la carne - reductor con engranajes en baño de aceite - en la dotación sistema enterprise con placa de acero inoxidable (agujeros ø 6 mm) y cuchilla de acero inoxidable con autoafilado.
- RU** Корпус из полированного алюминия с воронкой из нержавеющей стали. Машина с полностью съемным измельчающим устройством, которое может храниться в холодильнике без предварительной очистки от мясного фарша после каждого использования в соответствии с гигиеническими нормами HACCP, узел измельчения из нержавеющей стали AISI 304 можно мыть в посудомоечной машине. Мясоприемник ø 52 мм - Привод с масляной ванной - Система Enterprise с решеткой из нержавеющей стали (отверстия ø 6 мм) и самозатачивающимся ножом из нержавеющей стали.

	22TE	
	1,1 kW (1,5 HP)	
	230-400V/3N/50Hz	
	230V/1N/50Hz	
	150÷250 Kg/h	
	450 x 290 x 520(h) mm	
		
	25 Kg	
	27 Kg	
	540 x 300 x 480(h) mm	
	0,078 m³	
	Gruppo di macinazione in alluminio Aluminium grinding unit Groupe de hachage en aluminium Zerkleinerungseinheit aus Aluminium Grupo de picar de aluminio Режущая группа из алюминий	Gruppo macinazione inox Stainless steel mincing unit Groupe de hachage en inox Zerkleinerungseinheit aus Edelstahl Grupo para picar de acero inoxidable Узел измельчения из нержавеющей стали

Inversione di marcia - Reverse function - Реверс



Inox Unger System - Инокс Система Unger

Special Voltages - Разное питающее напряжение

OPTIONAL



69

41

22CE















Ø
52 mm



Tritacarne

MEAT MINCER
HACHOIR À VIANDE
FLEISCHWOLF
PICADORE DE CARNE
МЯСОРУБКА

- IT** Carcassa e tramoggia in acciaio inox. Macchina con gruppo di macinazione completamente removibile, che permette di poterlo collocare in frigorifero - il gruppo di macinazione in acciaio inox AISI 304 può essere lavato in lavastoviglie - bocca ingresso carne ø 52 mm - riduttore con ingranaggi a bagno d'olio. In dotazione sistema enterprise con piastra inox (fori ø 6 mm) e coltello inox autoaffilante.
- EN** Stainless steel casing and hopper. Machine with a completely removable grinding unit that allows it to be placed in the refrigerator - hygiene standards - the grinding unit in stainless steel AISI 304 can be washed in the dishwasher - meat inlet ø 52 mm - oiled gear motor. Equipped with enterprise system with stainless steel plate (holes ø 6 mm) and self-sharpening stainless steel knife.
- FR** Corps et trémie en acier inox - Machine avec groupe de hachage entièrement amovible qui permet de pouvoir le placer dans le réfrigérateur. L'unité de broyage en acier inox AISI 304 peut être lavée au lave-vaisselle - orifice d'entrée viande ø 52 mm - motoréducteur à engrenages à bain d'huile. De série, système enterprise avec plaque en inox (trous ø 6 mm) et couteau inox aiguisement automatique.
- DE** Gehäuse und Trichter aus Edelstahl - Maschine mit Zerkleinerungseinheit, die vollständig abnehmbar ist und daher die Aufbewahrung im Kühlschrank gestattet - Hygienevorschriften von den Hackfleischrückständen gereinigt zu werden, die Zerkleinerungseinheit aus Edelstahl AISI 304 kann in der Geschirrspülmaschine gereinigt werden. Fleischeinlassöffnung ø 52 mm - a usgestattet mit Enterprise-System mit Edelstahlplatte (Löcher ø 6 mm) und selbstschärfendem Edelstahlmesser.
- ES** Carcasa y tolva de acero inoxidable - Máquina con grupo de picar completamente extraíble que permite poderlo colocar en la nevera. El grupo de picar de acero inoxidable AISI 304 puede ser limpiado en el lavavajillas - boca de ø 52 mm para introducir la carne - reductor con engranajes en baño de aceite. En la dotación sistema enterprise con placa de acero inoxidable (agujeros ø 6 mm) y cuchilla de acero inoxidable con autoafilado.
- RU** Корпус и воронка из нержавеющей стали - Машина с полностью съемным измельчающим устройством, которое может храниться в холодильнике без предварительной очистки от мясного фарша после каждого использования в соответствии с гигиеническими нормами HACCP, узел измельчения из нержавеющей стали AISI 304 можно мыть в посудомоечной машине. Низковольтное управление - Мясоприемник ø 52 мм - Система Enterprise с решеткой из нержавеющей стали (отверстия ø 6 мм) и самозатачивающимся ножом из нержавеющей стали.

	22CE	
	1,1 kW (1,5 HP)	
	230-400V/3N/50Hz	
	3 Ph	
	1 Ph	
	Kg/h	
	470 x 270 x 450(h) mm	
		
	26 Kg	
	28 Kg	
	540 x 300 x 480(h) mm	
	0,078 m ³	
	Gruppo di macinazione in alluminio Aluminium grinding unit Groupe de hachage en aluminium Zerkleinerungseinheit aus Aluminium Grupo de picar de aluminio Режущая группа из алюминий	Gruppo macinazione inox Stainless steel mincing unit Groupe de hachage en inox Zerkleinerungseinheit aus Edelstahl Grupo para picar de acero inoxidable Узел измельчения из нержавеющей стали

Inversione di marcia - Reverse function - Ревверс



Inox Unger System - Инокс Система Unger

Special Voltages - Разное питающее напряжение

OPTIONAL



69

43

12CE













Ø
52 mm



Tritacarne

MEAT MINCER
HACHOIR À VIANDE
FLEISCHWOLF
PICADORE DE CARNE
МЯСОРУБКА

- IT** Struttura e tramoggia in acciaio inox - Macchina con gruppo di macinazione completamente removibile che permette di poterlo collocare in frigorifero - il gruppo di macinazione in acciaio inox AISI 304 può essere lavato in lavastoviglie - bocca ingresso carne ø 52 mm - riduttore con ingranaggi a bagno d'olio - in dotazione sistema enterprise con piastra inox (fori ø 6 mm) e coltello inox autoaffilante.
- EN** Stainless steel casing and hopper. Machine with a completely removable grinding unit that allows it to be placed in the refrigerator - the grinding unit in stainless steel AISI 304 can be washed in the dishwasher - meat inlet ø 52 mm - oiled gear motor. Equipped with enterprise system with stainless steel plate (holes ø 6 mm) and self-sharpening stainless steel knife.
- FR** Corps et trémie en acier inox - Machine avec groupe de hachage entièrement amovible qui permet de pouvoir le placer dans le réfrigérateur. En alternative, lavé également soigneusement dans un lave-vaisselle (seulement la version en acier inox). Bouche de hachage ø 52 mm - moteur réducteur à engrenages à bain d'huile. De série, système enterprise avec plaque en inox (trous ø 6 mm) et couteau inox aiguisement automatique.
- DE** Gehäuse und Trichter aus Edelstahl - Maschine mit Zerkleinerungseinheit, die vollständig abnehmbar ist und daher die Aufbewahrung im Kühlschrank gestattet - Hygienevorschriften von den Hackfleischrückständen gereinigt zu werden, die Zerkleinerungseinheit aus Edelstahl AISI 304 kann in der Geschirrspülmaschine gereinigt werden. Fleischeinlassöffnung ø 52 mm - Umkehrgetriebe - Getriebemotor mit Ölbad - ausgestattet mit Enterprise-System mit Edelstahlplatte (Löcher ø 6 mm) und selbstschärfendem Edelstahlmesser.
- ES** Carcasa de aluminio pulido con tolva de acero inoxidable. Máquina con grupo de picar completamente extraíble que permite poderlo colocar en la nevera. El grupo de picar de acero inoxidable AISI 304 puede ser limpiado en el lavavajillas - boca para introducir la carne ø 52 mm - reductor con engranajes en baño de aceite - en dotación sistema enterprise con placa de acero inoxidable (agujeros ø 6 mm) y cuchilla de acero inoxidable con autoafilado.
- RU** Корпус и воронка из нержавеющей стали - Машина с полностью съемным измельчающим устройством, которое может храниться в холодильнике без предварительной очистки от мясного фарша после каждого использования в соответствии с гигиеническими нормами HACCP, узел измельчения из нержавеющей стали AISI 304 можно мыть в посудомоечной машине. Мясоприемник ø 52 мм - Реверс - Привод с масляной ванной - Система Enterprise с решеткой из нержавеющей стали (отверстия ø 6 мм) и самозатачивающимся ножом из нержавеющей стали.

	12CE	
	0,75 kW (1 HP)	
	230-400V/3N/50Hz	
	230V/1N/50Hz	
	100÷160 Kg/h	
	440 x 270 x 450(h) mm	
		
	22 Kg	
	24 Kg	
	540 x 300 x 480(h) mm	
	0,078 m³	
	Gruppo di macinazione in alluminio Aluminium grinding unit Groupe de hachage en aluminium Zerkleinerungseinheit aus Aluminium Grupo de picar de aluminio Режущая группа из алюминий	Gruppo macinazione inox Stainless steel mincing unit Groupe de hachage en inox Zerkleinerungseinheit aus Edelstahl Grupo para picar de acero inoxidable Узел измельчения из нержавеющей стали

Inversione di marcia - Reverse function - Реверс



Inox Unger System - Инокс Система Unger

Special Voltages - Разное питающее напряжение

OPTIONAL



69

45

12TS













Ø
52 mm



Tritacarne

MEAT MINCER
HACHOIR À VIANDE
FLEISCHWOLF
PICADORE DE CARNE
МЯСОРУБКА

- IT** Struttura in alluminio lucidato con tramoggia in acciaio inox. Macchina con gruppo di macinazione completamente removibile che permette di poterlo collocare in frigorifero - il gruppo di macinazione in acciaio inox AISI 304 può essere lavato in lavastoviglie - bocca ingresso carne ø 52 mm - riduttore con ingranaggi a bagno d'olio - in dotazione sistema enterprise con piastra inox (fori ø 6 mm) e coltello inox autoaffilante.
- EN** Polished aluminium structure with stainless steel hopper - Machine with a completely removable grinding unit that allows it to be placed in the refrigerator - the grinding unit in stainless steel AISI 304 can be washed in the dishwasher - meat inlet ø 52 mm - oiled gear motor. Equipped with enterprise system with stainless steel plate (holes ø 6 mm) and self-sharpening stainless steel knife.
- FR** Corps en aluminium poli avec trémie en acier inox. Machine avec groupe de hachage entièrement amovible qui permet de pouvoir le placer dans le réfrigérateur - l'unité de hachage en acier inox AISI 304 peut être lavée au lave-vaisselle - orifice d'entrée viande ø 52 mm - motoréducteur à engrenages à bain d'huile. De série, système enterprise avec plaque en inox (trous ø 6 mm) et couteau inox autoaffilant.
- DE** Gehäuse aus poliertem Aluminium mit Trichter aus Edelstahl. Maschine mit Zerkleinerungseinheit, die vollständig abnehmbar ist und daher die Aufbewahrung im Kühlschrank gestattet - Hygienevorschriften von den Hackfleischrückständen gereinigt zu werden, die Zerkleinerungseinheit aus Edelstahl AISI 304 kann in der Geschirrspülmaschine gereinigt werden. Fleischeinlassöffnung ø 52 mm - Getriebemotor mit Ölbad - ausgestattet mit Enterprise-System mit Edelstahlplatte (Löcher ø 6 mm) und selbstschärfendem Edelstahlmesser.
- ES** Carcasa de aluminio pulido con tolva de acero inoxidable. Máquina con grupo de picar completamente extraíble que permite poderlo colocar en la nevera. El grupo de picar de acero inoxidable AISI 304 puede ser limpiado en el lavavajillas - boca para introducir la carne ø 52 mm - reductor con engranajes en baño de aceite - en dotación sistema enterprise con placa de acero inoxidable (agujeros ø 6 mm) y cuchilla de acero inoxidable con autoafilado.
- RU** Корпус из полированного алюминия с воронкой из нержавеющей стали. Машина с полностью съемным измельчающим устройством, которое может храниться в холодильнике без предварительной очистки от мясного фарша после каждого использования в соответствии с гигиеническими нормами HACCP, узел измельчения из нержавеющей стали AISI 304 можно мыть в посудомоечной машине. Мясоприемник ø 52 мм - Привод с масляной ванной - Система Enterprise с решеткой из нержавеющей стали (отверстия ø 6 мм) и самозатачивающимся ножом из нержавеющей стали.

	12TS	
	0,75 kW (1 HP)	
	230-400V/3/50Hz	
	230V/1N/50Hz	
	100÷160 Kg/h	
	400 x 290 x 510(h) mm	
		
	20 Kg	
	22 Kg	
	540 x 300 x 480(h) mm	
	0,078 m³	
	Gruppo di macinazione in alluminio Aluminium grinding unit Groupe de hachage en aluminium Zerkleinerungseinheit aus Aluminium Grupo de picar de aluminio Режущая группа из алюминий	Gruppo macinazione inox Stainless steel mincing unit Groupe de hachage en inox Zerkleinerungseinheit aus Edelstahl Grupo para picar de acero inoxidable Узел измельчения из нержавеющей стали

Inversione di marcia - Reverse function - Реверс



Inox Unger System - Инокс Система Unger

Special Voltages - Разное питающее напряжение

OPTIONAL



69

47

12S



∅
52 mm

Tritacarne

MEAT MINCER
HACHOIR À VIANDE
FLEISCHWOLF
PICADORE DE CARNE
МЯСОРУБКА

- IT** Struttura in alluminio lucidato con tramoggia in acciaio inox. Gruppo macinazione estraibile in acciaio inox AISI 304 - bocca ingresso carne ø 52 mm - riduttore con ingranaggi a bagno d'olio - in dotazione sistema enterprise con piastra inox (fori ø 6 mm) e coltello inox autoaffilante.
- EN** Polished aluminium structure with stainless steel hopper - removable grinding unit in stainless steel AISI 304 - meat inlet ø 52 mm - oiled gear motor. Equipped with enterprise system with stainless steel plate (holes ø 6 mm) and self-sharpening stainless steel knife.
- FR** Corps en aluminium poli avec trémie en acier inox. Groupe de hachage amovible en acier inox AISI 304 - orifice d'entrée viande ø 52 mm - motoréducteur à engrenages à bain d'huile. De série, système enterprise avec plaque en inox (trous ø 6 mm) et couteau inox aiguisement automatique.
- DE** Poliertes Aluminiumgehäuse mit Edelstahltrichter. Ausziehbare Zerkleinerungseinheit aus Edelstahl AISI 304 - Fleischeinführöffnung ø 52 mm - Getriebemotor mit Ölbad - ausgestattet mit Enterprise-System mit Edelstahlplatte (Löcher ø 6 mm) und selbstschärfendem Edelmesser.
- ES** Estructura de aluminio pulido con tolva de acero inoxidable. Grupo de picar extraíble de acero inoxidable AISI 304 - boca de ø 52 mm para introducir la carne - reductor con engranajes en baño de aceite - en la dotación sistema enterprise con placa de acero inoxidable (agujeros ø 6 mm) y cuchilla de acero inoxidable con autoafilado.
- RU** Корпус из полированного алюминия с воронкой из нержавеющей стали. Съёмная режущая группа из нержавеющей стали AISI 304 - Мясоприемник ø 52 мм - Привод с масляной ванной - Система Enterprise с решеткой из нержавеющей стали (отверстия ø 6 мм) и самозатачивающимся ножом из нержавеющей стали.



GUARDA IL VIDEO
WATCH THE VIDEO

Inversione di marcia - Reverse function - Ревверс



OPTIONAL



69

	12S	
	0,75 kW (1 HP)	
	230-400V/3/50Hz	
	230V/1N/50Hz	
	100÷160 Kg/h	
	400 x 250 x 500(h) mm	
	21 Kg	
	23 Kg	
	540 x 300 x 480(h) mm	
	0,078 m³	
	<p>Gruppo di macinazione in alluminio Aluminium grinding unit Groupe de hachage en aluminium Zerkleinerungseinheit aus Aluminium Grupo de picar de aluminio Режущая группа из алюминий</p>	<p>Gruppo macinazione inox Stainless steel mincing unit Groupe de hachage en inox Zerkleinerungseinheit aus Edelstahl Grupo para picar de acero inoxidable Узел измельчения из нержавеющей стали</p>

Special Voltages - Разное питающее напряжение

49

12B













∅
52 mm

Tritacarne

MEAT MINCER
HACHOIR À VIANDE
FLEISCHWOLF
PICADORE DE CARNE
МЯСОРУБКА

- IT** Struttura in alluminio lucidato con tramoggia in acciaio inox. Bocca ingresso carne ø 52 mm - riduttore con ingranaggi a bagno d'olio - in dotazione sistema enterprise con piastra inox (fori ø 6 mm) e coltello inox autoaffilante.
- EN** Polished aluminium casing and stainless steel hopper. Meat inlet ø 52 mm - oiled gear motor - equipped with enterprise system with stainless steel plate (holes ø 6 mm) and self-sharpening stainless steel knife.
- FR** Corps en aluminium poli et trémie en acier inox. Orifice d'entrée viande ø 52 mm. Motoréducteur à engrenages à bain d'huile - de série, système enterprise avec plaque en inox (trous ø 6 mm) et couteau inox à aiguisement automatique.
- DE** Gehäuse aus poliertem Aluminium mit Trichter aus Edelstahl - Fleischeinführöffnung ø 52 mm - Getriebemotor mit Ölbad - ausgestattet mit Enterprise-System mit Edelstahlplatte (Löcher ø 6 mm) und selbstschärfendem Edelmessers.
- ES** Estructura de aluminio pulido con tolva de acero inoxidable. Boca para introducir la carne ø 52 mm - en la dotación sistema enterprise con placa de acero inoxidable (agujeros ø 6 mm) y cuchilla de acero inoxidable con autoafilado.
- RU** Корпус из полированного алюминия с воронкой из нержавеющей стали. Мясоприемник ø 52 мм - Привод с масляной ванной - Система Enterprise с решеткой из нержавеющей стали (отверстия ø 6 мм) и самозатачивающимся ножом из нержавеющей стали.

	12B	
	0,75 kW (1 HP)	
 1 Ph	230V/1N/50Hz	
 Kg/h	100÷160 Kg/h	
 mm	400 x 250 x 500(h) mm	
		
 Kg	21 Kg	
 Kg	23 Kg	
 mm	540 x 300 x 480(h) mm	
 m³	0,078 m³	
	<p>Gruppo di macinazione in alluminio</p> <p>Aluminium grinding unit</p> <p>Groupe de hachage en aluminium</p> <p>Zerkleinerungseinheit aus Aluminium</p> <p>Grupo de picar de aluminio</p> <p>Режущая группа из алюминий</p>	<p>Gruppo macinazione inox</p> <p>Stainless steel mincing unit</p> <p>Groupe de hachage en inox</p> <p>Zerkleinerungseinheit aus Edelstahl</p> <p>Grupo para picar de acero inoxidable</p> <p>Узел измельчения из нержавеющей стали</p>

Special Voltages - Разное питающее напряжение



22AT



22AT



GUARDA IL VIDEO
WATCH THE VIDEO



52 mm

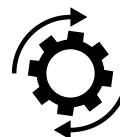

Inversione di marcia
Reverse function
Ревёрс



Abbinato Tritacarne e Grattugia

COMBINED MEAT MINCER AND GRATER
HACHOIR À VIANDE ET RÂPE COMBINÉS
KOMBINIERTER FLEISCHWOLF UND REIBE
PICADORA DE CARNE Y RALLADOR COMBINADOS
ДВОЙНАЯ ФУНКЦИЯ МЯСОРУБКИ И ТЕРКИ

IT Carcassa e tramoggia in acciaio inox. Macchina con gruppo di macinazione completamente removibile, che permette di poterlo collocare in frigorifero - il gruppo di macinazione in acciaio inox AISI 304 può essere lavato in lavastoviglie - bocca ingresso carne ø 52 mm - inversione di marcia - riduttore con ingranaggi a bagno d'olio. In dotazione sistema enterprise con piastra inox (fori ø 6 mm) e coltello inox autoaffilante. La parte della grattugia è caratterizzata da: bocca in alluminio lucidato 140x75 mm - rullo in acciaio inox - griglia inferiore di protezione - microinterruttore leva pressione grattugia.













EN Stainless steel casing and hopper. Machine with a completely removable grinding unit that allows it to be placed in the refrigerator - the grinding unit in stainless steel AISI 304 can be washed in the dishwasher - meat inlet ø 52 mm - reverse function - oiled gear motor. Equipped with enterprise system with stainless steel plate (holes ø 6 mm) and self-sharpening stainless steel knife. Grater section featured by: polished aluminium inlet 140x75 mm - stainless steel roller - lower protection grid - microswitch on the grater pusher.

FR Corps en aluminium poli avec trémie en acier inox. Machine avec groupe de hachage entièrement amovible qui permet de pouvoir le placer dans le réfrigérateur - l'unité de hachage en acier inox AISI 304 peut être lavée au lave-vaisselle - orifice d'entrée viande ø 52 mm - inversion de marche - motoréducteur à engrenages à bain d'huile. De série, système enterprise avec plaque en inox (trous ø 6 mm) et couteau inox aiguisement automatique. La partie de la râpe se caractérise par: orifice d'entrée en aluminium poli 140x75 mm - rouleau en acier inox - grille de protection inférieure - microrupteur à levier pour le bras pousseur.

DE Gehäuse aus poliertem Aluminium mit Trichter aus Edelstahl. Maschine mit Zerkleinerungseinheit, die vollständig abnehmbar ist und daher die Aufbewahrung im Kühlschrank gestattet ohne vorher nach jeder Verwendung in Übereinstimmung mit den HACCP Hygienevorschriften von den Hackfleischrückständen gereinigt zu werden, die Zerkleinerungseinheit aus Edelstahl AISI 304 kann in der Geschirrspülmaschine gereinigt werden. Fleischeinlassöffnung ø 52 mm - Umkehrgetriebe - Getriebemotor mit Ölbad - ausgestattet mit Enterprise-System mit Edelstahlplatte (Löcher ø 6 mm) und selbstschärfendem Edelmessers. Teile der Reibe: Einführöffnung aus poliertem Aluminium 140x75 mm - Rolle aus Edelstahl - unterer Schutzrost - Mikroschalter am Einfüllhebel der Reibe.

ES Carcasa de aluminio pulido con tolva de acero inoxidable. Máquina con grupo de picar completamente extraíble que permite poderlo colocar en la nevera - El grupo de picar de acero inoxidable AISI 304 puede ser limpiado en el lavavajillas - boca para introducir la carne ø 52 mm - inversión de marcha - reductor con engranajes en baño de aceite - en dotación sistema enterprise con placa de acero inoxidable (agujeros ø 6 mm) y cuchilla de acero inoxidable con autoafilado. La parte del rallador se caracteriza por: boca de aluminio pulido 140x75 mm - rodillo de acero inoxidable - rejilla inferior de protección - empujador con microinterruptor.

RU Корпус из полированного алюминия с воронкой из нержавеющей стали. Машина с полностью съемным измельчающим устройством, которое может храниться в холодильнике без предварительной очистки от мясного фарша после каждого использования в соответствии с гигиеническими нормами HACCP, узел измельчения из нержавеющей стали AISI 304 можно мыть в посудомоечной машине. Низковольтное управление - Мясоприемник ø 52 мм - Реверс - Привод с масляной ванной - Система Enterprise с решеткой из нержавеющей стали (отверстия ø 6 мм) и самозатачивающимся ножом из нержавеющей стали. Детали терки: приемный лоток из полированного алюминия 140x75 мм - цилиндр из нержавеющей стали - нижняя защитная решетка - микровыключатель на прижимном рычаге терки.

	22AT	
	1,1 kW (1,5 HP)	
	230-400V/3/50Hz	
	230V/1N/50Hz	
	 150÷250 Kg/h	 40 Kg/h
	560 x 430 x 480÷650(h) mm	
		
	38 Kg	
	48 Kg	
	770 x 520 x 580(h) mm	
	0,232 m³	
	<p>Gruppo di macinazione in alluminio Aluminium grinding unit Groupe de hachage en aluminium Zerkleinerungseinheit aus Aluminium Grupo de picar de aluminio Режущая группа из алюминий</p>	<p>Gruppo macinazione inox Stainless steel mincing unit Groupe de hachage en inox Zerkleinerungseinheit aus Edelstahl Grupo para picar de acero inoxidable Узел измельчения из нержавеющей стали</p>

Inox Unger System - Инокс Система Unger

Special Voltages - Разное питающее напряжение

22ATE



22ATE

∅
52 mm



Abbinato Tritacarne e Grattugia

COMBINED MEAT MINCER AND GRATER
HACHOIR À VIANDE ET RÂPE COMBINÉS
KOMBINIERTER FLEISCHWOLF UND REIBE
PICADORA DE CARNE Y RALLADOR COMBINADOS
ДВОЙНАЯ ФУНКЦИЯ МЯСОРУБКИ И ТЕРКИ

IT Carcassa e tramoggia in acciaio inox. Macchina con gruppo di macinazione completamente removibile, che permette di poterlo collocare in frigorifero - il gruppo di macinazione in acciaio inox AISI 304 può essere lavato in lavastoviglie - bocca ingresso carne ø 52 mm - riduttore con ingranaggi a bagno d'olio. In dotazione sistema enterprise con piastra inox (fori ø 6 mm) e coltello inox autoaffilante. La parte della grattugia è caratterizzata da: bocca in alluminio lucidato 140x75 mm - rullo in acciaio inox - griglia inferiore di protezione - microinterruttore leva pressione grattugia.















EN Stainless steel casing and hopper. Machine with a completely removable grinding unit that allows it to be placed in the refrigerator - the grinding unit in stainless steel AISI 304 can be washed in the dishwasher - meat inlet ø 52 mm - oiled gear motor. Equipped with enterprise system with stainless steel plate (holes ø 6 mm) and self-sharpening stainless steel knife. Grater section featured by: polished aluminium inlet 140x75 mm - stainless steel roller - lower protection grid - microswitch on the grater pusher.

FR Corps en aluminium poli avec trémie en acier inox. Machine avec groupe de hachage entièrement amovible qui permet de pouvoir le placer dans le réfrigérateur - l'unité de hachage en acier inox AISI 304 peut être lavée au lave-vaisselle - orifice d'entrée viande ø 52 mm - motoréducteur à engrenages à bain d'huile. De série, système enterprise avec plaque en inox (trous ø 6 mm) et couteau inox aiguisement automatique. La partie de la râpe se caractérise par: orifice d'entrée en aluminium poli 140x75 mm - rouleau en acier inox - grille de protection inférieure - microrupteur à levier pour le bras pousseur.

DE Gehäuse aus poliertem Aluminium mit Trichter aus Edelstahl. Maschine mit Zerkleinerungseinheit, die vollständig abnehmbar ist und daher die Aufbewahrung im Kühlschrank gestattet ohne vorher nach jeder Verwendung in Übereinstimmung mit den HACCP Hygienevorschriften von den Hackfleischrückständen gereinigt zu werden, die Zerkleinerungseinheit aus Edelstahl AISI 304 kann in der Geschirrspülmaschine gereinigt werden. Fleischeinlassöffnung ø 52 mm - Getriebemotor mit Ölbad - ausgestattet mit Enterprise-System mit Edelstahlplatte (Löcher ø 6 mm) und selbstschärfendem Edelmessers. Teile der Reibe: Einführöffnung aus poliertem Aluminium 140x75 mm - Rolle aus Edelstahl - unterer Schutzrost - Mikroschalter am Einfüllhebel der Reibe.

ES Carcasa de aluminio pulido con tolva de acero inoxidable. Máquina con grupo de picar completamente extraíble que permite poderlo colocar en la nevera - El grupo de picar de acero inoxidable AISI 304 puede ser limpiado en el lavavajillas - boca para introducir la carne ø 52 mm - reductor con engranajes en baño de aceite - en dotación sistema enterprise con placa de acero inoxidable (agujeros ø 6 mm) y cuchilla de acero inoxidable con autoafilado. La parte del rallador se caracteriza por: boca de aluminio pulido 140x75 mm - rodillo de acero inoxidable - rejilla inferior de protección - empujador con microinterruptor.

RU Корпус из полированного алюминия с воронкой из нержавеющей стали. Машина с полностью съемным измельчающим устройством, которое может храниться в холодильнике без предварительной очистки от мясного фарша после каждого использования в соответствии с гигиеническими нормами HACCP, узел измельчения из нержавеющей стали AISI 304 можно мыть в посудомоечной машине. Низковольтное управление - Мясоприемник ø 52 мм - Привод с масляной ванной - Система Enterprise с решеткой из нержавеющей стали (отверстия ø 6 мм) и самозатачивающимся ножом из нержавеющей стали. Детали терки: приемный лоток из полированного алюминия 140x75 мм - цилиндр из нержавеющей стали - нижняя защитная решетка - микровыключатель на прижимном рычаге терки.

	22ATE	
	1,1 kW (1,5 HP)	
	230-400V/3N/50Hz	
	230V/1N/50Hz	
	 150÷250 Kg/h	 40 Kg/h
	560 x 430 x 480÷650(h) mm	
		
		
	38 Kg	
	48 Kg	
	770 x 520 x 580(h) mm	
	0,232 m³	
	Gruppo di macinazione in alluminio Aluminium grinding unit Groupe de hachage en aluminium Zerkleinerungseinheit aus Aluminium Grupo de picar de aluminio Режущая группа из алюминий	Gruppo macinazione inox Stainless steel mincing unit Groupe de hachage en inox Zerkleinerungseinheit aus Edelstahl Grupo para picar de acero inoxidable Узел измельчения из нержавеющей стали

Inox Unger System - Инокс Система Unger

Special Voltages - Разное питающее напряжение



22T















∅
52 mm

Abbinato Tritacarne e Grattugia

COMBINED MEAT MINCER AND GRATER
HACHOIR À VIANDE ET RÂPE COMBINÉS
KOMBINIERTER FLEISCHWOLF UND REIBE
PICADORA DE CARNE Y RALLADOR COMBINADOS
ДВОЙНАЯ ФУНКЦИЯ МЯСОРУБКИ И ТЕРКИ

- IT** Abbinato tritacarne grattugia. Struttura in alluminio lucidato con tramoggia in acciaio inox - gruppo macinazione estraibile in acciaio inox AISI 304 - bocca ingresso carne ø 52 mm - riduttore con ingranaggi a bagno d'olio - in dotazione sistema - enterprise con piastra inox (fori ø 6 mm) e coltello inox autoaffilante. La parte della grattugia è caratterizzata da: bocca in alluminio lucidato 140x75 mm - rullo in acciaio inox - griglia inferiore di protezione - microinterruttore leva pressione grattugia.
- EN** Combined meat mincer and grater - polished aluminium casing and stainless steel hopper. Removable grinding unit in stainless steel AISI 304 - meat inlet ø 52 mm - oiled gear motor. Equipped with enterprise system with stainless steel plate (holes ø 6 mm) and self-sharpening stainless steel knife. Grater section featured by: polished aluminium inlet 140x75 mm - stainless steel roller - lower protection grid - microswitch on the grater pusher.
- FR** Combinée hachoir à viande et râpe - Corps en aluminium poli et trémie en acier inox - groupe de hachage amovible en acier inox AISI 304 - orifice d'entrée viande ø 52 mm - motoréducteur à engrenages à bain d'huile. De série, système enterprise avec plaque en inox (trous ø 6 mm) et couteau inox à aiguisement automatique. La partie de la râpe se caractérise par: orifice d'entrée en aluminium poli 140x75 mm - rouleau en acier inox - grille de protection inférieure - microrupteur à levier pour le bras pousseur.
- DE** Doppelfunktion Fleischwolf und Reibe - Gehäuse und Trichter aus Edelstahl - herausnehmbare Schneidegruppe aus Edelstahl AISI 304 - Fleisch-einführöffnung ø 52 mm - Getriebemotor mit Ölbad - ausgestattet mit Enterprise-System mit Edelstahlplatte (Löcher 6 mm) und selbstschärfendem Edelmessers. Teile der Reibe: Einführöffnung aus poliertem Aluminium 140x75 mm - Rolle aus Edelstahl - unterer Schutzrost - Mikroschalter am Einfüllhebel der Reibe.
- ES** Picadora de carne y rallador combinados. Estructura de aluminio pulido con tolva de acero inoxidable - grupo para picar de acero inoxidable AISI 304 completamente extraíble - boca de ø 52 mm para introducir la carne - reductor con engranajes en baño de aceite - inversión de la marcha - en la dotación sistema enterprise con placa de acero inoxidable (agujeros ø 6 mm) y cuchilla de acero inoxidable con autoafilado. La parte del rallador se caracteriza por: boca de aluminio pulido 140x75 mm - rodillo de acero inoxidable - rejilla inferior de protección - empujador con microinterruptor.
- RU** Двойная функция мясорубки и терки - Корпус и воронка из нержавеющей стали - Съёмная режущая группа из нержавеющей стали AISI 304 - Мясоприемник ø 52 мм - Привод с масляной ванной - Система Enterprise с решеткой из нержавеющей стали (отверстия ø 6 мм) и самозатачивающимся ножом из нержавеющей стали. Детали терки: приемный лоток из полированного алюминия 140x75 мм - цилиндр из нержавеющей стали - нижняя защитная решетка - микровыключатель на прижимном рычаге терки.

	22T	
	1,1 kW (1,5 HP)	
	230-400V/3/50Hz	
	230V/1N/50Hz	
	 150÷250 Kg/h	 40 Kg/h
	630 x 305 x 510÷660(h) mm	
		
	26 Kg	
	29 Kg	
	750 x 300 x 520(h) mm	
	0,117 m³	
	Gruppo di macinazione in alluminio Aluminium grinding unit Groupe de hachage en aluminium Zerkleinerungseinheit aus Aluminium Grupo de picar de aluminio Режущая группа из алюминий	Gruppo macinazione inox Stainless steel mincing unit Groupe de hachage en inox Zerkleinerungseinheit aus Edelstahl Grupo para picar de acero inoxidable Узел измельчения из нержавеющей стали

Inversione di marcia - Reverse function - Ревёрс



Inox Unger System - Инокс Система Unger

Special Voltages - Разное питающее напряжение

OPTIONAL



69

57

22AE



22AE













∅
52 mm

Abbinato Tritacarne e Grattugia

COMBINED MEAT MINCER AND GRATER
HACHOIR À VIANDE ET RÂPE COMBINÉS
KOMBINIERTER FLEISCHWOLF UND REIBE
PICADORA DE CARNE Y RALLADOR COMBINADOS
ДВОЙНАЯ ФУНКЦИЯ МЯСОРУБКИ И ТЕРКИ



- IT** Struttura in alluminio lucidato con tramoggia in acciaio inox - gruppo di macinazione inox AISI 304 completamente removibile che permette di poterlo collocare in frigorifero - bocca ingresso carne ø 52 mm - riduttore con ingranaggi a bagno d'olio - in dotazione sistema enterprise con piastra inox (fori ø 6 mm) e coltello inox autoaffilante. La parte della grattugia è caratterizzata da: bocca in alluminio lucidato 140x75 mm - rullo in acciaio inox - griglia inferiore di protezione - microinterruttore leva pressore grattugia.
- EN** Machine with a completely removable grinding unit in stainless steel AISI 304 that allows it to be placed in the refrigerator - meat inlet ø 52 mm - oiled gear motor. Equipped with enterprise system with stainless steel plate (ø 6 mm) and self-sharpening stainless steel knife. Grater section featured by: polished aluminium inlet 140x75 mm - stainless steel roller - lower protection grid - microswitch on the grater pusher.
- FR** Corps en aluminium poli avec trémie en acier inox - Machine avec groupe de hachage entièrement amovible en acier inox AISI 304 qui permet de pouvoir le placer dans le réfrigérateur - orifice d'entrée viande ø 52 mm - motoréducteur à engrenages à bain d'huile. De série, système enterprise avec plaque en inox (ø 6 mm) et couteau inox à aiguisement automatique. La partie de la râpe se caractérise par: orifice d'entrée en aluminium poli 140x75 mm - rouleau en acier inox - grille de protection inférieure - microrupteur à levier pour le bras pousseur.
- DE** Poliertes Aluminiumgehäuse mit Edelstahltrichter. Maschine mit Zerkleinerungseinheit aus Edelstahl AISI 304, die vollständig abnehmbar ist und daher die Aufbewahrung im Kühlschrank gestattet - Hygienevorschriften von den Hackfleischrückständen gereinigt zu werden. Fleischeinführöffnung ø 52 mm - Getriebemotor mit Ölbad - ausgestattet mit Enterprise-System mit Edelstahlplatte (6 mm) und selbstschärfendem Edelmessmesser. Teile der Reibe: Einführöffnung aus poliertem Aluminium 140x75 mm - Rolle aus Edelstahl - unterer Schutzrost - Mikroschalter am Einfüllhebel der Reibe.
- ES** Estructura de aluminio pulido con tolva de acero inoxidable - grupo para picar de acero inoxidable (AISI 304) completamente extraíble que permite poderlo colocar en la nevera - boca de ø 52 mm para introducir la carne - reductor con engranajes en baño de aceite - en la dotación sistema enterprise con placa de acero inoxidable (ø 6 mm) y cuchilla de acero inoxidable con autoafilado. La parte del rallador se caracteriza por: boca de aluminio pulido 140x75 mm - rodillo de acero inoxidable - rejilla inferior de protección - empujador con microinterruptor.
- RU** Корпус из полированного алюминия с воронкой из нержавеющей стали. Машина с измельчения из нержавеющей стали AISI 304 с полностью съемным измельчающим устройством, которое может храниться в холодильнике без предварительной очистки от мясного фарша после каждого использования в соответствии с гигиеническими нормами HACCP. Мясоприемник ø 52 мм - Привод с масляной ванной - Система Enterprise с решеткой из нержавеющей стали (ø 6 мм) и самозатачивающимся ножом из нержавеющей стали. Детали терки: приемный лоток из полированного алюминия 140x75 мм - цилиндр из нержавеющей стали - нижняя защитная решетка - микровыключатель на прижимном рычаге терки.

	22AE	
	1,1 kW (1,5 HP)	
	230-400V/3N/50Hz	
	230V/1N/50Hz	
	 150÷250 Kg/h	 40 Kg/h
	630 x 305 x 510÷660(h) mm	
		
	27 Kg	
	30 Kg	
	750 x 300 x 520(h) mm	
	0,117 m³	
	Gruppo di macinazione in alluminio Aluminium grinding unit Groupe de hachage en aluminium Zerkleinerungseinheit aus Aluminium Grupo de picar de aluminio Режущая группа из алюминий	Gruppo macinazione inox Stainless steel mincing unit Groupe de hachage en inox Zerkleinerungseinheit aus Edelstahl Grupo para picar de acero inoxidable Узел измельчения из нержавеющей стали

Inversione di marcia - Reverse function - Реверс



Inox Unger System - Инокс Система Unger

Special Voltages - Разное питающее напряжение

OPTIONAL



69

59

12AT



12AT













Ø
52 mm



Abbinato Tritacarne e Grattugia

COMBINED MEAT MINCER AND GRATER
HACHOIR À VIANDE ET RÂPE COMBINÉS
KOMBINIERTER FLEISCHWOLF UND REIBE
PICADORA DE CARNE Y RALLADOR COMBINADOS
ДВОЙНАЯ ФУНКЦИЯ МЯСОРУБКИ И ТЕРКИ

- IT** Struttura in alluminio lucidato con tramoggia in acciaio inox - gruppo di macinazione inox AISI 304 completamente removibile che permette di poterlo collocare in frigorifero - bocca ingresso carne ø 52 mm - riduttore con ingranaggi a bagno d'olio - in dotazione sistema enterprise con piastra inox (ø 6 mm) e coltello inox autoaffilante. La parte della grattugia è caratterizzata da: bocca in alluminio lucidato 140x75 mm - rullo in acciaio inox - griglia inferiore di protezione - microinterruttore leva pressore grattugia.
- EN** Machine with a completely removable grinding unit in stainless steel AISI 304 that allows it to be placed in the refrigerator - meat inlet ø 52 mm - oiled gear motor. Equipped with enterprise system with stainless steel plate (ø 6 mm) and self-sharpening stainless steel knife. Grater section featured by: polished aluminium inlet 140x75 mm - stainless steel roller - lower protection grid - microswitch on the grater pusher.
- FR** Corps en aluminium poli avec trémie en acier inox - machine avec groupe de hachage entièrement amovible en acier inox AISI 304 qui permet de pouvoir le placer dans le réfrigérateur - orifice d'entrée viande ø 52 mm - motoréducteur à engrenages à bain d'huile. De série, système enterprise avec plaque en inox (ø 6 mm) et couteau inox à aiguisement automatique. La partie de la râpe se caractérise par: orifice d'entrée en aluminium poli 140x75 mm - rouleau en acier inox - grille de protection inférieure - microrupteur à levier pour le bras pousseur.
- DE** Poliertes Aluminiumgehäuse mit Edelstahltrichter. Maschine mit Zerkleinerungseinheit aus Edelstahl AISI 304, die vollständig abnehmbar ist und daher die Aufbewahrung im Kühlschrank gestattet - Hygienevorschriften von den Hackfleischrückständen gereinigt zu werden. Fleischeinführöffnung ø 52 mm - Getriebemotor mit Ölbad - ausgestattet mit Enterprise-System mit Edelstahlplatte (6 mm) und selbstschärfendem Edelmesser. Teile der Reibe: Einführöffnung aus poliertem Aluminium 140x75 mm - Rolle aus Edelstahl - unterer Schutzrost - Mikroschalter am Einfüllhebel der Reibe.
- ES** Estructura de aluminio pulido con tolva de acero inoxidable - grupo para picar de acero inoxidable (AISI 304) completamente extraíble que permite poderlo colocar en la nevera - boca de ø 52 mm para introducir la carne - reductor con engranajes en baño de aceite - en la dotación sistema enterprise con placa de acero inoxidable (ø 6 mm) y cuchilla de acero inoxidable con autoafilado. La parte del rallador se caracteriza por: boca de aluminio pulido 140x75 mm - rodillo de acero inoxidable - rejilla inferior de protección - empujador con microinterruptor.
- RU** Корпус из полированного алюминия с воронкой из нержавеющей стали. Машина с измельчения из нержавеющей стали AISI 304 с полностью съемным измельчающим устройством, которое может храниться в холодильнике без предварительной очистки от мясного фарша после каждого использования в соответствии с гигиеническими нормами HACCP. Мясоприемник ø 52 мм - Привод с масляной ванной - Система Enterprise с решеткой из нержавеющей стали (ø 6 мм) и самозатачивающимся ножом из нержавеющей стали. Детали терки: приемный лоток из полированного алюминия 140x75 мм - цилиндр из нержавеющей стали - нижняя защитная решетка - микровыключатель на прижимном рычаге терки.

	12AT	
	0,75 kW (1 HP)	
	230-400V/3/50Hz	
	230V/1N/50Hz	
	 100÷160 Kg/h	 40 Kg/h
	605 x 305 x 510+600(h) mm	
		
	26 Kg	
	30 Kg	
	750 x 300 x 520(h) mm	
	0,117 m³	
	Gruppo di macinazione in alluminio Aluminium grinding unit Groupe de hachage en aluminium Zerkleinerungseinheit aus Aluminium Grupo de picar de aluminio Режущая группа из алюминий	Gruppo macinazione inox Stainless steel mincing unit Groupe de hachage en inox Zerkleinerungseinheit aus Edelstahl Grupo para picar de acero inoxidable Узел измельчения из нержавеющей стали

Inversione di marcia - Reverse function - Реверс



Inox Unger System - Инокс Система Unger

Special Voltages - Разное питающее напряжение

OPTIONAL



69

61

12T















∅
52 mm

Abbinato Tritacarne e Grattugia

COMBINED MEAT MINCER AND GRATER
HACHOIR À VIANDE ET RÂPE COMBINÉS
KOMBINIERTER FLEISCHWOLF UND REIBE
PICADORA DE CARNE Y RALLADOR COMBINADOS
ДВОЙНАЯ ФУНКЦИЯ МЯСОРУБКИ И ТЕРКИ

- IT** Abbinato tritacarne e grattugia. Struttura in alluminio lucidato con tramoggia in acciaio inox - gruppo di macinazione estraibile in acciaio inox AISI 304 - bocca ingresso carne \varnothing 52 mm - riduttore con ingranaggi a bagno d'olio - in dotazione sistema enterprise con piastra inox (fori \varnothing 6 mm) e coltello inox autoaffilante - la parte della grattugia è caratterizzata da bocca in alluminio lucidato 140x75 mm - rullo in acciaio inox - griglia inferiore di protezione - microinterruttore leva pressione grattugia.
- EN** Combined meat mincer and grater - polished aluminium casing and stainless steel hopper. Removable grinding unit in stainless steel AISI 304 - meat inlet \varnothing 52 mm - oiled gear motor. Equipped with enterprise system with stainless steel plate (holes \varnothing 6 mm) and self-sharpening stainless steel knife. Grater section featured by: polished aluminium inlet 140x75 mm - stainless steel roller - lower protection grid - microswitch on the grater pusher.
- FR** Combinée hachoir à viande et râpe - Corps en aluminium poli et trémie en acier inox - groupe de hachage amovible en acier inox AISI 304 - orifice d'entrée viande \varnothing 52 mm - motoréducteur à engrenages à bain d'huile. De série, système enterprise avec plaque en inox (trous \varnothing 6 mm) et couteau inox à aiguisement automatique. La partie de la râpe se caractérise par: orifice d'entrée en aluminium poli 140x75 mm - rouleau en acier inox - grille de protection inférieure - microrupteur à levier pour le bras pousseur.
- DE** Doppelfunktion Fleischwolf und Reibe - Gehäuse aus poliertem Aluminium und Trichter aus Edelstahl - herausnehmbare Schneidegruppe aus Edelstahl AISI 304 - Fleischeinführöffnung \varnothing 52 mm - Getriebemotor mit Ölbad - ausgestattet mit Enterprise-System mit Edelstahlplatte (Löcher 6 mm) und selbstschärfendem Edelstahlmesser. Teile der Reibe: Einführöffnung aus poliertem Aluminium 140x75 mm - Rolle aus Edelstahl - unterer Schutzrost - Mikroschalter am Einfüllhebel der Reibe.
- ES** Picadora de carne y rallador combinados. Estructura de aluminio pulido con tolva de acero inoxidable - grupo para picar de acero inoxidable AISI 304 completamente extraíble - boca de \varnothing 52 mm para introducir la carne - reductor con engranajes en baño de aceite - en la dotación sistema enterprise con placa de acero inoxidable (agujeros \varnothing 6 mm) y cuchilla de acero inoxidable con autoafilado. La parte del rallador se caracteriza por: boca de aluminio pulido 140x75 mm - rodillo de acero inoxidable - rejilla inferior de protección - empujador con microinterruptor.
- RU** Двойная функция мясорубки и терки - Корпус и воронка из нержавеющей стали - Съёмная режущая группа из нержавеющей стали AISI 304 - Мясоприемник \varnothing 52 мм - Привод с масляной ванной - Система Enterprise с решеткой из нержавеющей стали (отверстия \varnothing 6 мм) и самозатачивающимся ножом из нержавеющей стали. Детали терки: приемный лоток из полированного алюминия 140x75 мм - цилиндр из нержавеющей стали - нижняя защитная решетка - микровыключатель на прижимном рычаге терки.

	12T	
	0,75 kW (1 HP)	
	230-400V/3/50Hz	
	230V/1N/50Hz	
	 100÷160 Kg/h	 40 Kg/h
	590 x 290 x 510+600(h) mm	
		
	23 Kg	
	26 Kg	
	750 x 300 x 520(h) mm	
	0,117 m³	
	Gruppo di macinazione in alluminio Aluminium grinding unit Groupe de hachage en aluminium Zerkleinerungseinheit aus Aluminium Grupo de picar de aluminio Режущая группа из алюминий	Gruppo macinazione inox Stainless steel mincing unit Groupe de hachage en inox Zerkleinerungseinheit aus Edelstahl Grupo para picar de acero inoxidable Узел измельчения из нержавеющей стали

Inversione di marcia - Reverse function - Ревверс



Special Voltages - Разное питающее напряжение

OPTIONAL



69

63

GR12S













GR12S

Grattugia

GRATER
RAPE
KÄSEREIBE
RALLADOR
TEPKA

- IT** Struttura e bocca in alluminio lucidato - dimensione della bocca 140x75 mm - rullo in acciaio inox - griglia inferiore di protezione - microinterruttore leva pressore grattugia - versione CE con freno motore.
- EN** Polished aluminium casing and inlet - inlet size 140x75 mm - stainless steel roller - lower protection grid - grater presser lever switch - CE version with motor brake.
- FR** Corps et orifice en aluminium poli - dimensions de l'orifice 140x75 mm - rouleau en acier inox - grille inférieure de protection - micro-interrupteur bras pousseur râpe - version CE avec frein moteur.
- DE** Gehäuse und Einführöffnung aus poliertem Aluminium - Einführöffnungsgröße 140x75 mm - Rolle aus Edelstahl - unterer Schutzrost - Mikroschalter am Hebel des Reibenniederhalters - CE-Version mit Motorbremse.
- ES** Estructura y boca de aluminio pulido - tamaño de boca de inserción 140x75 mm - rodillo de acero inoxidable - rejilla inferior de protección - microinterruptor palanca prensador rallador - versión CE con freno motor.
- RU** Корпус и мясоприемник из полированного алюминия, размеры мясоприемник 140x75 мм ролик из нержавеющей стали, нижняя защитная решетка, микровыключатель на прижимном рычаге терки, исполнение CE с тормозом двигателя.

	GR12S
	0,75 kW (1 HP)
	230-400V/3/50Hz
	230V/1N/50Hz
	40 Kg/h
	430 x 290 x 390+600(h) mm
	
	17 Kg
	19 Kg
	470 x 300 x 520(h) mm
	0,073 m³

Senza freno motore e senza bassa tensione
Without motor brake and low voltage
Без тормоза двигателя и низкого напряжения

Senza freno motore, con bassa tensione
Without motor brake, with low tension
Sans frein moteur avec basse tension
Ohne Motorenbremse, mit Niederspannung
Sin freno motor con baja tensión
Без торможения двигателя под низким напряжением

Con freno motore
With motor brake
Avec frein moteur
Mit Motorenbremse
Con freno motor
торможением двигателя

Special Voltages - Разное питающее напряжение

AB8D
TR8D
GR8D



GR8D



52 mm



TR8D



52 mm



AB8D

Abbinato
Tritacarne e Grattugia

COMBINED MEAT MINCER AND GRATER
HACHOIR À VIANDE ET RÂPE COMBINÉS
KOMBINIERTER FLEISCHWOLF UND REIBE
PICADORA DE CARNE Y RALLADOR COMBINADOS
ДВОЙНАЯ ФУНКЦИЯ МЯСОРУБКИ И ТЕРКИ

SEMI PROFESSIONAL

IT AB8D: Struttura in alluminio lucidato con tramoggia in acciaio inox - gruppo macinazione in alluminio - bocca ingresso carne ø 52 mm - in dotazione sistema enterprise con piastra inox (fori ø 6 mm) e coltello inox autoaffilante. La parte della grattugia è caratterizzata da: bocca in alluminio lucidato 105x65 mm - rullo in acciaio inox - griglia inferiore di protezione - microinterruttore leva pressore grattugia.

TR8D: Struttura in alluminio lucidato con tramoggia in acciaio inox - gruppo macinazione in alluminio - bocca ingresso carne ø 52 mm - riduttore con ingranaggi a bagno d'olio - in dotazione sistema enterprise con piastra inox (fori ø 6 mm) e coltello inox autoaffilante.

GR8D: Struttura e bocca in alluminio lucidato 105x65 mm - rullo in acciaio inox - griglia inferiore di protezione - microinterruttore leva pressore grattugia.

FR AB8D: Corps en aluminium poli et trémie en acier inox - groupe de hachage en aluminium - orifice d'entrée viande ø 52 mm. De série, système enterprise avec plaque en inox (trous ø 6 mm) et couteau inox à aiguisement automatique. La partie de la râpe se caractérise par: orifice d'entrée en aluminium poli 105x65 mm - rouleau en acier inox - grille de protection inférieure - microrupteur à levier sour le bras pousseur.

TR8D: Corps en aluminium poli et trémie en acier inox - groupe de hachage en aluminium - orifice d'entrée viande ø 52 mm - motoréducteur à engrenages à bain d'huile. De série, système enterprise avec plaque en inox (trous ø 6 mm) et couteau inox à aiguisement automatique.

GR8D: Corps et orifice d'entrée en aluminium poli 105x65 mm - rouleau en acier inox - grille de protection inférieure - microrupteur à levier sour le bras pousseur.

ES AB8D: Estructura de aluminio pulido con tolva de acero inoxidable - grupo para picar de aluminio - boca para introducir la carne ø 52 mm - en la dotación sistema enterprise con placa de acero inoxidable (agujeros ø 6 mm) y cuchilla de acero inoxidable con autoafilado. La parte del rallador se caracteriza por: boca de aluminio pulido 105x65 mm - rodillo de acero inoxidable - rejilla inferior de protección - empujador con microinterruptor.

TR8D: Estructura de aluminio pulido con tolva de acero inoxidable - grupo para picar de aluminio - boca para introducir la carne ø 52 mm - en la dotación sistema enterprise con placa de acero inoxidable (agujeros ø 6 mm) y cuchilla de acero inoxidable con autoafilado.

GR8D: Estructura y boca de aluminio pulido 105x65 mm - rodillo de acero inoxidable - rejilla inferior de protección - empujador con microinterruptor.

EN AB8D: Polished aluminium casing and stainless-steel hopper. Aluminium grinding unit - meat inlet ø 52 mm. Equipped with enterprise system with stainless steel plate (holes ø 6 mm) and self-sharpening stainless steel knife. Grater section featured by: polished aluminium inlet 105x65 mm - stainless steel roller - lower protection grid - microswitch on the grater pusher.

TR8D: Polished aluminium casing and stainless-steel hopper. Aluminium grinding unit - meat inlet ø 52 mm - oiled gear motor - equipped with enterprise system with stainless steel plate (holes ø 6 mm) and self-sharpening stainless-steel knife.

GR8D: polished aluminium structure and inlet 105x65 mm - stainless steel roller - lower protection grid - microswitch on the grater pusher.

DE AB8D: Gehäuse aus poliertem Aluminium und Trichter aus Edelstahl - Schneidegruppe aus Aluminium - Fleischeinführöffnung ø 52 mm - ausgestattet mit Enterprise-System mit Edelstahlplatte (Löcher ø 6 mm) und selbstschärfendem Edelmesser. Teile der Reibe: Einführöffnung aus poliertem Aluminium 105x65 mm - Rolle aus Edelstahl - unterer Schutzrost - Mikroschalter am Einfüllhebel der Reibe.













TR8D: Gehäuse aus poliertem Aluminium mit Trichter aus Edelstahl - Schneidegruppe aus Aluminium - Fleischeinführöffnung ø 52 mm - Getriebemotor mit Ölbad - ausgestattet mit Enterprise-System mit Edelstahlplatte (Löcher ø 6 mm) und selbstschärfendem Edelmesser.

GR8D: Struktur und Einführöffnung aus poliertem Aluminium 105x65 mm - Rolle aus Edelstahl - unterer Schutzrost - Mikroschalter am Einführhebel der Reibe.

RU AB8D: Корпус и воронка из нержавеющей стали - Режущий узел из алюминия - Мясоприемник ø 52 мм - Система Enterprise с решеткой из нержавеющей стали (отверстия ø 6 мм) и самозатачивающимся ножом из нержавеющей стали. Детали терки: приемный лоток из полированного алюминия 105x65 мм - цилиндр из нержавеющей стали - нижняя защитная решетка - микровыключатель на прижимном рычаге терки.

TR8D: Корпус из полированного алюминия с воронкой из нержавеющей стали - Режущий узел из алюминия - Мясоприемник ø 52 мм - Привод с масляной ванной - Система Enterprise с решеткой из нержавеющей стали (отверстия ø 6 мм) и самозатачивающимся ножом из нержавеющей стали.

GR8D: Корпус и мясоприемник из полированного алюминия 105x65 мм - цилиндр из нержавеющей стали - нижняя защитная решетка - микровыключатель на прижимном рычаге терки.

	AB8D	TR8D	GR8D
	0,37 kW (0,5 HP)		
	230V/1N/50Hz		
	 20+50 Kg/h	 20 Kg/h	 20+50 Kg/h
	430 x 270 x 360÷420(h) mm	290 x 270 x 350(h) mm	290 x 250 x 310÷420(h) mm
			
	11 Kg	9 Kg	8 Kg
	12 Kg	10 Kg	9 Kg
	390 x 310 x 370(h) mm	320 x 270 x 380(h) mm	
	0,045 m³	0,033 m³	

Special Voltages - Разное питающее напряжение

Optional

ACCESSORIES
ACCESSOIRES
ZUBEHÖR
ACCESORIOS
AKCECCYAPЫ



Imbuto tritacarne - Mincer funnel - Entonnoir pour hachoir à viande Fleischwolftrichter - Embudo para picadora de carne - Воронка для мяса				
Mod.	8	12	22	32
Ø 15 mm	IMBUTO810	IMBUTO1210	IMBUTO2210	-
Ø 20 mm	IMBUTO820	IMBUTO1220	IMBUTO2220	IMBUTO3220
Ø 30 mm	-	-	IMBUTO2230	IMBUTO3230

Passapomodoro - Tomato Pulper - Passe-Tomates - Tomatenpürierer
Pasador de tomate - Насадка для томатов

Mod. 12

PPOMODORO

SISTEMA UNGER STANDARD

STANDARD UNGER SYSTEM
SYSTÈME UNGER STANDARD
STANDARD UNGERSYSTEM
SISTEMA UNGER ESTÁNDAR
СТАНДАРТНАЯ СИСТЕМА UNGER

A) Corpo tritacarne
Mincer body
Corps hache-viande
Fleischwolfkörper
Cuerpo picadora de carne
Корпус мясорубки

D) Coltello
Blade
Couteau
Messer
Cuchilla
Нож

B) Coclea
Screw conveyor
Vis transporteuse
Förderschnecke
Tornillo sinfín
Шнек

E) Piastra ø8
Plate ø8
Grille ø8
Lochscheibe ø8
Placa ø8
Решетка ø8

C) Piastra sgrossatrice 0
Large grater plate 0
Grille dégrossisseuse 0
Grob-Lochscheibe 0
Placa para desbastar 0
Крупная подрезная
решетка 0

F) Piastra ø4.5
Plate ø4.5
Grille ø4.5
Lochscheibe ø4.5
Placa ø4.5
Решетка ø4.5

G) Volantino
Handwheel
Manivelle
Handrad
Volante
Рукоятка мясорубки

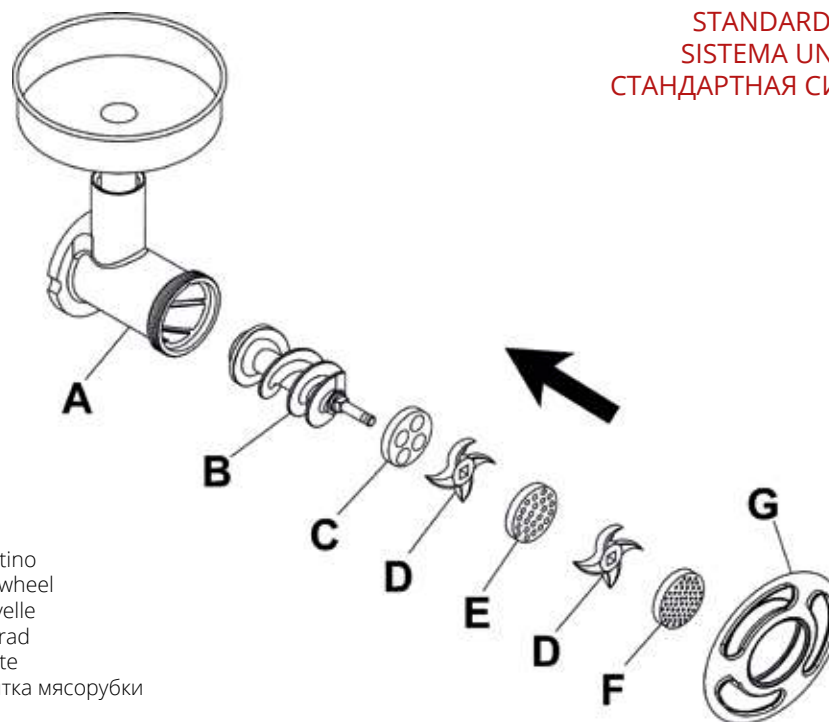



ENTERPRISE

Coltelli Enterprise in acciaio inox - Enterprise stainless steel knives - Couteaux Enterprise en acier inox
Enterprise messer aus Edelstahl - Cuchillas Enterprise de acero inoxidable - Ножи "Enterprise" из нержавеющей стали

Mod.	8		12 (R70)		22 (H82)		32 (B98)	
	COL8I		COL12I		COL22I		COL32I	

Piastre Enterprise in acciaio inox - Enterprise stainless steel perforated disks - Grilles Enterprise en acier inox
Enterprise Edelstahl Lochscheiben - Placas Enterprise de acero inoxidable - Решетки Enterprise Иноук



Mod.	8		12 (R70)		22 (H82)		32 (B98)	
	Ø 2 mm	PIA8I2	-		PIA22I2		PIA32I2	
	Ø 3 mm	PIA8I3	PIA12I3		PIA22I3		PIA32I3	
	Ø 3.5 mm	PIA8I35	PIA12I35		PIA22I35		PIA32I35	
	Ø 4 mm	PIA8I4	-		-		PIA32I45	
	Ø 4.5 mm	PIA8I45	PIA12I45		PIA22I45		-	
	Ø 6 mm	PIA8I6	PIA12I6		PIA22I6		PIA32I6	
	Ø 8 mm	PIA8I8	PIA12I8		PIA22I8		PIA32I8	
	Ø 10 mm	PIA8I10	PIA12I10		PIA22I10		PIA32I10	
	Ø 12 mm	PIA8I12	PIA12I12		PIA22I12		PIA32I12	
	Ø 13 mm	PIA8I13	-		-		-	
	Ø 14 mm	PIA8I14	PIA12I14		PIA22I14		PIA32I14	
	Ø 16 mm	PIA8I16	PIA12I16		PIA22I16		PIA32I16	
	Ø 18 mm	-	PIA12I18		PIA22I18		PIA32I18	
	Ø 20 mm	-	PIA12I20		PIA22I20		PIA32I20	

UNGER

Coltelli Unger in acciaio inox - Unger stainless steel perforated knives - Couteaux Unger en acier inox
Unger messer aus Edelstahl - Cuchillas Unger de acero inoxidable - Ножи Unger из нержавеющей стали

Mod.	12 (R70)	22 (H82)	32 (B98)
	COL12U	COL22U	COL32U

Piastre Unger in acciaio inox - Unger stainless steel perforated disks - Grilles Unger en acier inox
Unger Edelstahllochscheiben - Placas Unger de acero inoxidable - Решетки Unger Инокс

Mod.	12 (R70)	22 (H82)	32 (B98)	
	Ø 2 mm	PIA12U2	PIA22U2	PIA32U2
	Ø 2.5 mm	PIA12U25	PIA22U25	PIA32U25
	Ø 3 mm	PIA12U3	PIA22U3	PIA32U3
	Ø 3.5 mm	PIA12U35	PIA22U35	PIA32U35
	Ø 4 mm	PIA12U4	PIA22U4	PIA32U4
	Ø 4.5 mm	PIA12U45	PIA22U45	PIA32U45
	Ø 6 mm	PIA12U6	PIA22U6	PIA32U6
	Ø 8 mm	PIA12U8	PIA22U8	PIA32U8
	Ø 10 mm	PIA12U10	PIA22U10	PIA32U10
	Ø 12 mm	PIA12U12	PIA22U12	PIA32U12
	Ø 13 mm	PIA12U13	PIA22U13	PIA32U13
	Ø 14 mm	PIA12U14	PIA22U14	PIA32U14
	Ø 16 mm	PIA12U16	PIA22U16	PIA32U16
	Ø 18 mm	PIA12U18	PIA22U18	PIA32U18
	Ø 20 mm	PIA12U20	PIA22U20	PIA32U20
	Piastra sgrossatrice 0 - Large grater plate 0 - Grille dégrossisseuse 0 - Grob-Lochscheibe 0 - Placa para desbastar 0 - Решетка крупная 0			
	PIA12U0	PIA22U0	PIA32U0	

OPTIONAL

SE1550A-V
SE1830A-V
SE2020A-V



SE1830A
ANODIZZATO / ANODISED



SE1830V
VERNICIATO / PAINTED

Segaossi a nastro
anodizzato - verniciato

BONE BANDSAW
SCIÉ À OS
LACKIERTE KNOCHENBANDSÄGE
SIERRAS PARA HUESOS
ЛЕНТОЧНАЯ ПИЛА ДЛЯ КОСТЕЙ

IT Struttura in alluminio anodizzato (SE1550A-1830A-2020A) o verniciato (SE1550V-1830V-2020V) - pulsante di emergenza - microinterruttore su coperchio di chiusura macchina - freno motore - regolazione dello spessore di taglio - regolazione dell'altezza di taglio - porzionatore, piano di lavoro, guida lama e spingi carne in acciaio inox.
Accessori: cavalletto in acciaio verniciato - confezione di lame.

FR Corps en aluminium anodisé (SE1550A-1830A-2020A) ou en aluminium peint (SE1550V-1830V-2020V) - bouton d'arrêt d'urgence - micro-interrupteur sur le couvercle de la machine - frein moteur - réglage de l'épaisseur de coupe - réglage de la hauteur de coupe - dispositif de portionnement, plan de travail, guide couteau et poussoir de viande en acier inox.
Accessoires: Support en acier verni, Paquet de lames.

ES Estructura de aluminio anodizado (SE1550A-1830A-2020A) o aluminio pintado (SE1550V-1830V-2020V) - botón de emergencia - microinterruptor en la tapa de cierre de la máquina - freno motor - regulación del espesor del corte - regulación de la altura del corte - porcionadora, superficie de trabajo, guía cuchilla y empuja carne de acero inoxidable.
Accesorios: Caballete de acero pintado - paquete de cuchillas.

EN Anodised aluminium structure (SE1550A-1830A-2020A) or painted aluminium structure (SE1550V-1830V-2020V) - emergency stop button - microswitch on the machine lid - motor brake - cutting thickness adjustment - cutting height adjustment - stainless steel portioning device, work surface, knife guide and meat pusher.
Accessories: Painted steel stand - set of blades.

DE Gehäuse aus eloxiertem Aluminium (SE1550A-1830A-2020A) oder lackiertem Aluminium (SE1550V-1830V-2020V) - Notaus-Schalter - Mikroschalter auf Maschinenverschlussdeckel - Motorbremse - Einstellung der Schnittstärke - Einstellung der Schnitthöhe - Portionier Vorrichtung, Arbeitsfläche, Messerführung und Fleischschieber aus Edelstahl.
Zubehör: Gestell aus lackiertem Stahl - Messersatz.









RU Корпус из анодированного алюминия (SE1550A-1830A-2020A) или окрашенного алюминия (SE1550V-1830V-2020V) - Аварийный выключатель - Микропереключатель на крышке машины - Моторный тормоз - Регулировка толщины резки - регулировка высоты резки - порционирующее устройство, рабочая поверхность, направляющая лезвия и пестик для мяса из нержавеющей стали.
Аксессуары: Рама из лакированной стали - набор ножей.



CAVSE

CAVSE	
	Cavalletto verniciato - Painted steel stand Рама из лакированной стали
	550 x 570 x 650(h) mm

Lame - Blade Lames - Messersatz - лезвия			
	(1500 - 1900 mm)	(1910 - 2400 mm)	(2410 - 2960 mm)

	ANODIZZATO / ANODISED			VERNICIATO / PAINTED		
	SE1550A	SE1830A	SE2020A	SE1550V	SE1830V	SE2020V
	0,75 kW (1 HP)		1 kW (1,5 HP)	0,75 kW (1 HP)		1 kW (1,5 HP)
	230-400V/3/50Hz					
	230V/1N/50Hz					
	ø 1550 mm 170 x 150(h) mm	ø 1830 mm 200 x 225(h) mm	ø 2020 mm 230 x 290(h) mm	ø 1550 mm 170 x 150(h) mm	ø 1830 mm 200 x 225(h) mm	ø 2020 mm 230 x 290(h) mm
	330 x 300 mm	410 x 410 mm	535 x 500 mm	330 x 300 mm	410 x 410 mm	535 x 500 mm
	530 x 400 x 850(h) mm	630 x 450 x 970(h) mm	750 x 500 x 1070(h) mm	530 x 400 x 850(h) mm	630 x 450 x 970(h) mm	750 x 500 x 1070(h) mm
						
	37 Kg	39 Kg	52 Kg	37 Kg	39 Kg	52 Kg
	45 Kg	47 Kg	63 Kg	45 Kg	47 Kg	63 Kg
	1020 x 560 x 500(h) mm		1150 x 560 x 570(h) mm	1020 x 560 x 500(h) mm		1150 x 560 x 570(h) mm
	0,286 m ³		0,387 m ³	0,286 m ³		0,387 m ³

Special Voltages - Разное питающее напряжение

Impastatrici per carne

MEAT MIXER
MELANGEUR À VIANDE
FLEISCH MISCHMASCHINEN
AMASADORAS PARA CARNE
ФАРШЕМЕШАЛКИ

30C1PN
50C1PN-50C2PN
75C1PN-95C2PN
115C2PN-150C2PN

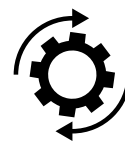

Inversione di marcia
Reverse function
Реверс



50C2PN



30C1PN

- IT Impastatrici per carne. Struttura interamente in acciaio inox sabbiato - microinterruttore su coperchio - inversione di marcia - pulsante di emergenza - ribaltamento della vasca (110°) per facilitarne lo svuotamento - pale estraibili - kit ruote (di cui 2 con freno) di serie.
- FR Mélangeurs de viande. Corps entièrement en acier inox sablé - micro-interrupteur sur le couvercle - inversion de marche - bouton d'arrêt d'urgence - cuve basculante (110°) pour faciliter le vidage - lames amovibles - kit roue (dont 2 avec frein) de série.
- ES Amasadoras de carne. Estructura completamente de acero inoxidable arenado - microinterruptor con tapa - inversión de la marcha - botón de emergencia - el recipiente se puede volcar (110°) para facilitar su vaciado - palas extraíbles. Kit de ruedas (2 con freno) en el equipamiento de serie.

- EN Meat kneader. Sanded stainless steel structure - micro switch on lid - reverse function - emergency stop button - tank tilting (110°) for easy emptying - removable blades. Wheel kit (2 of which with brake) as standard.
- DE Fleischmixer. Gehäuse komplett aus sandgestrahltem Edelstahl - Mikroschalter am Deckel - Umkehrgetriebe - Notaus-Schalter - Wannenkippung (110°) zur Entleerungserleichterung - herausnehmbare Schaufeln. Radsatz (davon 2 mit Bremse) serienmäßig.
- RU Мясной смеситель. Корпус из нержавеющей стали с пескоструйной обработкой - Микропереключатель на крышке машины - Реверс - Аварийный выключатель - Наклон трубы (110°) облегчение опорожнения - съемные лопасти. Колесная пара (2 с тормозом) в стандартной комплектации.



Inversione di marcia
Reverse function
Реверс



PALE ESTRAIBILI
REMOVABLE BLADES
СЪЕМНЫЕ ЛОПАСТИ

	30C1PN	50C1PN	50C2PN	75C1PN	95C2PN	115C2PN	150C2PN
	0,37 kW (0,5 HP)	0,55 kW (0,7 HP)	1,5 kW (2 HP)	0,75 kW (1 HP)	1,5 kW (2 HP)	1,8 kW (2,5 HP)	
	230-400V/3/50Hz						
	230V/1N/50Hz			-			
	42 L	72 L	78 L	108 L	145 L	177 L	200 L
	Min. 12 - Max. 30 Kg	Min. 20 - Max. 50 Kg		Min. 30 - Max. 75 Kg	Min. 38 - Max. 95 Kg	Min. 50 - Max. 120 Kg	Min. 56 - Max. 140 Kg
	380 x 300 x 390(h) mm	415 x 390 x 470(h) mm	415 x 500 x 385(h) mm	630 x 390 x 475(h) mm	790 x 500 x 385(h) mm	697 x 550 x 475(h) mm	875 x 550 x 475(h) mm
	30 rpm						
	700 x 420 x 1025(h) mm	800 x 570 x 1031(h) mm		980 x 520 x 1145(h) mm	1160 x 570 x 1031(h) mm	1090 x 640 x 1126(h) mm	1260 x 630 x 1126(h) mm
	1		2	1	2		
							
	40 Kg	80 Kg	100 Kg	85 Kg	110 Kg	115 Kg	120 Kg
	65 Kg	90 Kg	117 Kg	95 Kg	127 Kg	132 Kg	140 Kg
	830 x 550 x 1060(h) mm	1220 x 670 x 1150(h) mm		1220 x 680 x 1150(h) mm			
	0,048 m³	0,940 m³		0,950 m³			

Special Voltages - Разное питающее напряжение

LT7OR-LT7VE
LT14OR-LT14VE











Insaccatrici manuali

MANUAL STAINLESS STEEL
SAUSAGE FILLERS
POUSOIRS À SAUCISSES MANUELS
MANUELLE WURSTFÜLLMASCHINEN
EMBUTIDORAS MANUALES DE ACERO INOXIDABLE
РУЧНЫЕ НАПОЛНИТЕЛИ КОЛБАС ИЗ НЕРЖАВЕЮЩЕЙ

- IT** Struttura in acciaio inox - pistone in alluminio - 2 velocità: una lenta per l'avanzamento del pistone, l'altra veloce di ritorno - in dotazione 3 imbutoi ø 8 mm - 16,5 mm - 23,5 mm.
Optional: Serie imbutoi per insacchiatrici, 3 pezzi.
- EN** Stainless steel structure - aluminium piston - 2 speeds: a slow one for the piston advancement, a faster one to retract - supplied with 3 funnels ø 8 mm - 16,5 mm - 23,5 mm. Accessories: Funnels for sausage fillers, 3 pcs.
- FR** Corps en acier inox - piston en aluminium - 2 vitesses: lente pour faire avancer le piston, rapide pour son retour - de série 3 entonnoirs ø 8 mm - 16,5 mm - 23,5 mm.
Accessoires: Série d'entonnoirs pour poussoir à saucisse, 3 pièces.
- DE** Gehäuse aus Edelstahl - Aluminiumkolben - 2 Geschwindigkeiten, langsam für das Vorrücken des Kolbens, schnell für die Rückkehr - Ausstattung: 3 Trichter mit ø 8 mm - 16,5 mm - 23,5 mm.
Zubehör: Einfülltrichter-Satz, 3 Stück.
- ES** Estructura de acero inoxidable - pistón de aluminio - 2 velocidades, una lenta para el avance del pistón y otra veloz para su vuelta - en la dotación 3 embudos de ø 8 mm - 16,5 mm - 23,5 mm.
Accesorios: Serie de embudos para embutidoras, 3 unidades.
- RU** Корпус из нержавеющей стали - Алюминиевый поршень - 2 скорости, медленное поступательное движение и быстрый возврат поршня - Оснащение: 3 воронки с ø 8 мм - 16,5 мм - 23,5 мм.
Аксессуары: набор наполняющих воронок, 3 шт.



	LT7OR	LT7VE	LT14OR	LT14VE
	7 L ø 155 x 330(h) mm		14 L ø 196 x 485(h) mm	
	1200 x 400 x 400(h) mm	400 x 450 x 1050(h) mm	1550 x 450 x 450(h) mm	450 x 450 x 1400(h) mm
				
	18 Kg	26 Kg	27 Kg	36 Kg
	29 Kg	37 Kg	37 Kg	47 Kg
	800 x 350 x 480(h) mm		960 x 410 x 500(h) mm	
	0,134 m ³		0,197 m ³	

	IMBUTIINS
	ø 8 / 16,5 / 23,5 mm

PRESSAF10 PRESSAF13

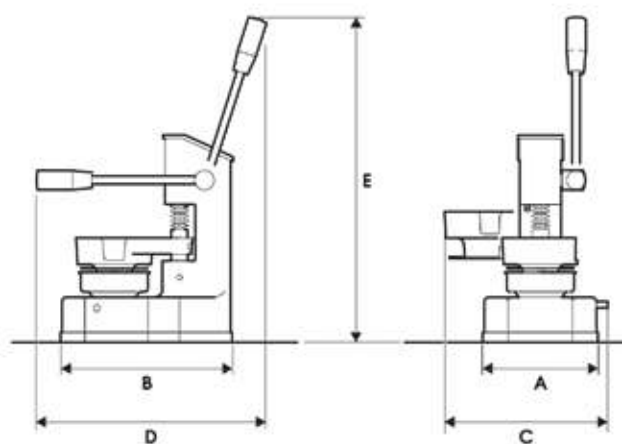



	∅ 100	∅ 130
A mm	175	175
B mm	260	260
C mm	250	275
D mm	370	420
E mm	500	530

Pressamburger

MANUAL HAMBURGER PRESS
PRESSE-HAMBURGER MANUELLE
MANUELLE HAMBURGERPRESSE
FORMADORA DE HAMBURGUESAS MANUAL
РУЧНОЙ ПРЕСС ДЛЯ ГАМБУРГЕРОВ

- IT Struttura in alluminio anodizzato - parti a contatto con la carne in acciaio inox.
PRESSAF10: hamburger ø 100 mm.
PRESSAF13: hamburger ø 130 mm.
- EN Anodised aluminium structure - parts in contact with meat made of stainless steel.
PRESSAF10: hamburger ø 100 mm.
PRESSAF13: hamburger ø 130 mm.
- FR Corps en aluminium anodisé - pièces en contact avec la viande en acier inox.
PRESSAF10: hamburger ø 100 mm.
PRESSAF13: hamburger ø 130 mm.
- DE Gehäuse aus Eloxalaluminium - fleischberührende Teile aus Edelstahl.
PRESSAF10: für Hamburger ø 100 mm.
PRESSAF13: für Hamburger ø 130 mm.
- ES Estructura de aluminio anodizado - partes en contacto con la carne de acero inoxidable.
PRESSAF10: para hamburguesa ø 100 mm.
PRESSAF13: para hamburguesa ø 130 mm.
- RU Корпус из анодированного алюминия - детали механизма для перемешивания мяса из нержавеющей стали.
PRESSAF10: Для гамбургеров ø 100 мм.
PRESSAF13: Para hamburguesa ø 130 мм.

	PRESSAF10	PRESSAF13
		
	370 x 250 x 500(h) mm	420 x 275 x 530(h) mm
		
	5 Kg	5,5 Kg
	6 Kg	7 Kg
	280 x 210 x 340(h) mm	
	0,020 m ³	

	ACCARTAF10	ACCARTAHF130
		
	Confezione di cellophan da 1 Kg - 1 Kg cellophan sheets 1 Kg feuilles de cellophane - 1 Kg zellophan Blätter Envase de celofán de 1 Kg - Целлофановая упаковка 1 Kr	
	ø 100 mm	ø 130 mm





Lavorazione Pasta

PASTA PROCESSING
TRAVAIL DE LA PATE
TEIGVERARBEITUNG
ELABORACIÓN PASTA
ПРИГОТОВЛЕНИЕ ТЕСТА

IT

Il capitolo della lavorazione della pasta è dedicato a tutti quei macchinari indispensabili per realizzare pasta fresca, dolci, pizza, piada, pane, grissini, taralli e tanto altro. Passando per la Macchina della Pasta Fresca completa di diversi tipi di trafilé, arriviamo al mondo delle Impastatrici a Spirale disponibili nella versione "Classic" ed "Evo" per incontrare le esigenze di tutti. Fimar negli ultimi anni si è specializzata nella progettazione di impastatrici specifiche sia per impasti ad alta idratazione come "Hydraplus", sia per quelli a bassa idratazione con "Berta" fornendo così una gamma completa. Non manca l'Impastatrice a Forcella, la gamma di Stendipizza, Sfogliatrici e la nuova Arrotondatrice. Completano il capitolo la linea di Planetarie dedicate al mondo della pasticceria.

EN

The pasta processing chapter is dedicated to all those machines that are indispensable for making fresh pasta, cakes, pizza, piada, bread, breadsticks, taralli and much more. Passing through the Fresh Pasta Machine complete with different types of dies, we arrive at the world of Spiral Kneaders available in the 'Classic' and 'Evo' versions to meet everyone's needs. In recent years Fimar has specialised in the design of specific mixers for both high hydration doughs such as 'Hydraplus' and low hydration doughs with 'Berta', thus providing a complete range. There are also fork kneaders, a range of pizza rollers, dough rollers and the new dough rounder. A line of Planetary Mixers dedicated to the world of pastry making completes the chapter.

FR

Le chapitre consacré au travail des pâtes est dédié à toutes les machines indispensables à la fabrication de pâtes fraîches, de gâteaux, de pizzas, de piada, de pains, de gressins, de taralli et plus encore. En passant par la machine à pâtes fraîches équipée de différents types de filières, nous arrivons au monde des pétrins à spirale, disponibles dans les versions « Classic » et « Evo » pour répondre aux besoins de chacun. Ces dernières années, Fimar s'est spécialisé dans la conception de pétrins spécifiques pour les pâtes à forte hydratation comme « Hydraplus » et pour les pâtes à faible hydratation comme « Berta », offrant ainsi une gamme complète. Il y a aussi le pétrin à fourche, la gamme de façonneuse à pizza, les façonneuse à pâte et la nouvelle machine à arrondir. Une ligne de mélangeurs planétaires dédiés au monde de la pâtisserie complète le chapitre.

DE

Die Sektion Teigwarenverarbeitung stellt alle Maschinen vor, die für die Herstellung von frischen Nudeln, Kuchen, Pizzas, Piadas, Brot, Stangen, Taralli und vielem mehr unverzichtbar sind. Nach einer Maschine für frische Pasta, die mit verschiedenen Formen ausgestattet ist, betreten wir die Welt der Spiral-Teigknetmaschinen, die in den Versionen „Classic“ und „Evo“ erhältlich sind, um allen Anforderungen gerecht zu werden. In den letzten Jahren hat sich Fimar auf die Entwicklung spezieller Teigknetter für Teige mit hohem Feuchtigkeitsgehalt, wie den „Hydraplus“, und für Teige mit niedrigem Feuchtigkeitsgehalt, wie den „Berta“, spezialisiert und bietet somit eine vollständige Produktpalette. Außerdem gibt es einen Gabelknetter, eine Reihe von Pizza-Ausrollmaschinen, Teigausrollmaschine und einen neuen Teigabrunder. Abgerundet wird das Angebot durch eine Reihe von Planetenmischern für die Konditorei.

ES

El capítulo dedicado a la elaboración de pasta presenta todas las máquinas indispensables para hacer pasta fresca, pasteles, pizzas, piadas, pan, grissines, taralli y mucho más. Pasando por la máquina para pasta fresca equipada con diferentes tipos de moldes, entramos en el mundo de las amasadoras de espiral, disponibles en las versiones «Classic» y «Evo» para satisfacer cualquier necesidad. En los últimos años, Fimar se ha especializado en el desarrollo de amasadoras especiales tanto para masas de alta hidratación, como la «Hydraplus», como para masas de baja hidratación, como la «Berta», ofreciendo así una gama completa. También hay amasadora de horquilla, una gama de máquinas para extender pizzas, máquinas para extender pasta y la nueva boleadora. Completa la sección una gama de amasadoras planetarias diseñadas para la producción de confitería.

RU

В разделе «Обработка макаронных изделий» представлены все те машины, которые незаменимы для приготовления свежей пасты, пирожных, пиццы, пиады, хлеба, хлебных палочек, таралли и многого другого. Пройдя через машину для приготовления свежей пасты, оснащенную различными видами фильер, мы попадаем в мир спиральных тестомесов, доступных в версиях «Classic» и «Evo», чтобы удовлетворить любые потребности. В последние годы Fimar специализируется на разработке специальных тестомесов как для теста с высокой гидратацией, например «Hydraplus», так и для теста с низкой гидратацией, например «Berta», таким образом, обеспечивая полный ассортимент.

PF15E
PF25E



PF15E



PF25E



GUARDA IL VIDEO
WATCH THE VIDEO



LEGGI IL RICETTARIO
READ THE RECIPEBOOK

Macchina pasta fresca

PASTA MACHINE
MACHINE À PÂTE
NUDELMASCHINE
MÁQUINA PARA PASTA FRESCA
МАШИНКА ДЛЯ ПРИГОТОВЛЕНИЯ
СВЕЖИХ МАКАРОННЫХ ИЗДЕЛИЙ

IT Macchina per la pasta fresca "Lilly" ideale per impastare ed estrarre impasti in diversi formati. Utensile impastatore ed elica in acciaio inox AISI 304 - microinterruttore di sicurezza su coperchio vasca - coperchio con feritoie (PF15E) - coperchio grigliato (PF25E) per permettere l'inserimento di ingredienti anche durante la lavorazione - pannello di comandi digitale - vasca completamente estraibile per un facile e rapido lavaggio. Accessori: trafile in bronzo di diverso tipo, coltello tagliapasta, carrello, cavalletto e cassette porta pasta fresca.

EN "Lilly" fresh pasta machine ideal for kneading and extruding dough in different shapes. Kneading tool and propeller in stainless steel AISI 304 - safety microswitch on bowl lid - lid with slits (PF15E) - grilled lid (PF25E) to allow ingredients to be inserted even during processing - digital control panel - fully extractable bowl for easy and quick washing. Accessories: bronze moulds of various types, pasta-cutting knife, trolley, stand and fresh pasta trays.

FR Machine à pâtes fraîches "Lilly" idéale pour pétrir et extruder des pâtes de différentes formes. Pétrin et hélice en acier inox AISI 304 - micro-interrupteur de sécurité sur le couvercle de la cuve - couvercle avec fentes (PF15E) - couvercle grillagé (PF25E) pour permettre l'introduction des ingrédients même pendant le travail - panneau de contrôle digital - cuve entièrement extractible pour un lavage facile et rapide. Accessoires: tréfileuses en bronze de différents types, couteau pour couper les pâtes, chariot, support et boîtes pour pâtes fraîches.

DE Die Frischnudelmaschine "Lilly" ist ideal zum Kneten und Extrudieren von Teig in verschiedenen Formen. Knetwerkzeug und Propeller aus Edelstahl AISI 304 - Sicherheitsmikroschalter auf dem Schüsseldeckel - Deckel mit Einwurfschlitz (PF15E) - gegrillter Deckel (PF25E), um das Einfüllen von Zutaten auch während der Verarbeitung zu ermöglichen - digitales Bedienfeld - vollständig herausnehmbare Schüssel für eine einfache und schnelle Reinigung. Zubehör: verschiedene Nudleinsätze, Nudelschneidmesser, Wagen, Ständer und Behälter für frische Nudeln.

ES Máquina para pasta fresca "Lilly" ideal para amasar y extrudir masas de diferentes formas. Herramienta de amasado y hélice de acero inoxidable AISI 304 - microinterruptor de seguridad en la tapa de la cuba - tapa con ranuras (PF15E) - tapa con rejilla (PF25E) para poder introducir ingredientes incluso durante la elaboración - panel de control digital - cuba totalmente extraíble para un lavado fácil y rápido. Accesorios: moldes de bronce de varios tipos, cuchillo cortapastas, carro, soporte y cajas para pasta fresca.

RU Машина для приготовления свежей пасты "Lilly" идеально подходит для замешивания и выдавливания теста различных форм. Месильный инструмент и пропеллер из нержавеющей стали AISI 304 - предохранительный микровыключатель на крышке чаши - крышка с прорезями (PF15E) - крышка-гриль (PF25E), позволяющая вставлять ингредиенты даже во время обработки - цифровая панель управления - полностью извлекаемая чаша для легкого и быстрого мытья. Аксессуары: Фильера из бронзы различных типов, нож для нарезки макарон, тележка, подставка и коробки для свежих макарон.

	PF15E	PF25E
	0,25 kW (0,33 HP)	0,37 kW (0,5 HP)
	-	230-400V/3N/50Hz
	230V/1N/50Hz	
	2 L	4 L
	2,5 ÷ 5 Kg/h	8 Kg/h
	1,5 Kg	2 Kg
	ø 50 mm*	ø 57 mm*
	239 x 512 x 317÷454(h) mm	306 x 536 x 416÷536(h) mm
		
	16 Kg	27 Kg
	19 Kg	34 Kg
	280 x 520 x 450(h) mm	390 x 650 x 560(h) mm
	0,065 m³	0,141 m³

Special Voltages - Разное питающее напряжение

* Trafile escluse - Without mould - Filières exclues
Nudleinsätze ausgeschlossen - Moldes no incluidos - Фильера исключен

PF40E
PF80E



Made in
Romagna



MADE IN ITALY



PF40E
CON COLTELLO DI SERIE
WITH KNIFE INCLUDED



GUARDA IL VIDEO
WATCH THE VIDEO



LEGGI IL RICETTARIO
READ THE RECIPEBOOK



PF80E
CON COLTELLO E CAVALLETTO DI SERIE
WITH KNIFE AND STAND INCLUDED

Macchina pasta fresca

PASTA MACHINE
MACHINE À PÂTE
NUDELMASCHINE
MÁQUINA PARA PASTA FRESCA
МАШИНКА ДЛЯ ПРИГОТОВЛЕНИЯ
СВЕЖИХ МАКАРОННЫХ ИЗДЕЛИЙ

IT Macchina per la pasta fresca "Lilly" ideale per impastare ed estrarre impasti in diversi formati. Carcassa, vasca, supporto vasca, gancio impastatore ed elica in acciaio inox AISI 304 - microinterruttore su coperchio vasca - coperchio grigliato per permettere l'inserimento di ingredienti anche durante la lavorazione - pannello di comandi digitale - vasca completamente estraibile per un facile e rapido lavaggio - bocca di estrusione con raffreddamento ad acqua - coltello taglia pasta incluso - cavalletto incluso solo per modello PF80E (cod. ACCAVPF80EN0). Accessori: trafilè in bronzo di diverso tipo, carrello e cassette porta pasta fresca.

EN "Lilly" fresh pasta machine ideal for kneading and extruding dough in different shapes. Casing, bowl, bowl support, kneading hook and propeller in stainless steel AISI 304 - microswitch on bowl lid - grilled lid to allow the addition of ingredients even during processing - digital control panel - fully extractable bowl for easy and quick washing - extrusion nozzle with water cooling - pasta cutter included - stand included only for model PF80E (cod. ACCAVPF80EN0). Accessories: bronze moulds in different shapes, trolley and fresh pasta trays.

FR Machine à pâtes fraîches "Lilly" idéale pour pétrir et extruder des pâtes de différentes formes. Corps, cuve, support cuve, crochet pétrisseur et hélice en acier inox AISI 304 - micro-interrupteur sur le couvercle de la cuve - couvercle grillagé pour permettre l'insertion des ingrédients même pendant le travail - panneau de contrôle digital - cuve entièrement extractible pour un lavage facile et rapide - orifice d'extrusion avec refroidissement par eau - couteau coupe-pâte inclus - support inclus seulement pour le modèle PF80E (code ACCAVPF80EN0). Accessoires: tréfileuses en bronze de différents types, couteau pour couper les pâtes, chariot et boîtes pour pâtes fraîches.

DE Die Frischnudelmaschine "Lilly" ist ideal zum Kneten und Extrudieren von Teig in verschiedenen Formen. Gehäuse, Schüssel, Schüsselhalterung, Knethaken und Propeller aus Edelstahl AISI 304 - Mikroschalter am Schüsseldeckel - ge grillter Deckel, um das Einfüllen von Zutaten auch während der Verarbeitung zu ermöglichen - digitales Bedienfeld - vollständig herausnehmbare Schüssel für einfaches und schnelles Waschen - Mundstück mit Wasserkühlung - Teigschneidmesser im Lieferumfang enthalten - Ständer nur für das Modell PF80E (Code ACCAVPF80EN0) enthalten. Zubehör: verschiedene Nudleinsätze, Nudelschneidmesser, Wagen, Ständer und Behälter für frische Nudeln.

ES Máquina para pasta fresca "Lilly" ideal para amasar y extrudir masas de diferentes formas. Carcasa, cuba, soporte de cuba, gancho amasador y hélice de acero inoxidable AISI 304 - microinterruptor en la tapa de la cuba - tapa con rejilla para permitir la introducción de ingredientes incluso durante la elaboración - panel de control digital - cuba totalmente extraíble para un lavado fácil y rápido - boca de extrusión con raffcooling de agua - cuchillo cortapastas incluido - soporte incluido solo para el modelo PF80E (cod. ACCAVPF80EN0). Accesorios: moldes de bronce de varios tipos, carro y cajas para pasta fresca.

RU Машина для приготовления свежей пасты "Lilly" идеально подходит для замешивания и выдавливания теста различных форм. Корпус, опора чаши, крюк для замешивания и пропеллер из нержавеющей стали AISI 304 - микровыключатель на крышке чаши - крышка с грилем, позволяющая закладывать ингредиенты даже во время обработки - цифровая панель управления - полностью извлекаемая чаша для легкого и быстрого мытья - экструзионная горловина с водяным охлаждением - нож для резки макаронных изделий в комплекте - подставка в комплекте только для модели PF80E (код ACCAVPF80EN0). Аксессуары: бронзовые лотки различных типов, тележка и коробки для свежих макарон.

	PF40E	PF80E
	0,75 kW (1 HP)	1,5 kW (2 HP)
	230-400V/3N/50Hz	
	230V/1N/50Hz	-
	6 L	9 L
	13 Kg/h	20 Kg/h
	3,5 Kg	7,5 Kg
	ø 57 mm*	ø 78 mm*
	no	si / yes
	320 x 582 x 525÷630(h) mm	396/537 x 717 x 637÷796(h) mm
		
	35 Kg	76 Kg
	46 Kg	105 Kg
	460 x 700 x 770(h) mm	550 x 855 x 1070(h) mm
	0,250 m³	0,500 m³

Special Voltages - Разное питающее напряжение

* Trafile escluse - Without mould - Filières exclues
Nudleinsätze ausgeschlossen - Moldes no incluidos - Фильера исключен

MPF15N
MPF25N
MPF25CN



MPF15N



MPF25N



MPF25CN

Macchina pasta fresca

PASTA MACHINE
MACHINE À PÂTE
NUDELMASCHINE
MÁQUINA PARA PASTA FRESCA
МАШИНКА ДЛЯ ПРИГОТОВЛЕНИЯ
СВЕЖИХ МАКАРОННЫХ ИЗДЕЛИЙ

IT Macchina per impastare ed estrarre impasti all'uovo in diversi formati. Struttura rivestita con vernice antigraffio - vasca, gancio impastatore ed elica in acciaio inox AISI 304 - microinterruttore su coperchio vasca. Il modello MPF25CN include il coltello taglia pasta elettronico nel prezzo. Accessori: trafile in bronzo di diverso tipo - carrello e cassette porta pasta fresca.













EN Machine to mix and mould egg mixtures pasta in different shapes. Structure coated with scratch-proof paint - AISI 304 stainless steel bowl, blade and kneader - micro switch on basin lid. The price of MPF25CN model includes the electronic pasta cutter knife. Accessories: bronze moulds in different shapes - trolley and fresh pasta containers.

FR Machine pour pétrir et extruder la pâte aux oeufs en différents formats. Corps recouvert de peinture anti-rayures - cuve, hélice et crochet pétrisseur en acier inox AISI 304 - microinterrupteur sur le couvercle de la cuve. Le prix du modèle MPF25CN inclut le couteau coupe-pâtes électronique. Accessoires: filières en bronze de différents types - chariot et bacs de pâtes fraîches.

DE Knet- und Extrudiermaschine für Eimischungen in verschiedenen Formaten. Gehäuse mit kratzfester Lackierung beschichtet - Schüssel, Spirale und Knethaken aus Edelstahl AISI 304 - Mikroschalter am Behälterdeckel. Beim Modell MPF25CN ist das elektronische Nudelschneidemesser im Preis inbegriffen. Zubehör: verschiedene Arten von Nudleinsätze - Wagen und Behälter für frische Nudeln.

ES Máquina para amasar y extrudir masas con huevo de diferentes formatos. Estructura recubierta con pintura anti-arañazos - bol y hélice de aleación, gancho amasador de acero inoxidable AISI 304 - microinterruptor en la tapa del bol. Con el modelo MPF25CN se incluye en el precio el cuchillo electrónico para cortar pasta. Accesorios: moldes de bronce de diferentes tipos, carro y cajas para pasta fresca.

RU Тестомес-экструдер для яичных смесей различных форматов. Корпус покрыт устойчивой к царапинам краской - дежа и месильный крюк из нержавеющей стали AISI 304 - микровыключатель на крышке контейнера. В модели MPF25CN электронный нож для макаронных изделий включен в цену. Принадлежности: Вставки для лапши различных форм - тележка и коробки со свежими макаронами. Принадлежности: Вставки для лапши различных форм - тележка и коробки со свежими макаронами.

	MPF15N	MPF25N	MPF25CN
			
	0,3 kW (0,4 HP)	0,37 kW (0,5 HP)	
	230V/1N/50Hz		
	5 Kg/h	8 Kg/h	
	1,5 Kg	2,5 Kg	
	ø 50 mm*	ø 57 mm*	
	250 x 480 x 290÷460(h) mm	260 x 600 x 380÷560(h) mm	
			
	18 Kg	30 Kg	32 Kg
	20 Kg	36 Kg	38 Kg
	320 x 590 x 410(h) mm	360 x 710 x 560(h) mm	370 x 720 x 580(h) mm
	0,077 m³	0,140 m³	0,155 m³

Special Voltages - Разное питающее напряжение

* Trafile escluse - Without mould - Filières exclues
Nudleinsätze ausgeschlossen - Moldes no incluidos - Фильера исключен

MPF4N
MPF8N



MPF4N
CON COLTELLO DI SERIE
WITH KNIFE INCLUDED



MPF8N
CON COLTELLO E CAVALLETTO DI SERIE
WITH KNIFE AND STAND INCLUDED

Macchina pasta fresca

PASTA MACHINE
MACHINE À PÂTE
NUDELMASCHINE
MÁQUINA PARA PASTA FRESCA
МАШИНКА ДЛЯ ПРИГОТОВЛЕНИЯ
СВЕЖИХ МАКАРОННЫХ ИЗДЕЛИЙ

IT Macchina per impastare ed estrarre impasti all'uovo in diversi formati. Struttura rivestita con vernice antigraffio - vasca, gancio impastatore ed elica in acciaio inox AISI 304 - elica in lega ottone/bronzo (MPF8N) - microinterruttore su coperchio vasca - raffreddamento della zona di estrusione ad aria - coltello taglia pasta elettronico di serie. Il modello MPF8N ha il cavalletto di serie. Accessori: trafilare in bronzo di diverso tipo - carrello e cassette porta pasta fresca.

EN Machine to mix and mould egg mixtures in different shapes. Structure coated with scratch-proof paint - AISI 304 stainless steel bowl, blade and kneader - brass/bronze alloy blade (MPF8N) - micro switch on bowl lid - air-cooled extrusion area - electronic pasta cutter knife as standard. Model MPF8N is delivered with stand as standard. Accessories: bronze moulds in different shapes - trolley and fresh pasta containers.

FR Machine pour pétrir et extruder la pâte aux oeufs en différents formats. Corps recouvert de peinture anti-rayures - cuve, hélice et crochet pétrisseur en acier inox AISI 304 - hélice en alliage laiton/bronze (MPF8N) - microinterrupteur sur le couvercle de la cuve - refroidissement de la partie d'extrusion à l'air et coupe-pâtes électronique de série. Le modèle MPF8N inclut de série le support. Accessoires: filières en bronze de différents types - chariot et bacs de pâtes fraîches.

DE Knet- und Extrudiermaschine für Eismischungen in verschiedenen Formaten. Gehäuse mit kratzfester Lackierung beschichtet - Wanne, Spirale aus Messing und Kneethaken aus Edelstahl AISI 304 - Spirale aus Messing und Bronzelegierung (MPF8N) - Mikroschalter am Wannendeckel. Serienausstattung: Luftkühlung des Extrusionsbereichs und elektronischer Nudelschneider. Das Modell MPF8N ist serienmäßig mit einem Stützfuß ausgestattet. Zubehör: verschiedene Arten von Nudleinsätze - Wagen und Behälter für frische Nudeln.







ES Máquina para amasar y extrudir masas con huevo de diferentes formatos. Estructura recubierta con pintura anti-arañazos - bol y gancho amasador de acero inoxidable AISI 304 - hélice de aleación latón/bronze (MPF8N) - microinterrupción en la tapa del bol. Refrigeración de la zona de extrusión por aire. Corta pasta electrónico en la dotación. Con el modelo MPF8N se incluye también el trípode. Accesorios: moldes de bronce de diferentes tipos, carro y cajas para pasta fresca.

RU Тестомес-экструдер для яичных смесей различных форматов. Корпус покрыт устойчивой к царапинам краской - дежа и месильный крюк из нержавеющей стали AISI 304 - спирали из латуни и бронзового сплава (MPF8N) - микровыключатель на крышке контейнера. Стандартное оснащение: воздушное охлаждение зоны экструзии и электронный нож для макаронных изделий. Модель MPF8N оснащена опорной ножкой. Принадлежности: Вставки для лапши различных форм - тележка и коробки со свежими макаронами.

* Trafile escluse - Without mould - Filières exclues
Nudleinsätze ausgeschlossen - Moldes no incluidos - Фильера исключен

	MPF4N	MPF8N
	0,75 kW (1 HP)	1 kW (1,3 HP)
	230-400V/3/50Hz	
		
	13 Kg/h	25 Kg/h
	4 Kg	8 Kg
	ø 57 mm*	ø 78 mm*
	no	si / yes
	350 x 760 x 450÷640(h) mm	450 x 720 x 750÷990(h) mm
		
	42 Kg	87 Kg
	51 Kg	97 Kg
	460 x 740 x 670(h) mm	800 x 1000 x 940(h) mm
	0,228 m ³	0,524 m ³

Special Voltages - Разное питающее напряжение

	ACCARMPF	
	580 x 440 x 560(h) mm	
	12,2 Kg	 13,6 Kg
	640 x 430 x 610(h) mm	 0,168 m ³

Optional

ACCESSORIES
ACCESSOIRES
ZUBEHÖR
ACCESORIOS
AKCECCYAPЫ

TRAFILE

FORMATI VARI IN LEGA OTTONE-BRONZO

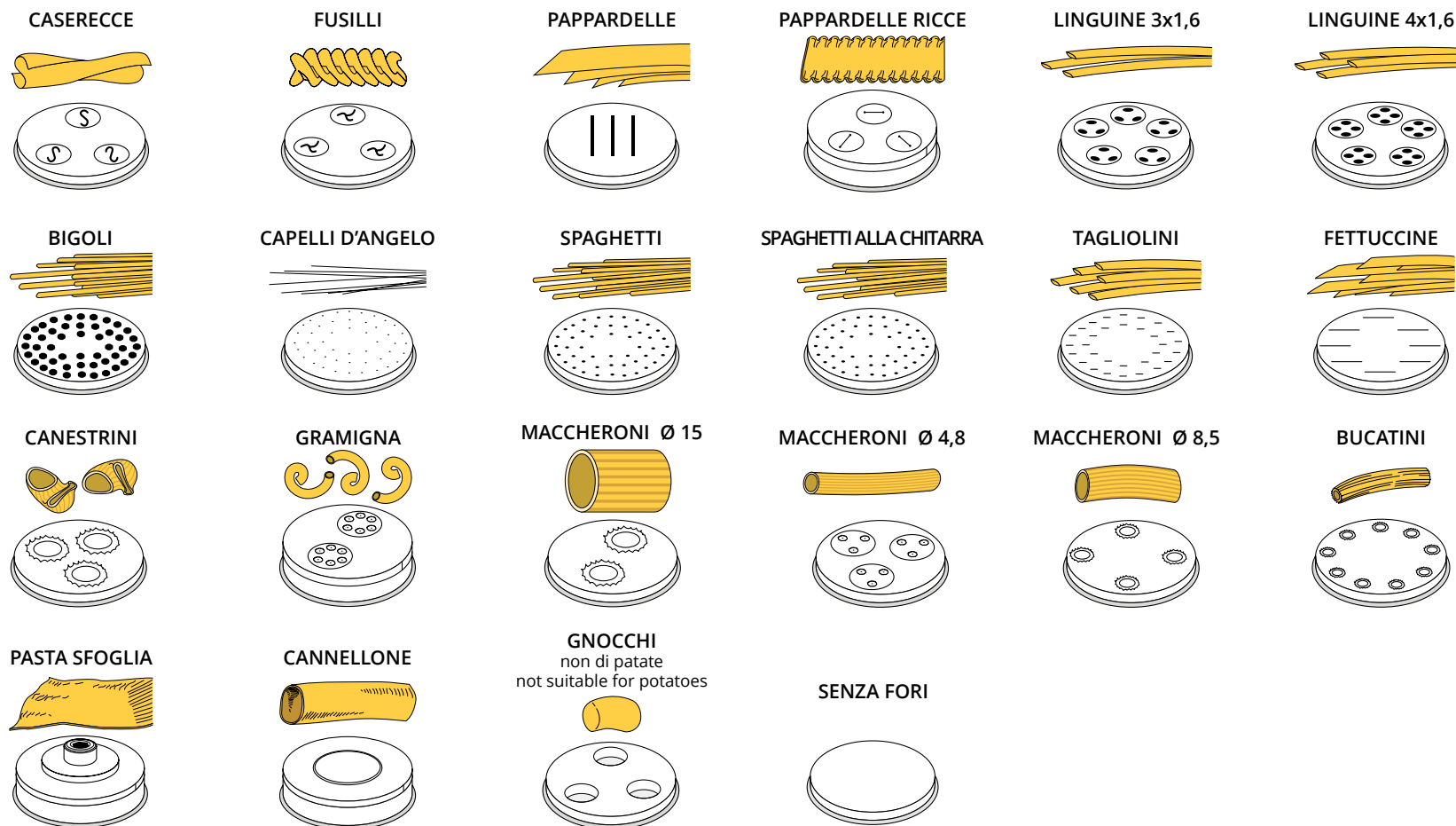

I disegni delle trafile sono indicativi.
Il numero dei fori cambia in base
al modello della macchina.

The drawings of the moulds are merely
illustrative. The number of holes changes
depending on the machine model.

Les dessins des filières sont donnés à
titre indicatif. Le nombre de trous varie
en fonction du modèle de la machine.

Die Abbildungen der Einsätze sind nur
als Beispiel zu verstehen. Die Anzahl der
Löcher ändert sich je nach Maschinentyp.

Los gráficos de las moldes son indicativos.
El número de agujeros varía según
el modelo de la máquina.

Рисунки вставок следует рассматривать
только в качестве примера.
Число отверстий зависит от типа станка.



IT Trafile formati vari in lega ottone-bronzo.

EN Brass-bronze alloy mould in different shapes.

FR Filières d'étrirage de différentes tailles en alliage laiton-bronze.

DE Nudeteile in verschiedenen Formate aus Messing-Kupferlegierung.

ES Moldes de diferentes medidas y tamaños en aleación de latón-bronze.

RU Насадки для макаронных изделий для различных форматов из латуно-бронзового сплава.

Mod.	PF15E - MPF15N	PF25E - MPF25N	PF40E - MPF4N	PF80E - MPF8N
CASERECCE - 9 x 5 mm	ACTRMPF13		ACTRMPF1	ACTRMPF25
FUSILLI - ø 9 mm	ACTRMPF17		ACTRMPF2	ACTRMPF29
PAPPADELLE - 16 mm	ACTRMPF18		ACTRMPF3	ACTRMPF30
GNOCCHI - ø 12 mm	ACTRMPF19		ACTRMPF4	ACTRMPF31
BUCATINI - ø 4 mm	ACTRMPF20		ACTRMPF5	ACTRMPF32
BIGOLI - ø 3 mm	ACTRMPF43		ACTRMPF41	ACTRMPF44
CAPELLI D'ANGELO - ø 1 mm	ACTRMPF22		ACTRMPF7	ACTRMPF34
SPAGHETTI - ø 2 mm	ACTRMPF23		ACTRMPF8	ACTRMPF35
SPAGHETTI ALLA CHITARRA 2 x 2 mm	ACTRMPF39		ACTRMPF40	ACTRMPF38
TAGLIOLINI - 3 mm	ACTRMPF24		ACTRMPF9	ACTRMPF36
FETTUCCINE - 8 mm	ACTRMPF14		ACTRMPF10	ACTRMPF26
MACCHERONI - ø 8,5 mm	ACTRMPF21		ACTRMPF6	ACTRMPF33
CANNELLONE RIPIENO	ACTRMPF16 ø 25 mm		ACTRMPF12 ø 25 mm	ACTRMPF28 ø 30 mm
SENZA FORI	ACTRMPF42		ACTRMPF37	ACTRMPF45

LINGUINE 3 x 1.6 - 3 mm	ACTRMPF49		ACTRMPF50	ACTRMPF51
LINGUINE 4 x 1.6 - 4 mm	ACTRMPF52		ACTRMPF53	ACTRMPF54
GRAMIGNA - ø 3,5 mm	ACTRMPF55		ACTRMPF56	ACTRMPF57
PAPPADELLE RICCE - 16 mm	ACTRMPF46		ACTRMPF47	ACTRMPF48
MACCHERONI - ø 4,8 mm	ACTRMPF64		ACTRMPF65	ACTRMPF66
MACCHERONI - ø 15 mm	ACTRMPF67		ACTRMPF68	ACTRMPF69
CANESTRINI - ø 16 mm	ACTRMPF70		ACTRMPF71	ACTRMPF72

PASTA SFOGLIA min. 1 - max 4 mm spessore/thickness	ACTRMPF15 135 mm		ACTRMPF11 155 mm	ACTRMPF27 205 mm
--	---------------------	--	---------------------	---------------------

CARPF



Carrello in acciaio inox per macchine della pasta fresca PF25E e PF40E, con possibilità di portare fino ad 8 cassette per la pasta fresca di altezza 7 cm (AV6007N) - 4 ruote di cui 2 con freno - cassette escluse.

Stainless steel trolley for fresh pasta machines PF25E and PF40E, suitable for the storage of up to 8 fresh pasta trays 7 cm high (AV6007N) - 4 wheels, 2 with brakes - trays not included.

Chariot en acier inox pour machines à pâtes fraîches PF25E et PF40E, avec possibilité de transporter jusqu'à 8 boîtes de pâtes fraîches de 7 cm de hauteur (AV6007N) - 4 roues, dont 2 avec frein - boîtes non incluses.

Wagen aus Edelstahl für die Frischnudelmaschinen PF25E und PF40E, mit der Möglichkeit, bis zu 8 Frischnudelbehälter von 7 cm Höhe zu fördern (AV6007N) - 4 Räder, davon 2 mit Bremse - Behälter nicht enthalten.

Carro de acero inoxidable para máquinas de pasta fresca PF25E y PF40E, con posibilidad de transportar hasta 8 cajas de pasta fresca de 7 cm de altura (AV6007N) - 4 ruedas, 2 de ellas con freno - cajas no incluidas.





Тележка из нержавеющей стали для машин для свежих макарон PF25E и PF40E, с возможностью перевозки до 8 коробок свежих макарон высотой 7 см (AV6007N) - 4 колеса, 2 из которых с тормозом - коробки в комплект не входят.

AV6007N



AV6007N

AV6007N	
	Cassetta porta pasta fresca - Fresh pasta container Bac à pâtes fraîches - Frische Nudeln Behälter Caja para pasta fresca - Коробка со свежими макаронами
 mm	600 x 400 x 70(h) mm

CARPF	
 mm	735/1035 x 520 x 940(h) mm
 mm	350 x 445 mm
 NET Kg	17,5 Kg
 GROSS Kg	20,5 Kg
 mm	900 x 800 x 150(h) mm
 m ³	0,108 m ³

ACCOLPF15N1 ACCOLPFN1



ACCOLPF15N1

Coltello tagliapasta per macchine pasta fresca con lama singola e doppia facilmente intercambiabili.

Pasta cutter knife for fresh pasta machines with easily interchangeable single and double blade.

Couteau coupe-pâtes pour machines à pâtes fraîches avec lame simple ou double facilement interchangeable.

Nudelschneidemesser für Frischnudelmashinen mit leicht auswechselbarer Einzel- und Doppelklinge.

Cuchillo cortapastas para máquinas de pasta fresca con hoja simple y doble fácilmente intercambiables.

Нож для резки макаронных изделий для машин для изготовления свежей пасты с легко заменяемым одинарным и двойным лезвием.

ACCAVPF80ENO



ACCAVPF80ENO

	ACCOLPF15N1	ACCOLPFN1
Mod.	PF15E	PF25E PF40E (incluso/included)
	230V/50-60Hz	
 RPM	7-70 rpm	
 mm	ø120 x 223(h) mm	ø120 x 232(h) mm
 NET Kg	2 Kg	2,4 Kg
 GROSS Kg	3 Kg	3,4 Kg
 mm	210 x 160 x 310(h) mm	
 m³	0,0104 m³	

	ACCAVPF80ENO
	Cavalletto in lamiera verniciata di colore bianco Stand in white painted metal sheet - Support en tôle peinte en blanc Ständer aus weiß lackiertem Blech - Soporte de chapa pintada en blanco Подставка из окрашенного в белый цвет листового металла
Mod.	PF80E (incluso/included)
 mm	758 x 469 x 607(h) mm
 NET Kg	15 Kg
 GROSS Kg	18 Kg
 mm	850 x 500 x 100(h) mm
 m³	0,425 m³

OPTIONAL

PF15E

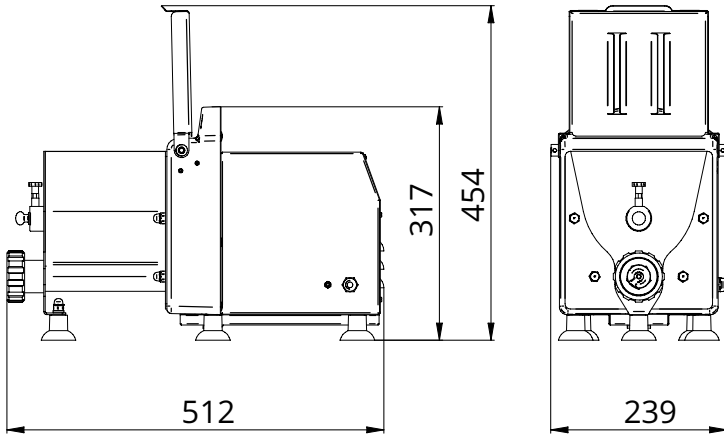

PF25E

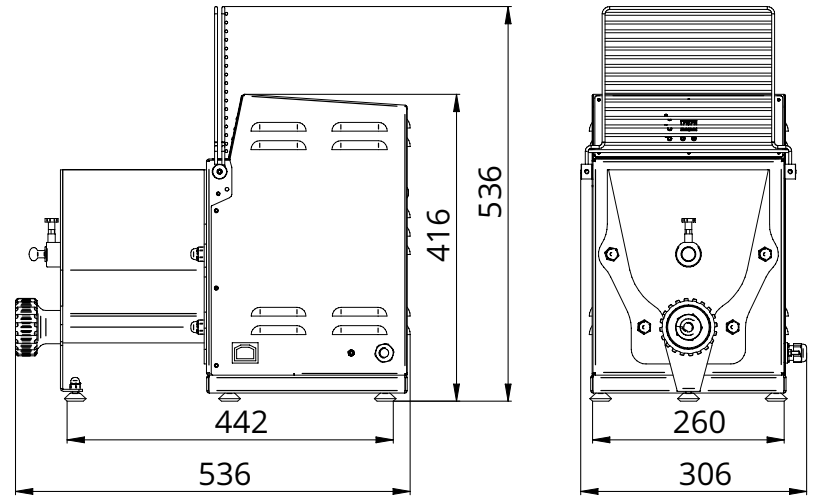

PF40E

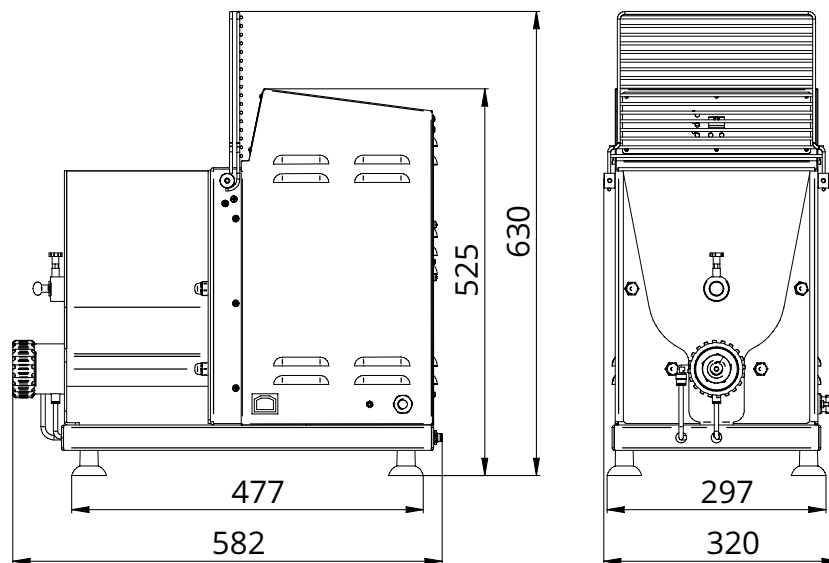

PF80E

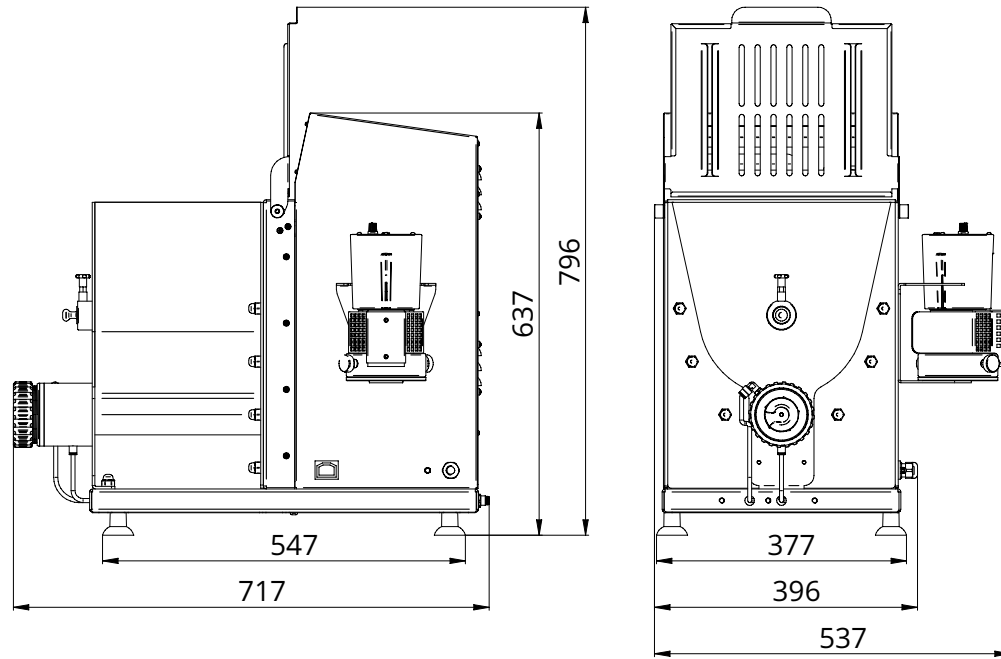

PF80E + ACCOLPF80N + ACCAVPF80EN0

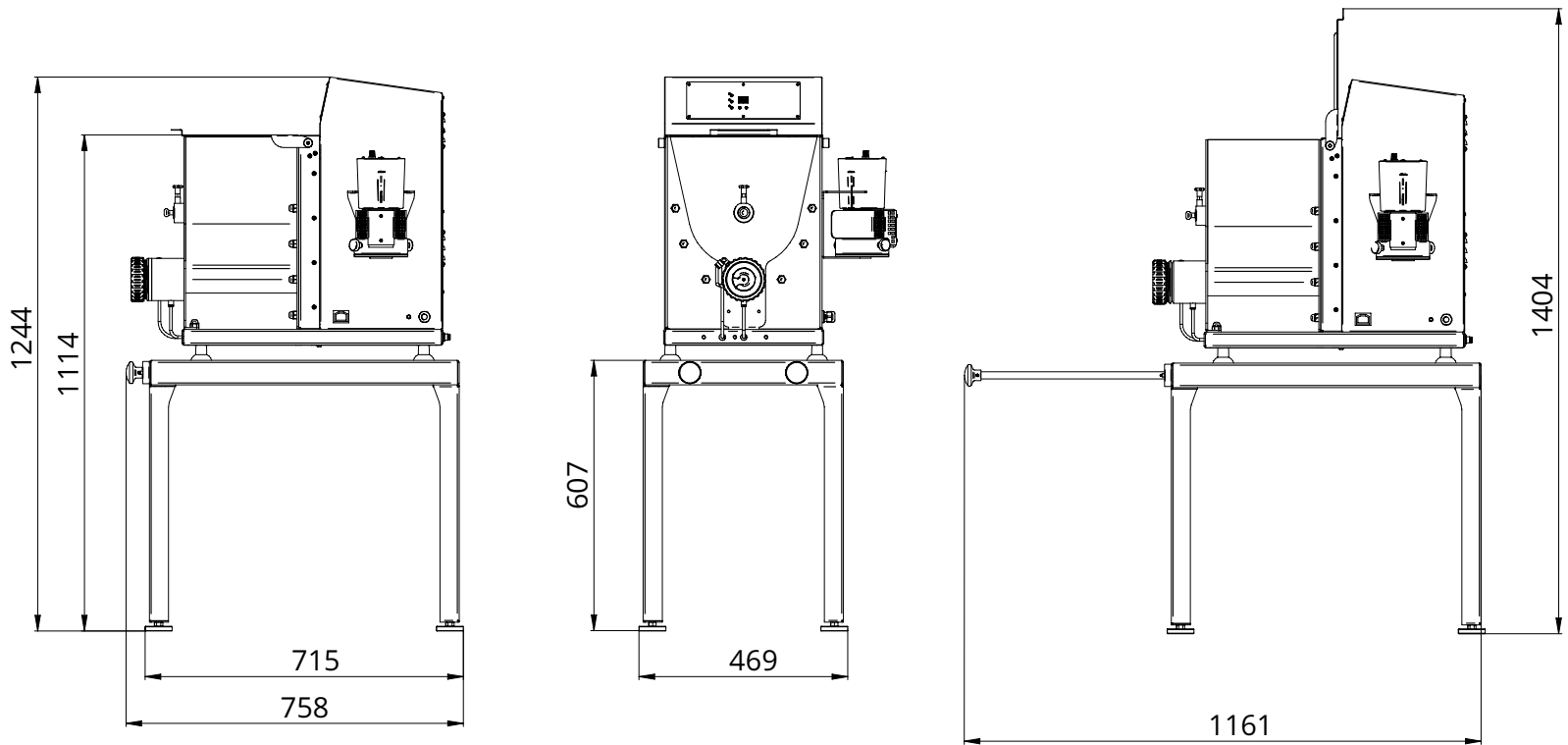

IMPASTATRICI A SPIRALE



Ideale per impasti ad alta idratazione
Variatore di velocità 55÷250 rpm
Pannello comandi in alto



Ideale per impasti ad idratazione standard
Una o due velocità
Pannello comandi in alto

fimar
group



Specially suitable for high-hydration doughs
Speed variator 55÷250 rpm
Control panel at the top



Specially suitable
for standard-hydration doughs
1 or 2 speed
Control panel at the top



**ALTA IDRATAZIONE DELL'IMPASTO
HIGH HYDRATION OF THE DOUGH**

SPIRAL KNEADER

Classic

Ideale per impasti ad idratazione standard
Una o due velocità
Pannello comandi laterale



Specially suitable
for standard-hydration doughs
1 or 2 speed
Side control panel

Light

Ideale per impasti ad idratazione standard
Una o due velocità
Pannello comandi laterale
Solo con testa e vasca fissa



Specially suitable
for standard-hydration doughs
1 or 2 speed
Side control panel
Only with fixed head and bowl

Berta[®]

Ideale per impasti a bassa idratazione
Ottimi risultati per impasti all'uovo
Una o due velocità
Pannello comandi in alto
Solo con vasca fissa



Specially suitable for low-hydration doughs
Also suitable for egg mixtures
1 or 2 speed
Control panel at the top
Only with fixed bowl



**BASSA IDRATAZIONE DELL'IMPASTO
LOW HYDRATION OF THE DOUGH**

12CNSO-18CNSO
25CNSO-38CNSO
50CNSO



Impastatrice a spirale
con testa sollevabile e vasca estraibile

SPIRAL KNEADER
PETRIN A SPIRAL
SPIRALTEIGKNETMASCHINE
AMASADORA DE ESPIRAL
СПИРАЛЬНЫЙ ТЕСТОМЕС

IT Impastatrice a spirale con testa sollevabile e vasca estraibile.
Macchina per realizzare diversi tipi di impasto, indicata soprattutto per impasti teneri come pane, pizza e piada. Struttura rivestita con vernice antigraffio - parti a contatto con gli alimenti quali vasca, spirale ed asta spacca pasta sono in acciaio inox - microinterruttore di sicurezza su coperchio vasca. Coperchio in policarbonato fumè di serie tranne per il mod. 50CNS0 disponibile solo con coperchio grigliato in acciaio inox AISI 304. Vari optional a richiesta.

FR Pétrin à spirale avec tête relevable et cuve amovible.
Machine pour le pétrissage de différents types de pâte, particulièrement adaptée aux pâtes tendres telles que le pain, la pizza et la piadina. Structure recouverte de peinture anti-rayures - les parties en contact avec les aliments telles que la cuve, la spirale et la brise-pâte sont en acier inox - microrupteur de sécurité sur le couvercle de la cuve. Couvercle en polycarbonate fumé en standard sauf pour le mod. 50CNS0 disponible uniquement avec couvercle grillagé en acier inox AISI 304. Plusieurs options sur demande.

ES Amasadora de espiral con cabeza retráctil y bol extraíble.
Máquina para realizar diferentes tipos de masas, se aconseja especialmente para masas como pan, pizza y tortillas. Estructura recubierta con pintura antiarañazos - partes en contacto con los alimentos (bol, espiral y barra para romper la masa) de acero inoxidable - microinterruptor de seguridad en la tapa del bol. Tapa de policarbonato ahumado de serie excepto mod. 50CNS0 disponible sólo con tapa con rejilla de acero inoxidable AISI 304. Varias opciones bajo pedido.

EN Spiral kneader with liftable head and removable bowl.
Machine for the processing of different types of dough, especially suitable for soft doughs such as bread, pizza and piadina. Structure coated with scratchproof paint - parts in contact with food such as bowl, spiral and dough splitting rod are made of stainless steel - safety microswitch on bowl lid. Smoked polycarbonate lid as standard except for mod. 50CNS0 available only with AISI 304 stainless steel grilled lid. Various options on request.

DE Spiralteigknetmaschine mit anhebbaarem Kopf und abnehmbarer Schüssel. Maschine zur Zubereitung verschiedener Teigarten, besonders geeignet für weiche Teige wie Brot, Pizza und Piadina. Gehäuse mit kratzfester Lackierung beschichtet - Teile, die mit Lebensmitteln in Berührung kommen, wie Schüssel, Spirale und Teigknetstab, sind aus Edelstahl gefertigt. Sicherheitsmikroschalter am Behälterdeckel. Deckel aus geräuchertem Polycarbonat als Standard, außer bei Mod. 50CNS0 nur mit gegrilltem Deckel aus Edelstahl AISI 304 erhältlich. Verschiedene Optionen auf Anfrage.

RU Спиральный тестомес с подъемной траверсой и съемной чашей. Машина для приготовления различных видов теста, особенно подходит для мягкого теста, такого как хлеб, пицца и пиадина. Покрытие устойчивой к царапинам краской. Детали, контактирующие с пищевыми продуктами, такие как дежа, спирали и мешалка, изготовлены из нержавеющей стали. Стандартная крышка из дымчатого поликарбоната, за исключением модели 50CNS0, поставляемой только с решетчатой крышкой из нержавеющей стали AISI 304. Различные опции по запросу.



	12CNS0	18CNS0	25CNS0	38CNS0	50CNS0
	0,75 kW (1 HP) 0,75/0,55 kW (1/0,75 HP) - 2nd speed (optional)		1,5 kW (2 HP) 1,5/1,1 kW (2/1,5 HP) - 2nd speed (optional)		2,2 kW (3 HP) 3,5/2,5 kW (4,7/3,3 HP) 2nd speed (optional)
	230-400V/3N/50Hz				
	230V/1N/50Hz				-
	36 Kg/h	54 Kg/h	75 Kg/h	114 Kg/h	150 Kg/h
	12 Kg	18 Kg	25 Kg	38 Kg	50 Kg
	16 L (ø 320 x 210(h) mm)	22 L (ø 360 x 210(h) mm)	32 L (ø 400 x 260(h) mm)	42 L (ø 450 x 260(h) mm)	62 L (ø 500 x 310(h) mm)
	90 rpm 90 - 180 rpm - 2nd speed (optional)				80 rpm 80 - 160 rpm 2nd speed (optional)
	639 x 336 x 648÷932(h) mm	660 x 380 x 648÷951(h) mm	769 x 420 x 752÷1123(h) mm	800 x 474 x 764÷1160(h) mm	941 x 520 x 966÷1393(h) mm
					
	65 Kg	67 Kg	104 Kg	112 Kg	186 Kg
	74 Kg	76 Kg	115 Kg	123 Kg	207 Kg
	700 x 460 x 890(h) mm		850 x 550 x 1055(h) mm		1055 x 600 x 1276(h) mm
	0,290 m³		0,490 m³		0,803 m³

Optional 2nd speed - 2-я скорость опционально (3 PH)

Special Voltages - Разное питающее напряжение

Impastatrice a spirale con testa sollevabile e vasca fissa

SPIRAL KNEADER
PETRIN A SPIRAL
SPIRALTEIGKNETMASCHINE
AMASADORA DE ESPIRAL
СПИРАЛЬНЫЙ ТЕСТОМЕС

12FNO-18FNO
25FNO-38FNO
50FNO



Classic

IT Impastatrice a spirale con testa sollevabile e vasca fissa.
Macchina per realizzare diversi tipi di impasto, indicata soprattutto per impasti teneri come pane, pizza e piada. Struttura rivestita con vernice antigraffio - parti a contatto con gli alimenti quali vasca, spirale ed asta spacca pasta sono in acciaio inox - microinterruttore di sicurezza su coperchio vasca. Coperchio in policarbonato fumè di serie tranne per il mod. 50FN0 disponibile solo con coperchio grigliato in acciaio inox AISI 304. Vari optional a richiesta.

FR Pétrin à spirale avec tête relevable et cuve fixe.
Machine pour le pétrissage de différents types de pâte, particulièrement adaptée aux pâtes tendres telles que le pain, la pizza et la piadina. Structure recouverte de peinture anti-rayures - les parties en contact avec les aliments telles que la cuve, la spirale et la brise-pâte sont en acier inox - microinterrupteur de sécurité sur le couvercle de la cuve. Couvercle en polycarbonate fumé en standard sauf pour le mod. 50FN0 disponible uniquement avec couvercle grillagé en acier inox AISI 304. Plusieurs options sur demande.

ES Amasadora de espiral con cabeza retráctil y bol fija.
Máquina para realizar diferentes tipos de masas, se aconseja especialmente para masas como pan, pizza y tortillas. Estructura recubierta con pintura antiarañazos - partes en contacto con los alimentos (bol, espiral y barra para romper la masa) de acero inoxidable - microinterruptor de seguridad en la tapa del bol. Tapa de policarbonato ahumado de serie excepto mod. 50FN0 disponible sólo con tapa con rejilla de acero inoxidable AISI 304. Varias opciones bajo pedido.

EN Spiral kneader with liftable head and fixed bowl.
Machine for the processing of different types of dough, especially suitable for soft doughs such as bread, pizza and piadina. Structure coated with scratchproof paint - parts in contact with food such as bowl, spiral and dough splitting rod are made of stainless steel - safety microswitch on bowl lid. Smoked polycarbonate lid as standard except for mod. 50FN0 available only with AISI 304 stainless steel grilled lid. Various options on request.

DE Spiralteigknetmaschine mit anhebbarer Kopf und stationärer Schüssel.
Maschine zur Zubereitung verschiedener Teigarten, besonders geeignet für weiche Teige wie Brot, Pizza und Piadina. Gehäuse mit kratzfester Lackierung beschichtet - Teile, die mit Lebensmitteln in Berührung kommen, wie Schüssel, Spirale und Teigknetstab, sind aus Edelstahl gefertigt. Sicherheitsmikroschalter am Behälterdeckel. Deckel aus geräuchertem Polycarbonat als Standard, außer bei Mod. 50FN0 nur mit gegrilltem Deckel aus Edelstahl AISI 304 erhältlich. Verschiedene Optionen auf Anfrage.

RU Спиральный тестомес с подъемной траверсой и съемной чашей.
Машина для приготовления различных видов теста, особенно подходит для мягкого теста, такого как хлеб, пицца и пиадина. Покрытие устойчивой к царапинам краской. Детали, контактирующие с пищевыми продуктами, такие как дежа, спирали и мешалка, изготовлены из нержавеющей стали. Стандартная крышка из дымчатого поликарбоната, за исключением модели 50FN0, поставляемой только с решетчатой крышкой из нержавеющей стали AISI 304. Различные опции по запросу.



OPTIONAL
COPERCHIO GRIGLIATO
GRID LID

38FN0

	12FN0	18FN0	25FN0	38FN0	50FN0
	0,75 kW (1 HP) 0,75/0,55 kW (1/0,75 HP) - 2nd speed (optional)		1,5 kW (2 HP) 1,5/1,1 kW (2/1,5 HP) - 2nd speed (optional)		2,2 kW (3 HP) 3,5/2,5 kW (4,7/3,3 HP) 2nd speed (optional)
	230-400V/3N/50Hz				
	230V/1N/50Hz				-
	36 Kg/h	54 Kg/h	75 Kg/h	114 Kg/h	150 Kg/h
	12 Kg	18 Kg	25 Kg	38 Kg	50 Kg
	16 L (ø 320 x 210(h) mm)	22 L (ø 360 x 210(h) mm)	32 L (ø 400 x 260(h) mm)	42 L (ø 450 x 260(h) mm)	62 L (ø 500 x 310(h) mm)
	90 rpm 90 - 180 rpm - 2nd speed (optional)				80 rpm 80 - 160 rpm 2nd speed (optional)
	639 x 336 x 648÷932(h) mm	660 x 380 x 648÷951(h) mm	769 x 420 x 752÷1123(h) mm	800 x 474 x 764÷1160(h) mm	941 x 520 x 966÷1393(h) mm
					
	62 Kg	64 Kg	97 Kg	106 Kg	172 Kg
	71 Kg	73 Kg	108 Kg	117 Kg	193 Kg
	700 x 460 x 890(h) mm		850 x 550 x 1055(h) mm		1055 x 600 x 1276(h) mm
	0,290 m³		0,490 m³		0,803 m³

Optional 2nd speed - 2-я скорость опционально (3 PH)

Special Voltages - Разное питающее напряжение

OPTIONAL











7SB



Impastatrice a spirale con testa fissa

SPIRAL KNEADER
PETRIN A SPIRAL
SPIRALTEIGKNETMASCHINE
AMASADORA DE ESPIRAL
СПИРАЛЬНЫЙ ТЕСТОМЕС

- IT** Impastatrice a spirale con testa fissa. Macchina per realizzare diversi tipi di impasto, indicata soprattutto per impasti teneri come pane, pizza e piada. Struttura rivestita con vernice antigraffio - parti a contatto con gli alimenti quali vasca, spirale ed asta spacca pasta in acciaio inox - microinterruttore di sicurezza su coperchio vasca - disponibile solo con coperchio grigliato in acciaio inox AISI 304.
- EN** Spiral kneader with fixed head. Machine for the processing of different types of dough, especially suitable for soft doughs such as bread, pizza and piadina. Structure coated with scratch-proof paint - parts in contact with food such as bowl, spiral and dough splitting rod are made of stainless steel - safety microswitch on bowl lid. Only available with AISI 304 stainless steel grilled cover.
- FR** Pétrin à spirale avec tête fixe. Machine pour le pétrissage de différents types de pâte, particulièrement adaptée aux pâtes tendres telles que le pain, la pizza et la piadina. Structure recouverte de peinture anti-rayures - les parties en contact avec les aliments telles que la cuve, la spirale et la brise-pâte sont en acier inox - microrupteur de sécurité sur le couvercle de la cuve. Uniquement disponible avec couvercle grillé en acier inox AISI 304.
- DE** Spiraleteigknetmaschine mit festem Kopf. Maschine zur Zubereitung verschiedener Teigarten, besonders geeignet für weiche Teige wie Brot, Pizza und Piadina. Struktur mit kratzfester Lackierung beschichtet - Teile, die mit Lebensmitteln in Berührung kommen, wie Schüssel, Spirale und Teigknetstab, sind aus Edelstahl gefertigt. Sicherheitsmikroschalter am Behälterdeckel - nur mit Gitterabdeckung aus Edelstahl AISI 304 erhältlich.
- ES** Amasadora de espiral con cabeza fija. Máquina para realizar diferentes tipos de masas, se aconseja especialmente para masas como pan, pizza y tortillas. Estructura recubierta con pintura anti-arañazos - partes en contacto con los alimentos (bol, espiral y barra para romper la masa) de acero inoxidable - microinterruptor de seguridad en la tapa del bol. Solamente con tapa con red de acero inoxidable AISI 304.
- RU** Спиральный тестомес с неподвижной траверсой. Машина для приготовления различных видов теста, особенно подходит для мягкого теста, такого как хлеб, пицца и пиадина. Покрытие устойчивой к царапинам краской. Детали, контактирующие с пищевыми продуктами, такие как дежа, спирали и мешалка, изготовлены из нержавеющей стали. Предохранительный микровыключатель на крышке. Поставляется только с крышкой из нержавеющей стали AISI 304.

	7SB
	0,37 kW (0,5 HP)
	230-400V/3N/50Hz
	230V/1N/50Hz
	21 Kg/h
	7 Kg
	10 L (ø 260 x 200(h) mm)
	90 rpm
	545 x 280 x 620÷844(h) mm
	
	40 Kg
	49 Kg
	700 x 460 x 890(h) mm
	0,290 m³

Special Voltages - Разное питающее напряжение



12SNO-18SNO
25SNO-38SNO
50SNO



12SNO



50SNO

New

Impastatrice a spirale con testa fissa

SPIRAL KNEADER
PETRIN A SPIRAL
SPIRALTEIGKNETMASCHINE
AMASADORA DE ESPIRAL
СПИРАЛЬНЫЙ ТЕСТОМЕС

IT Impastatrice a spirale con testa fissa. Macchina per realizzare diversi tipi di impasto, indicata soprattutto per impasti teneri come pane, pizza e piada. Struttura rivestita con vernice antigraffio - parti a contatto con gli alimenti quali vasca, spirale ed asta spacca pasta sono in acciaio inox - microinterruttore di sicurezza su coperchio vasca. Coperchio in polycarbonato fumè di serie tranne per il mod. 50SN0 disponibile solo con coperchio grigliato in acciaio inox AISI 304.
Vari optional a richiesta.

FR Pétrin à spirale avec tête fixe. Machine pour le pétrissage de différents types de pâte, particulièrement adaptée aux pâtes tendres telles que le pain, la pizza et la piadina. Structure recouverte de peinture anti-rayures - les parties en contact avec les aliments telles que la cuve, la spirale et la brise-pâte sont en acier inox - microrupteur de sécurité sur le couvercle de la cuve. Couvercle en polycarbonate fumé en standard sauf pour le mod. 50SN0 disponible uniquement avec couvercle grillagé en acier inox AISI 304.
Plusieurs options sur demande.

ES Amasadora de espiral con cabeza fija. Máquina para realizar diferentes tipos de masas, se aconseja especialmente para masas como pan, pizza y tortillas. Estructura recubierta con pintura antiarañazos - partes en contacto con los alimentos (bol, espiral y barra para romper la masa) de acero inoxidable - microinterruptor de seguridad en la tapa del bol. Tapa de polycarbonato ahumado de serie excepto mod. 50SN0 disponible sólo con tapa con rejilla de acero inoxidable AISI 304.
Varias opciones bajo pedido.

EN Spiral kneader with fixed head. Machine for the processing of different types of dough, especially suitable for soft doughs such as bread, pizza and piadina. Structure coated with scratchproof paint - parts in contact with food such as bowl, spiral and dough splitting rod are made of stainless steel - safety microswitch on bowl lid. Smoked polycarbonate lid as standard except for mod. 50SN0 available only with AISI 304 stainless steel grilled lid.
Various options on request.

DE Spiralteigknetmaschine mit festem Kopf. Maschine zur Zubereitung verschiedener Teigarten, besonders geeignet für weiche Teige wie Brot, Pizza und Piadina. Gehäuse mit kratzfester Lackierung beschichtet - Teile, die mit Lebensmitteln in Berührung kommen, wie Schüssel, Spirale und Teigknetstab, sind aus Edelstahl gefertigt. Sicherheitsmikroschalter am Behälterdeckel. Deckel aus geräuchertem Polycarbonat als Standard, außer bei Mod. 50SN0 nur mit gegrilltem Deckel aus Edelstahl AISI 304 erhältlich.
Verschiedene Optionen auf Anfrage.

RU Спиральный тестомес с неподвижной траверсой. Машина для приготовления различных видов теста, особенно подходит для мягкого теста, такого как хлеб, пицца и пиадина. Покрытие устойчивой к царапинам краской. Детали, контактирующие с пищевыми продуктами, такие как дежа, спирали и мешалка, изготовлены из нержавеющей стали. Стандартная крышка из дымчатого поликарбоната, за исключением модели 50SN0, поставляемой только с решетчатой крышкой из нержавеющей стали AISI 304.
Различные опции по запросу.



	12SN0	18SN0	25SN0	38SN0	50SN0
	0,75 kW (1 HP) 0,75/0,55 kW (1/0,75 HP) - 2nd speed (optional)		1,5 kW (2 HP) 1,5/1,1 kW (2/1,5 HP) - 2nd speed (optional)		2,2 kW (3 HP) 3,5/2,5 kW (4,7/3,3 HP) 2nd speed (optional)
	230-400V/3N/50Hz				
	230V/1N/50Hz				-
	36 Kg/h	54 Kg/h	75 Kg/h	114 Kg/h	150 Kg/h
	12 Kg	18 Kg	25 Kg	38 Kg	50 Kg
	16 L (ø 320 x 210(h) mm)	22 L (ø 360 x 210(h) mm)	32 L (ø 400 x 260(h) mm)	42 L (ø 450 x 260(h) mm)	62 L (ø 500 x 310(h) mm)
	90 rpm 90 - 180 rpm - 2nd speed (optional)				80 rpm 80 - 160 rpm 2nd speed (optional)
	639 x 336 x 648÷932(h) mm	660 x 380 x 648÷951(h) mm	769 x 420 x 752÷1123(h) mm	800 x 474 x 764÷1160(h) mm	941 x 520 x 966÷1393(h) mm
					
	58 Kg	60 Kg	92 Kg	100 Kg	160 Kg
	67 Kg	69 Kg	103 Kg	111 Kg	181 Kg
	700 x 460 x 890(h) mm		850 x 550 x 1055(h) mm		1055 x 600 x 1276(h) mm
	0,290 m³		0,490 m³		0,803 m³

Optional 2nd speed - 2-я скорость опционально (3 PH)

Special Voltages - Разное питающее напряжение

7SB

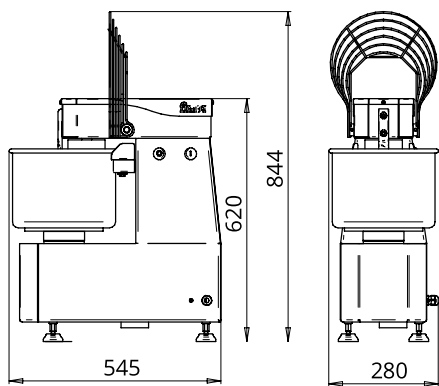

12 SN0/FN0/CNS0

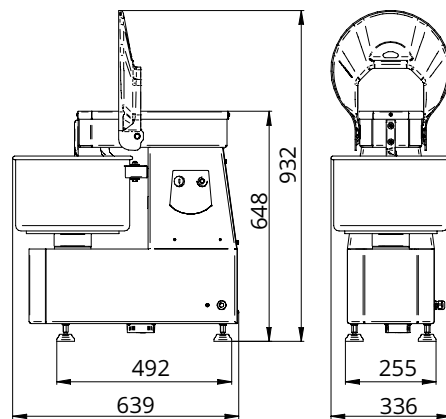

18 SN0/FN0/CNS0

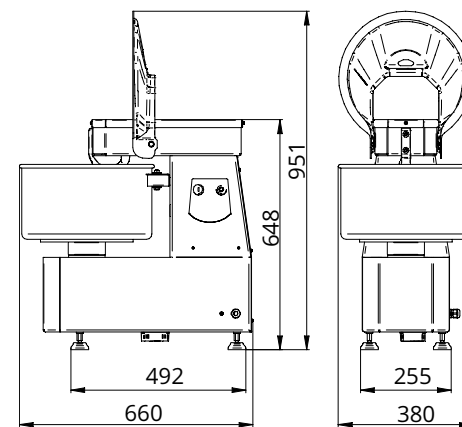

25 SN0/FN0/CNS0

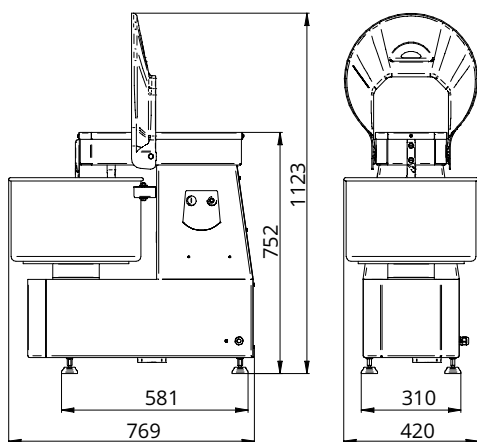

38 SN0/FN0/CNS0

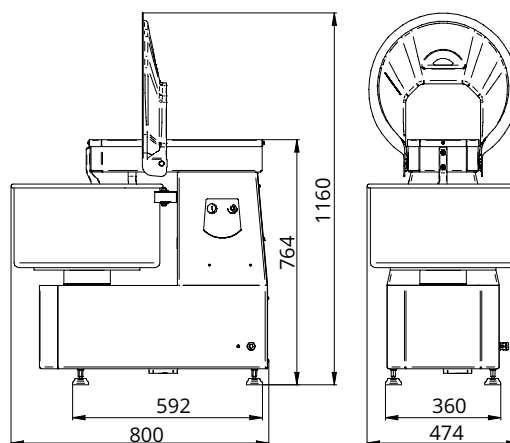

50 SN0/FN0/CNS0

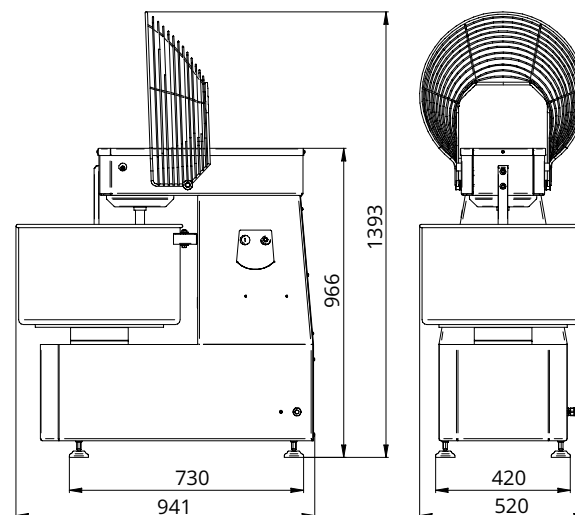

15LN-20LN
30LN-40LN



20LN



40LN

Impastatrice a spirale light

SPIRAL KNEADER
PETRIN A SPIRAL
SPIRALTEIGKNETMASCHINE
AMASADORA DE ESPIRAL
СПИРАЛЬНЫЙ ТЕСТОМЕС

IT Impastatrice a spirale light. Macchina per realizzare diversi tipi di impasto, indicata soprattutto per impasti teneri come pane, pizza e piada. Struttura rivestita con vernice antigraffio - parti a contatto con gli alimenti (vasca, spirale) in acciaio inox AISI 304 - microinterruttore di sicurezza su coperchio vasca - con asta spacca pasta - coperchio in polycarbonato fumè. Vari optional a richiesta, tra cui coperchio grigliato in acciaio inox AISI 304.

FR Pétrin à spirale "light". Machine pour le pétrissage de différents types de pâte, particulièrement adaptée aux pâtes tendres telles que le pain, la pizza et la piadina. Structure recouverte de peinture anti-rayures - les parties en contact avec les aliments, telles que la cuve et la spirale, sont en acier inox AISI 304 - microinterruteur de sécurité sur le couvercle de la cuve - avec Barre coupe-pâte - couvercle en polycarbonate fumé de série. Différentes options sur demande, incluant couvercle grillé en acier inox AISI 304.

ES Amasadora de espiral light. Máquina para realizar diferentes tipos de masas, se aconseja especialmente para masas como pan, pizza y tortillas. Estructura recubierta con pintura anti-arañazos - partes en contacto con los alimentos (bol y espiral) de acero inoxidable AISI 304 - microinterruptor de seguridad en tapa del bol - con cortador de masa - tapa de polycarbonato fumé. Se pueden pedir unos extras o accesorios como tapa con red de acero inoxidable AISI 304.

EN Spiral kneader light. Machine for the processing of different types of dough, especially suitable for soft doughs such as bread, pizza and piadina. Structure coated with scratch-proof paint - parts in contact with food, such as bowl and spiral, are made of stainless steel AISI 304 - safety microswitch on bowl lid - with dough cutter - smoked polycarbonate lid as standard. Different options on request, including AISI 304 stainless steel grilled cover.

DE Spiralteigknetmaschine "Light". Maschine zur Zubereitung von verschiedenen Teigtypen, besonders geeignet für weichen Brot, Piada und Pizzateig. Struktur mit kratzfestem Lack beschichtet - Teile in Kontakt mit Lebensmitteln (Behälter und Spirale) aus Edelstahl AISI 304 - Sicherheitsmikroschalter am Behälterdeckel. mit Teigschneidestab. Deckel in rauchfarbenem Polycarbonat serienmäßig. Auf Anfrage sind verschiedene Zubehörteile erhältlich, einschließlich der Gitterabdeckung aus Edelstahl AISI 304.

RU Спиральный тестомес "Light". Машина для приготовления различных видов теста, особенно подходит для мягкого теста, такого как хлеб, пицца и пиадина. Покрытие устойчивой к царапинам краской. Детали, контактирующие с пищевыми продуктами, такие как дежа и спирали, изготовлены из нержавеющей стали AISI 304. Предохранительный микровыключатель на крышке. с ножом для теста - в стандартной комплектации крышка из поликарбоната дымчато-серого цвета. Дополнительное оборудование, например, решетчатая крышка из нержавеющей стали AISI 304, по запросу.



	15LN	20LN	30LN	40LN
	0,37 kW (0,5 HP) 0,55/0,37 kW (0,7/0,5 HP) only 3 PH 2nd speed (optional)		0,75 kW (1 HP) 0,75/0,55 kW (1/0,75 HP) 2nd speed (optional)	1,1 kW (1,5 HP) 0,75/1,1 kW (1/1,5 HP) 2nd speed (optional)
	230-400V/3N/50Hz			
	230V/1N/50Hz			
	30 Kg/h	48 Kg/h	75 Kg/h	108 Kg/h
	10 Kg	16 Kg	25 Kg	36 Kg
	15 L ø 320 x 210(h) mm	20 L ø 360 x 210(h) mm	30 L (ø 400 x 260(h) mm)	40 L (ø 450 x 260(h) mm)
	90 rpm 90 - 180 rpm 2nd speed (optional)			
	639 x 336 x 648÷932(h) mm	660 x 380 x 648÷951(h) mm	769 x 420 x 752÷1123(h) mm	800 x 474 x 764÷1160(h) mm
				
	52 Kg	54 Kg	81 Kg	88 Kg
	61 Kg	63 Kg	92 Kg	99 Kg
	700 x 460 x 890(h) mm		850 x 550 x 1060(h) mm	
	0,290 m³		0,490 m³	

Optional 2nd speed - 2-я скорость опционально (3 PH)

Special Voltages - Разное питающее напряжение

15LN

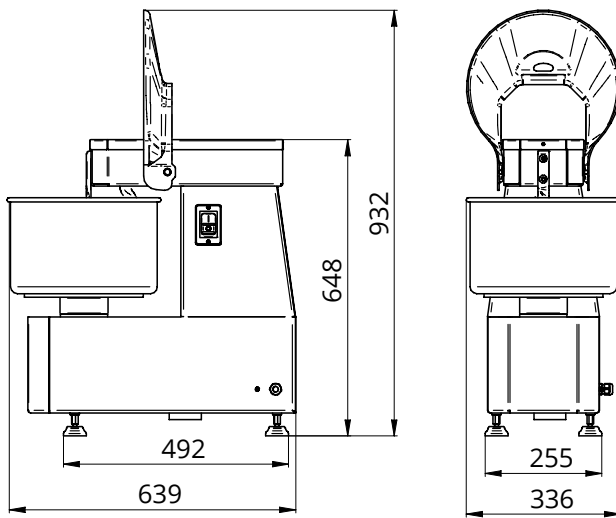

20LN

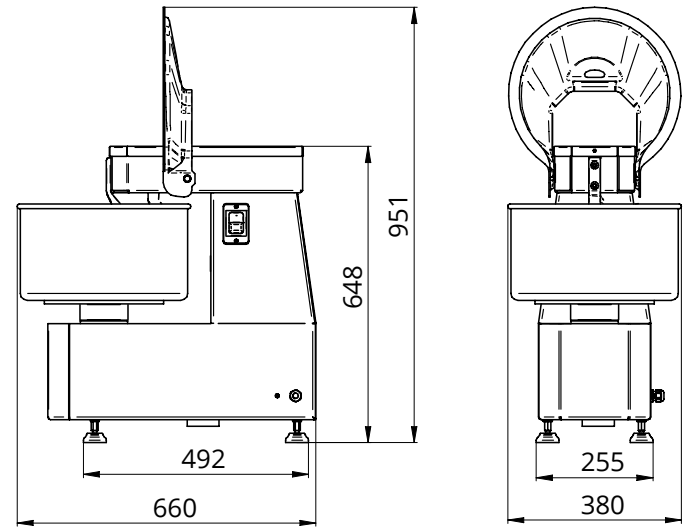

30LN

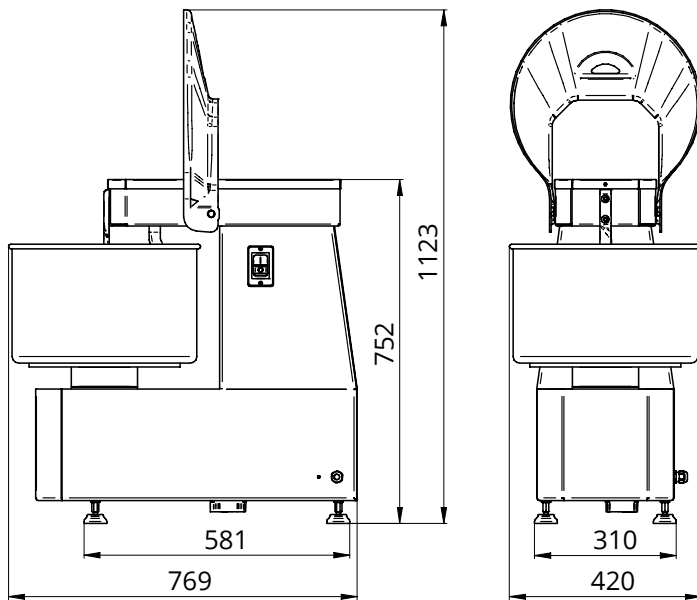

40LN

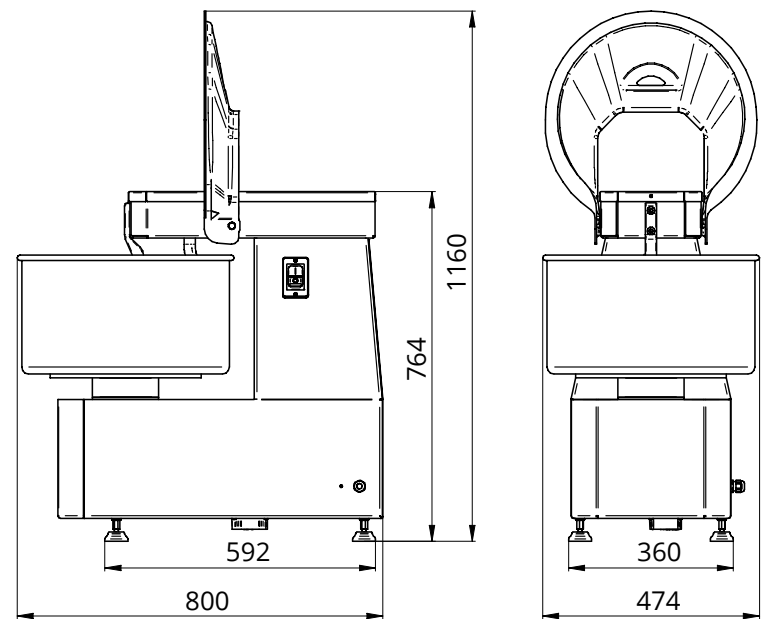

12SR-18SR
25SR-38SR-50SR



12SR



50SR

Impastatrice a spirale
con testa sollevabile e vasca estraibile

SPIRAL KNEADER
PETRIN A SPIRAL
SPIRALTEIGKNETMASCHINE
AMASADORA DE ESPIRAL
СПИРАЛЬНЫЙ ТЕСТОМЕС

IT Impastatrice a spirale con testa sollevabile e vasca estraibile.
Macchina per realizzare diversi tipi di impasto, indicata soprattutto per impasti teneri come pane, pizza e piada. Struttura rivestita con vernice antigraffio - parti a contatto con gli alimenti quali vasca, spirale ed asta spacca pasta sono in acciaio inox - microinterruttore di sicurezza su coperchio vasca. Coperchio in policarbonato fumè di serie tranne per il mod. 50SR disponibile solo con coperchio grigliato in acciaio inox AISI 304. Vari optional a richiesta.

FR Pétrin à spirale avec tête relevable et cuve amovible.
Machine pour le pétrissage de différents types de pâte, particulièrement adaptée aux pâtes tendres telles que le pain, la pizza et la piadina. Structure recouverte de peinture anti-rayures - les parties en contact avec les aliments telles que la cuve, la spirale et la brise-pâte sont en acier inox - microinterrupteur de sécurité sur le couvercle de la cuve. Couvercle en polycarbonate fumé en standard sauf pour le mod. 50SR disponible uniquement avec couvercle grillagé en acier inox AISI 304. Plusieurs options sur demande.

ES Amasadora de espiral con cabeza retráctil y bol extraíble.
Máquina para realizar diferentes tipos de masas, se aconseja especialmente para masas como pan, pizza y tortillas. Estructura recubierta con pintura antiarañazos - partes en contacto con los alimentos (bol, espiral y barra para romper la masa) de acero inoxidable - microinterruptor de seguridad en la tapa del bol. Tapa de policarbonato ahumado de serie excepto mod. 50SR disponible sólo con tapa con rejilla de acero inoxidable AISI 304. Varias opciones bajo pedido.

EN Spiral kneader with liftable head and removable bowl.
Machine for the processing of different types of dough, especially suitable for soft doughs such as bread, pizza and piadina. Structure coated with scratchproof paint - parts in contact with food such as bowl, spiral and dough splitting rod are made of stainless steel - safety microswitch on bowl lid. Smoked polycarbonate lid as standard except for mod. 50SR available only with AISI 304 stainless steel grilled lid. Various options on request.

DE Spiralteigknetmaschine mit anhebbaarem Kopf und abnehmbarer Schüssel. Maschine zur Zubereitung verschiedener Teigarten, besonders geeignet für weiche Teige wie Brot, Pizza und Piadina. Gehäuse mit kratzfester Lackierung beschichtet - Teile, die mit Lebensmitteln in Berührung kommen, wie Schüssel, Spirale und Teigknetstab, sind aus Edelstahl gefertigt. Sicherheitsmikroschalter am Behälterdeckel. Deckel aus geräuchertem Polycarbonat als Standard, außer bei Mod. 50SR nur mit gegrilltem Deckel aus Edelstahl AISI 304 erhältlich. Verschiedene Optionen auf Anfrage.

RU Спиральный тестомес с подъемной траверсой и съёмной чашей. Машина для приготовления различных видов теста, особенно подходит для мягкого теста, такого как хлеб, пицца и пиадина. Покрытие устойчивой к царапинам краской. Детали, контактирующие с пищевыми продуктами, такие как дежа, спирали и мешалка, изготовлены из нержавеющей стали. Стандартная крышка из дымчатого поликарбоната, за исключением модели 50SR, поставляемой только с решетчатой крышкой из нержавеющей стали AISI 304. Различные опции по запросу.



GUARDA IL VIDEO
WATCH THE VIDEO



18SR

	12SR	18SR	25SR	38SR	50SR
	0,75 kW (1 HP) 0,75/0,55 kW (1/0,75 HP) - 2nd speed (optional)		1,5 kW (2 HP) 1,5/1,1 kW (2/1,5 HP) - 2nd speed (optional)		2,2 kW (3 HP) 3,5/2,5 kW (4,7/3,3 HP) 2nd speed (optional)
	230-400V/3N/50Hz				
	230V/1N/50Hz				-
	36 Kg/h	54 Kg/h	75 Kg/h	114 Kg/h	150 Kg/h
	12 Kg	18 Kg	25 Kg	38 Kg	50 Kg
	16 L (ø 320 x 210(h) mm)	22 L (ø 360 x 210(h) mm)	32 L (ø 400 x 260(h) mm)	42 L (ø 450 x 260(h) mm)	62 L (ø 500 x 310(h) mm)
	90 rpm 90 - 180 rpm - 2nd speed (optional)				80 rpm 80 - 160 rpm 2nd speed (optional)
	639 x 336 x 750±932(h) mm	660 x 380 x 750±951(h) mm	769 x 420 x 864±1123(h) mm	800 x 474 x 879±1160(h) mm	941 x 520 x 1074±1393(h) mm
					
	65 Kg	67 Kg	104 Kg	112 Kg	186 Kg
	74 Kg	76 Kg	115 Kg	123 Kg	207 Kg
	700 x 460 x 890(h) mm		850 x 550 x 1055(h) mm		1055 x 600 x 1276(h) mm
	0,290 m³		0,490 m³		0,803 m³

Optional 2nd speed - 2-я скорость опционально (3 PH)

Special Voltages - Разное питающее напряжение

Impastatrice a spirale

con testa sollevabile e vasca fissa

SPIRAL KNEADER
PETRIN A SPIRAL
SPIRALTEIGKNETMASCHINE
AMASADORA DE ESPIRAL
СПИРАЛЬНЫЙ ТЕСТОМЕС

12SL-18SL
25SL-38SL-50SL



IT Impastatrice a spirale con testa sollevabile e vasca fissa.
Macchina per realizzare diversi tipi di impasto, indicata soprattutto per impasti teneri come pane, pizza e piada. Struttura rivestita con vernice antigraffio - parti a contatto con gli alimenti quali vasca, spirale ed asta spacca pasta sono in acciaio inox - microinterruttore di sicurezza su coperchio vasca. Coperchio in policarbonato fumè di serie tranne per il mod. 50SL disponibile solo con coperchio grigliato in acciaio inox AISI 304. Vari optional a richiesta.

FR Pétrin à spirale avec tête relevable et cuve fixe.
Machine pour le pétrissage de différents types de pâte, particulièrement adaptée aux pâtes tendres telles que le pain, la pizza et la piadina. Structure recouverte de peinture anti-rayures - les parties en contact avec les aliments telles que la cuve, la spirale et la brise-pâte sont en acier inox - microrupteur de sécurité sur le couvercle de la cuve. Couvercle en polycarbonate fumé en standard sauf pour le mod. 50SL disponible uniquement avec couvercle grillagé en acier inox AISI 304. Plusieurs options sur demande.

ES Amasadora de espiral con cabeza retráctil y bol fija.
Máquina para realizar diferentes tipos de masas, se aconseja especialmente para masas como pan, pizza y tortillas. Estructura recubierta con pintura antiarañazos - partes en contacto con los alimentos (bol, espiral y barra para romper la masa) de acero inoxidable - microinterruptor de seguridad en la tapa del bol. Tapa de policarbonato ahumado de serie excepto mod. 50SL disponible sólo con tapa con rejilla de acero inoxidable AISI 304. Varias opciones bajo pedido.

EN Spiral kneader with liftable head and fixed bowl.
Machine for the processing of different types of dough, especially suitable for soft doughs such as bread, pizza and piadina. Structure coated with scratchproof paint - parts in contact with food such as bowl, spiral and dough splitting rod are made of stainless steel - safety microswitch on bowl lid. Smoked polycarbonate lid as standard except for mod. 50SL available only with AISI 304 stainless steel grilled lid. Various options on request.

DE Spiralteigknetmaschine mit anhebbarem Kopf und stationärer Schüssel.
Maschine zur Zubereitung verschiedener Teigarten, besonders geeignet für weiche Teige wie Brot, Pizza und Piadina. Gehäuse mit kratzfester Lackierung beschichtet - Teile, die mit Lebensmitteln in Berührung kommen, wie Schüssel, Spirale und Teigknetstab, sind aus Edelstahl gefertigt. Sicherheitsmikroschalter am Behälterdeckel. Deckel aus geräuchertem Polycarbonat als Standard, außer bei Mod. 50SL nur mit gegrilltem Deckel aus Edelstahl AISI 304 erhältlich. Verschiedene Optionen auf Anfrage.

RU Спиральный тестомес с подъемной траверсой и съемной чашей.
Машина для приготовления различных видов теста, особенно подходит для мягкого теста, такого как хлеб, пицца и пиадина. Покрытие устойчивой к царапинам краской. Детали, контактирующие с пищевыми продуктами, такие как дежа, спирали и мешалка, изготовлены из нержавеющей стали. Стандартная крышка из дымчатого поликарбоната, за исключением модели 50SL, поставляемой только с решетчатой крышкой из нержавеющей стали AISI 304. Различные опции по запросу.



GUARDA IL VIDEO
WATCH THE VIDEO



12SL

	12SL	18SL	25SL	38SL	50SL
	0,75 kW (1 HP) 0,75/0,55 kW (1/0,75 HP) - 2nd speed (optional)		1,5 kW (2 HP) 1,5/1,1 kW (2/1,5 HP) - 2nd speed (optional)		2,2 kW (3 HP) 3,5/2,5 kW (4,7/3,3 HP) 2nd speed (optional)
	230-400V/3N/50Hz				
	230V/1N/50Hz				-
	36 Kg/h	54 Kg/h	75 Kg/h	114 Kg/h	150 Kg/h
	12 Kg	18 Kg	25 Kg	38 Kg	50 Kg
	16 L (ø 320 x 210(h) mm)	22 L (ø 360 x 210(h) mm)	32 L (ø 400 x 260(h) mm)	42 L (ø 450 x 260(h) mm)	62 L (ø 500 x 310(h) mm)
	90 rpm 90 - 180 rpm - 2nd speed (optional)				80 rpm 80 - 160 rpm 2nd speed (optional)
	639 x 336 x 750±932(h) mm	660 x 380 x 750±951(h) mm	769 x 420 x 864±1123(h) mm	800 x 474 x 879±1160(h) mm	941 x 520 x 1074±1393(h) mm
					
	62 Kg	64 Kg	97 Kg	106 Kg	172 Kg
	71 Kg	73 Kg	108 Kg	117 Kg	193 Kg
	700 x 460 x 890(h) mm		850 x 550 x 1055(h) mm		1055 x 600 x 1276(h) mm
	0,290 m³		0,490 m³		0,803 m³

Optional 2nd speed - 2-я скорость опционально (3 PH)

Special Voltages - Разное питающее напряжение

OPTIONAL



Eco

121

12SB-18SB
25SB-38SB-50SB



12SB



50SB

Impastatrice a spirale con testa fissa

SPIRAL KNEADER
PETRIN A SPIRAL
SPIRALTEIGKNETMASCHINE
AMASADORA DE ESPIRAL
СПИРАЛЬНЫЙ ТЕСТОМЕС

IT Impastatrice a spirale con testa fissa.
Macchina per realizzare diversi tipi di impasto, indicata soprattutto per impasti teneri come pane, pizza e piada. Struttura rivestita con vernice antigraffio - parti a contatto con gli alimenti quali vasca, spirale ed asta spacca pasta sono in acciaio inox - microinterruttore di sicurezza su coperchio vasca. Coperchio in policarbonato fumè di serie tranne per il mod. 50SB disponibile solo con coperchio grigliato in acciaio inox AISI 304. Vari optional a richiesta.

FR Pétrin à spirale avec tête fixe.
Machine pour le pétrissage de différents types de pâte, particulièrement adaptée aux pâtes tendres telles que le pain, la pizza et la piadina. Structure recouverte de peinture anti-rayures - les parties en contact avec les aliments telles que la cuve, la spirale et la brise-pâte sont en acier inox - microinterrupteur de sécurité sur le couvercle de la cuve. Couvercle en polycarbonate fumé en standard sauf pour le mod. 50SB disponible uniquement avec couvercle grillagé en acier inox AISI 304. Plusieurs options sur demande.

ES Amasadora de espiral con cabeza fija.
Máquina para realizar diferentes tipos de masas, se aconseja especialmente para masas como pan, pizza y tortillas. Estructura recubierta con pintura antiarañazos - partes en contacto con los alimentos (bol, espiral y barra para romper la masa) de acero inoxidable - microinterruptor de seguridad en la tapa del bol. Tapa de policarbonato ahumado de serie excepto mod. 50SB disponible sólo con tapa con rejilla de acero inoxidable AISI 304. Varias opciones bajo pedido.

EN Spiral kneader with fixed head.
Machine for the processing of different types of dough, especially suitable for soft doughs such as bread, pizza and piadina. Structure coated with scratchproof paint - parts in contact with food such as bowl, spiral and dough splitting rod are made of stainless steel - safety microswitch on bowl lid. Smoked polycarbonate lid as standard except for mod. 50SB available only with AISI 304 stainless steel grilled lid. Various options on request.

DE Spiralteigknetmaschine mit festem Kopf.
Maschine zur Zubereitung verschiedener Teigarten, besonders geeignet für weiche Teige wie Brot, Pizza und Piadina. Gehäuse mit kratzfester Lackierung beschichtet - Teile, die mit Lebensmitteln in Berührung kommen, wie Schüssel, Spirale und Teigknetstab, sind aus Edelstahl gefertigt. Sicherheitsmikroschalter am Behälterdeckel. Deckel aus geräuchertem Polycarbonat als Standard, außer bei Mod. 50SB nur mit gegrilltem Deckel aus Edelstahl AISI 304 erhältlich. Verschiedene Optionen auf Anfrage.

RU Спиральный тестомес с неподвижной траверсой.
Машина для приготовления различных видов теста, особенно подходит для мягкого теста, такого как хлеб, пицца и пиадина. Покрытие устойчивой к царапинам краской. Детали, контактирующие с пищевыми продуктами, такие как дежа, спирали и мешалка, изготовлены из нержавеющей стали. Стандартная крышка из дымчатого поликарбоната, за исключением модели 50SB, поставляемой только с решетчатой крышкой из нержавеющей стали AISI 304. Различные опции по запросу.



GUARDA IL VIDEO
WATCH THE VIDEO

	12SB	18SB	25SB	38SB	50SB
	0,75 kW (1 HP) 0,75/0,55 kW (1/0,75 HP) - 2nd speed (optional)		1,5 kW (2 HP) 1,5/1,1 kW (2/1,5 HP) - 2nd speed (optional)		2,2 kW (3 HP) 3,5/2,5 kW (4,7/3,3 HP) 2nd speed (optional)
	230-400V/3N/50Hz				
	230V/1N/50Hz				-
	36 Kg/h	54 Kg/h	75 Kg/h	114 Kg/h	150 Kg/h
	12 Kg	18 Kg	25 Kg	38 Kg	50 Kg
	16 L (ø 320 x 210(h) mm)	22 L (ø 360 x 210(h) mm)	32 L (ø 400 x 260(h) mm)	42 L (ø 450 x 260(h) mm)	62 L (ø 500 x 310(h) mm)
	90 rpm 90 - 180 rpm - 2nd speed (optional)				80 rpm 80 - 160 rpm 2nd speed (optional)
	639 x 336 x 750±932(h) mm	660 x 380 x 750±951(h) mm	769 x 420 x 864±1123(h) mm	800 x 474 x 879±1160(h) mm	941 x 520 x 1074±1393(h) mm
					
	58 Kg	60 Kg	92 Kg	100 Kg	160 Kg
	67 Kg	69 Kg	103 Kg	111 Kg	181 Kg
	700 x 460 x 890(h) mm		850 x 550 x 1055(h) mm		1055 x 600 x 1276(h) mm
	0,290 m³		0,490 m³		0,803 m³

Optional 2nd speed - 2-я скорость опционально (3 PH)

Special Voltages - Разное питающее напряжение

12 SB/SL/SR + HYDRA

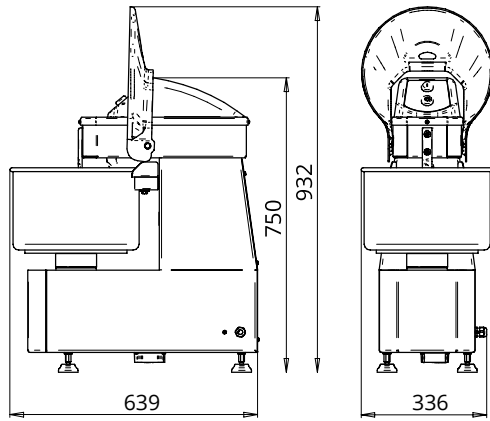

18 SB/SL/SR + HYDRA

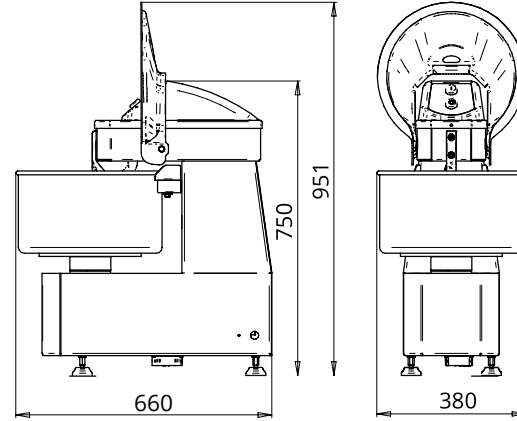

25 SB/SL/SR + HYDRA

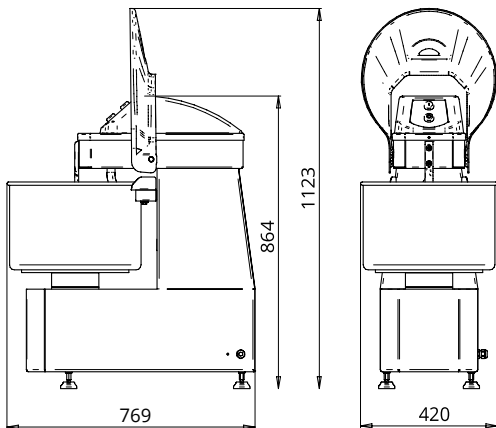

38 SB/SL/SR + HYDRA

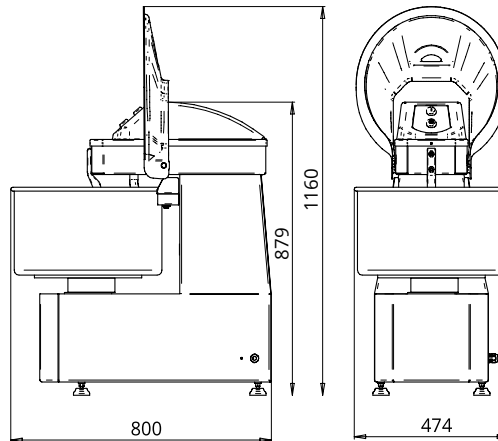

50 SB/SL/SR + HYDRA

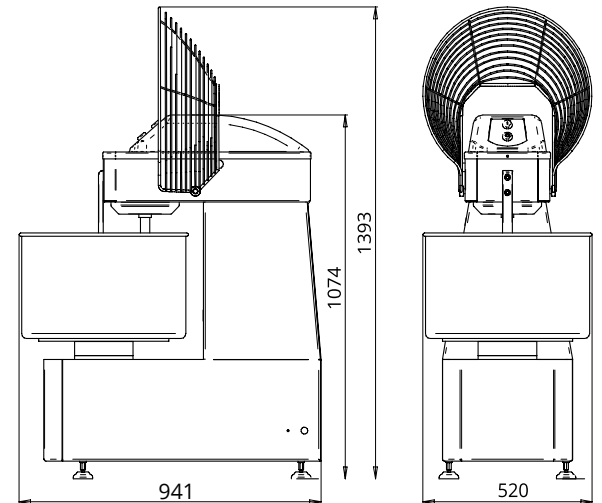

Optional

ACCESSORIES
ACCESSOIRES
ZUBEHÖR
ACCESORIOS
AKCECCYAPЫ

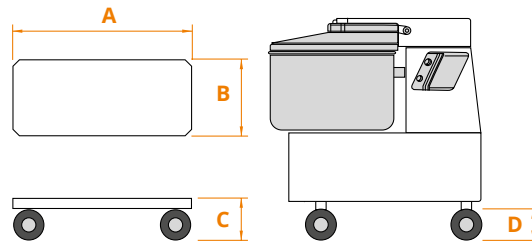

	7 SB	12 SB-SR-SL CNS0-FN0-SN0	15 LN	18 SB-SR-SL CNS0-FN0-SN0	20 LN	25 SB-SR-SL CNS0-FN0-SN0	30 LN	38 SB-SR-SL CNS0-FN0-SN0	40 LN	50 SB-SR-SL CNS0-FN0-SN0
A	420 mm	520 mm			600 mm					760 mm
B	250 mm	280 mm			330 mm			380 mm		470 mm
C					80 mm					130 mm
D					130 mm					170 mm

	Carrello - Trolley - Chariot Wagen - Carrito - Тележка
CAVIMP7R	7 SB
CAVIMP1218R	12-18 SB-SR-SL-CNS0-FN0-SN0 15-20LN
CAVIMP25R	25 SB-SR-SL-CNS0-FN0-SN0 30-40LN
CAVIMP38R	38 SB-SR-SL-CNS0-FN0-SN0
CAVIMP50R	50 SB-SR-SL-CNS0-FN0-SN0



CARRELLO - TROLLEY

	Kit ruote - Set of wheels - Kit de roues Rädersatz - Juego de ruedas - Набор колёс
KITRUOTEIMSN	7-12-18-25-38 SB-SR-SL-CNS0-FN0-SN0 15-20-30-40LN
KITRUOTEIM50N	50 SB-SR-SL-CNS0-FN0-SN0



TIMER MECCANICO
MECCANIC TIMER

Timer meccanico - Mechanical timer
Minuterie mécanique - Mechanischer Timer
Temporizador mecánico - Механический таймер

7-12-18-25-38-50 SB-SR-SL-CNS0-FN0-SN0
15-20-30-40 LN

Salvatore - Motor overload protection
Discontacteur - Motorschutz
Interruptor de sobrecarga - Защита двигателя

7-12-18-25-38-50 SB-SR-SL-CNS0-FN0-SN0
15-20-30-40 LN



COPERCHIO GRIGLIATO
STAINLESS STEEL GRIDDED LID

Coperchio grigliato inox - Stainless steel gridded lid
Couverture grillé en acier inox - Gitterdeckel aus Edelstahl
Tapa con red de acero inoxidable
Поставляется с крышкой из нержавеющей стали

12-18-25-38 SB-SR-SL-CNS0-FN0-SN0
15-20-30-40 LN



TIMER DIGITALE
DIGITAL TIMER

Timer digitale, solo con norme CE, no con salvatore
Digital timer, only CE, not with motor overload protection
Minuteur numérique, seulement CE, pas avec discontacteur
Digitalzeitregler, nur nach CE-Normen, nicht mit Motorschutz
Temporizador digital, sólo CE,
no con interruptor de sobrecarga
Цифровой таймер, только по стандартам CE,
не с защитой двигателя

12-18-25-38-50 SB-SR-SL-CNS0-FN0-SN0



MANIGLIE ESTRAZIONE PENTOLA
POT EXTRACTION HANDLES

Maniglie estrazione pentola - Pot extraction handles
Poignées d'extraction de la cuve - Schüsselauszehgriffe
Manijas para extraer el bol - Ручки для извлечения дежи

ACMANIM 12-18-25 SR-CNS0

ACMANIM3850 38-50 SR-CNS0

OPTIONAL

IMPASTATRICI A SPIRALE IDEALI PER L'ALTA IDRATAZIONE

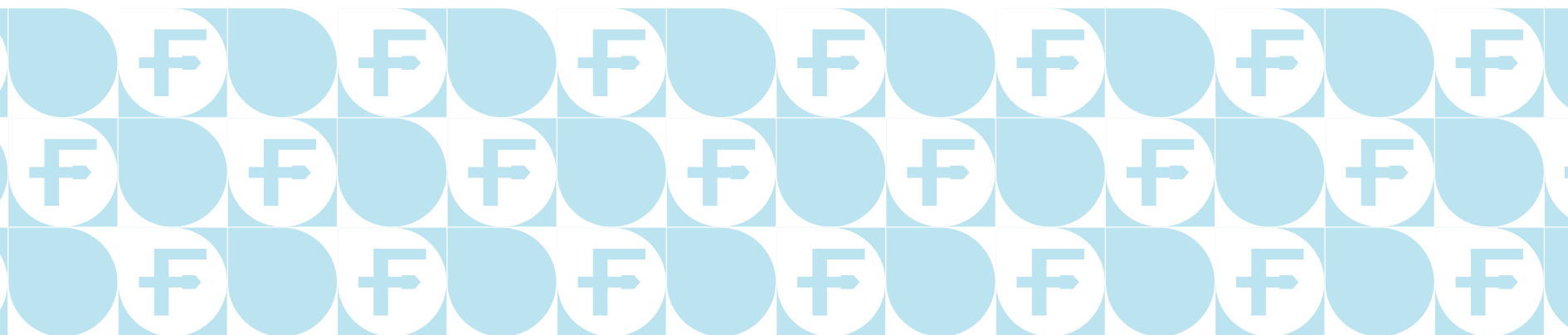

Impastatrice a spirale ideale per l'alta idratazione.
Disponibile in varie misure con testa sollevabile e vasca estraibile
(SR); testa sollevabile e vasca fissa (SL); testa fissa (SB).
Con pannello comandi meccanico o digitale.
Scegli la tua "Hydraplus"!

Spiral kneader ideal for high hydration.
Available in different sizes with liftable head and removable bowl
(SR); liftable head and fixed bowl (SL); fixed head (SB).
With mechanical or digital control panel.
Choose your "Hydraplus"!

SPIRAL KNEADER IDEAL FOR HIGH HYDRATION



Variatore di velocità fino a **250 rpm**
Speed variator up to **250 rpm**



Motore Brushless con inverter
Brushless motor with inverter



Alta idratazione fino al 90%
High hydration up to 90%



Capacità della vasca da 12 a 50 kg
Bowl capacity from 12 to 50 kg



Ottima per lavorazioni come pinsa, pizza
in teglia e alla pala
Excellent for processes such as pinsa, pan
and shovel pizza

HYD12SRM
HYD18SRM-HYD25SRM
HYD38SRM-HYD50SRM



HYD12SRM



HYD18SRM

**PANNELLO COMANDI MECCANICO
MECHANICAL CONTROL PANEL**

Impastatrice a spirale
con testa sollevabile e vasca estraibile

SPIRAL KNEADER
PETRIN A SPIRAL
SPIRALTEIGKNETMASCHINE
AMASADORA DE ESPIRAL
СПИРАЛЬНЫЙ ТЕСТОМЕС

IT Impastatrice a spirale "Hydraplus" con pannello comandi meccanico, testa sollevabile e vasca estraibile. Macchina per realizzare diversi tipi di impasto, indicata soprattutto per impasti ad alta idratazione fino al 90%. Struttura rivestita con vernice antigraffio - parti a contatto con gli alimenti quali vasca, spirale ed asta spacca pasta sono in acciaio inox - microinterruttore di sicurezza su coperchio vasca. Coperchio in polycarbonato fumè di serie tranne per il mod. HYD50 disponibile solo con coperchio grigliato in acciaio inox AISI 304.
Optional: timer meccanico - coperchio grigliato in acciaio inox AISI 304.

FR Mélangeur à spirale "Hydraplus" avec panneau de commande mécanique, tête relevable et cuve amovible.
Machine pour la fabrication de différents types de pâtes, particulièrement adaptée aux pâtes à haute hydratation finalement jusqu'à 90%. Structure recouverte de peinture anti-rayures - parties en contact avec les aliments telles que cuve, spirale et tige de séparation de la pâte en acier inox - micro-interrupteur de sécurité sur le couvercle de la cuve.
Couvercle en polycarbonate fumé en standard sauf pour le mod. HYD50 disponible uniquement avec couvercle grillagé en acier inox AISI 304.
En option: minuterie mécanique - couvercle à grille en acier inox AISI 304.

ES Amasadora espiral "Hydraplus" con panel de control mecánico, cabezal elevable y cuba extraíble.
Máquina para la elaboración de diferentes tipos de masas, especialmente indicada para masas de alta hidratación finalmente hasta el 90%. Estructura revestida con pintura antiarañazos - partes en contacto con los alimentos como cuba, espiral y varilla divisora de masa son de acero inoxidable - microinterruptor de seguridad en la tapa de la cuba. Tapa de polycarbonato ahumado de serie excepto mod. HYD50 disponible sólo con tapa con rejilla de acero inoxidable AISI 304. Opcional: temporizador mecánico - tapa con rejilla de acero inoxidable AISI 304.

EN "Hydraplus" spiral kneader with mechanical control panel, liftable head and removable bowl.
Machine for making different types of dough, especially suitable for high-hydration doughs up to 90%. Structure coated with scratch-proof paint - parts in contact with foodstuffs such as bowl, spiral and dough splitter rod are in stainless steel - safety microswitch on bowl lid. Smoked polycarbonate lid as standard except for mod. HYD50 available only with AISI 304 stainless steel gridded lid.
Optional: mechanical timer AISI 304 stainless steel gridded lid.

DE "Hydraplus"-Spiralkneiter mit mechanischem Bedienfeld, anhebbaarem Kopf und abnehmbarer Schüssel.
Maschine zur Herstellung verschiedener Teigsorten, besonders geeignet für Teige mit hohem Feuchtigkeitsgehalt bis zu 90%. Struktur mit kratzfester Farbe beschichtet - Teile, die mit Lebensmitteln in Berührung kommen, wie Schüssel, Spirale und Teigspaltstab, sind aus Edelstahl - Sicherheitsmikroschalter auf dem Schüsseldeckel. Deckel aus geräuchertem Polycarbonat als Standard, außer bei Mod. HYD50 nur mit gegrilltem Deckel aus Edelstahl AISI 304 erhältlich. Optional: mechanische Zeitschaltuhr - Gitterabdeckung aus Edelstahl AISI 304.

RU Спиральный миксер "Hydraplus" с механической панелью управления, подъемной головкой и съемной чашей.
Машина для приготовления различных видов теста, особенно подходит для теста с высокой гидратацией finally до 90%. Конструкция покрыта антигравийной краской - детали, контактирующие с пищевыми продуктами, такие как чаша, спираль и стержень тестоделителя, выполнены из нержавеющей стали. Стандартная крышка из дымчатого поликарбоната, за исключением модели HYD50, поставляемой только с решетчатой крышкой из нержавеющей стали AISI 304.
Дополнительно: механический таймер - крышка-гриль из нержавеющей стали AISI 304.



GUARDA IL VIDEO
WATCH THE VIDEO



Motore Brushless con inverter
Brushless motor with inverter



Alta idratazione fino al 90%
High hydration up to 90%



Variatore di velocità fino a 250 rpm
Speed variator up to 250 rpm



	HYD12SRM	HYD18SRM	HYD25SRM	HYD38SRM	HYD50SRM
	2,4 kW (3,2 HP)		3,6 kW (4,8 HP)		4 kW (5,4 HP)
	230V/1N/50-60Hz				
	36 Kg/h	54 Kg/h	75 Kg/h	114 Kg/h	150 Kg/h
	12 Kg	18 Kg	25 Kg	38 Kg	50 Kg
	16 L (ø 320 x 210(h) mm)	22 L (ø 360 x 210(h) mm)	32 L (ø 400 x 260(h) mm)	42 L (ø 450 x 260(h) mm)	62 L (ø 500 x 310(h) mm)
	55±250 rpm				60±220 rpm
	639 x 336 x 750±932(h) mm	660 x 380 x 750±951(h) mm	769 x 420 x 864±1123(h) mm	800 x 474 x 879±1160(h) mm	941 x 520 x 1074±1393(h) mm
					
	65 Kg	67 Kg	104 Kg	112 Kg	186 Kg
	74 Kg	76 Kg	115 Kg	123 Kg	207 Kg
	700 x 460 x 890(h) mm		850 x 550 x 1055(h) mm		1055 x 600 x 1276(h) mm
	0,290 m³		0,490 m³		0,803 m³



Non utilizzabile con ruote o carrello
 Cannot be used with wheels or trolley
 Ne peut être utilisé avec roues ou chariot
 Kann nicht mit Rädern oder Wagen verwendet werden
 No se puede utilizar con ruedas o carro
 Невозможно использовать с колесами или тележкой

HYD12SLM
HYD18SLM-HYD25SLM
HYD38SLM-HYD50SLM

Impastatrice a spirale con testa sollevabile e vasca fissa



HYD25SLM



HYD12SLM

SPIRAL KNEADER
PETRIN A SPIRAL
SPIRALTEIGKNETMASCHINE
AMASADORA DE ESPIRAL
СПИРАЛЬНЫЙ ТЕСТОМЕС

**PANNELLO COMANDI MECCANICO
MECHANICAL CONTROL PANEL**

HydraPlus

IT Impastatrice a spirale "Hydraplus" con pannello comandi meccanico, testa sollevabile e vasca fissa. Macchina per realizzare diversi tipi di impasto, indicata soprattutto per impasti ad alta idratazione fino al 90%. Struttura rivestita con vernice antigraffio - parti a contatto con gli alimenti quali vasca, spirale ed asta spacca pasta sono in acciaio inox - microinterruttore di sicurezza su coperchio vasca. Coperchio in policarbonato fumè di serie tranne per il mod. HYD50 disponibile solo con coperchio grigliato in acciaio inox AISI 304.
Optional: timer meccanico - coperchio grigliato in acciaio inox AISI 304.

FR Mélangeur à spirale "Hydraplus" avec panneau de commande mécanique, tête relevable et cuve fixée.
Machine pour la fabrication de différents types de pâtes, particulièrement adaptée aux pâtes à haute hydratation finalement jusqu'à 90%. Structure recouverte de peinture anti-rayures - parties en contact avec les aliments telles que cuve, spirale et tige de séparation de la pâte en acier inox - micro-interrupteur de sécurité sur le couvercle de la cuve.
Couvercle en polycarbonate fumé en standard sauf pour le mod. HYD50 disponible uniquement avec couvercle grillagé en acier inox AISI 304.
En option: minuterie mécanique - couvercle à grille en acier inox AISI 304.

ES Amasadora espiral "Hydraplus" on panel de control mecánico, cabezal elevable y cuba fija.
Máquina para la elaboración de diferentes tipos de masas, especialmente indicada para masas de alta hidratación finalmente hasta el 90%. Estructura revestida con pintura antiarañazos - partes en contacto con los alimentos como cuba, espiral y varilla divisora de masa son de acero inoxidable - microinterruptor de seguridad en la tapa de la cuba. Tapa de policarbonato ahumado de serie excepto mod. HYD50 disponible sólo con tapa con rejilla de acero inoxidable AISI 304. Opcional: temporizador mecánico - tapa con rejilla de acero inoxidable AISI 304.

EN "Hydraplus" spiral kneader with mechanical control panel, liftable head and fixed bowl.
Machine for making different types of dough, especially suitable for high-hydration doughs up to 90%. Structure coated with scratch-proof paint - parts in contact with foodstuffs such as bowl, spiral and dough splitter rod are in stainless steel - safety microswitch on bowl lid. Smoked polycarbonate lid as standard except for mod. HYD50 available only with AISI 304 stainless steel gridded lid.
Optional: mechanical timer AISI 304 stainless steel gridded lid.

DE "Hydraplus"-Spiralknetter mit mechanischem Bedienfeld, anhebbaarem Kopf und fester Schüssel.
Maschine zur Herstellung verschiedener Teigsorten, besonders geeignet für Teige mit hohem Feuchtigkeitsgehalt bis zu 90%. Struktur mit kratzfester Farbe beschichtet - Teile, die mit Lebensmitteln in Berührung kommen, wie Schüssel, Spirale und Teigspaltstab, sind aus Edelstahl - Sicherheitsmikroschalter auf dem Schüsseldeckel. Deckel aus geräuchertem Polycarbonat als Standard, außer bei Mod. HYD50 nur mit gegrilltem Deckel aus Edelstahl AISI 304 erhältlich. Optional: mechanische Zeitschaltuhr - Gitterabdeckung aus Edelstahl AISI 304.

RU Спиральный миксер "Hydraplus" с механической панелью управления, подъемной головкой и фиксированной чашей.
Машина для приготовления различных видов теста, особенно подходит для теста с высокой гидратацией finally до 90%. Конструкция покрыта антигравийной краской - детали, контактирующие с пищевыми продуктами, такие как чаша, спираль и стержень тестоделителя, выполнены из нержавеющей стали. Стандартная крышка из дымчатого поликарбоната, за исключением модели HYD50, поставляемой только с решетчатой крышкой из нержавеющей стали AISI 304.
Дополнительно: механический таймер - крышка-гриль из нержавеющей стали AISI 304.



GUARDA IL VIDEO
WATCH THE VIDEO



Motore Brushless con inverter
Brushless motor with inverter



Alta idratazione fino al 90%
High hydration up to 90%



Variatore di velocità fino a 250 rpm
Speed variator up to 250 rpm

	HYD12SLM	HYD18SLM	HYD25SLM	HYD38SLM	HYD50SLM
	2,4 kW (3,2 HP)		3,6 kW (4,8 HP)		4 kW (5,4 HP)
	230V/1N/50-60Hz				
	36 Kg/h	54 Kg/h	75 Kg/h	114 Kg/h	150 Kg/h
	12 Kg	18 Kg	25 Kg	38 Kg	50 Kg
	16 L (ø 320 x 210(h) mm)	22 L (ø 360 x 210(h) mm)	32 L (ø 400 x 260(h) mm)	42 L (ø 450 x 260(h) mm)	62 L (ø 500 x 310(h) mm)
	55±250 rpm				60±220 rpm
	639 x 336 x 750±932(h) mm	660 x 380 x 750±951(h) mm	769 x 420 x 864±1123(h) mm	800 x 474 x 879±1160(h) mm	941 x 520 x 1074±1393(h) mm
					
	62 Kg	64 Kg	97 Kg	106 Kg	172 Kg
	71 Kg	73 Kg	108 Kg	117 Kg	193 Kg
	700 x 460 x 890(h) mm		850 x 550 x 1055(h) mm		1055 x 600 x 1276(h) mm
	0,290 m³		0,490 m³		0,803 m³



Non utilizzabile con ruote o carrello
 Cannot be used with wheels or trolley
 Ne peut être utilisé avec roues ou chariot
 Kann nicht mit Rädern oder Wagen verwendet werden
 No se puede utilizar con ruedas o carro
 Невозможно использовать с колесами или тележкой

OPTIONAL



HYD12SBM
HYD18SBM-HYD25SBM
HYD38SBM-HYD50SBM



HYD12SBM



HYD50SBGM

**PANNELLO COMANDI MECCANICO
MECHANICAL CONTROL PANEL**

Impastatrice a spirale
con testa fissa

SPIRAL KNEADER
PETRIN A SPIRAL
SPIRALTEIGKNETMASCHINE
AMASADORA DE ESPIRAL
СПИРАЛЬНЫЙ ТЕСТОМЕС

IT Impastatrice a spirale "Hydraplus" con pannello comandi meccanico e testa fissa. Macchina per realizzare diversi tipi di impasto, indicata soprattutto per impasti ad alta idratazione fino al 90%. Struttura rivestita con vernice antigraffio - parti a contatto con gli alimenti quali vasca, spirale ed asta spacca pasta sono in acciaio inox - microinterruttore di sicurezza su coperchio vasca. Coperchio in policarbonato fumè di serie tranne per il mod. HYD50 disponibile solo con coperchio grigliato in acciaio inox AISI 304.
Optional: timer meccanico - coperchio grigliato in acciaio inox AISI 304.

FR Mélangeur à spirale "Hydraplus" avec panneau de commande mécanique et tête fixée.
Machine pour la fabrication de différents types de pâtes, particulièrement adaptée aux pâtes à haute hydratation finalement jusqu'à 90%. Structure recouverte de peinture anti-rayures - parties en contact avec les aliments telles que cuve, spirale et tige de séparation de la pâte en acier inox - micro-interrupteur de sécurité sur le couvercle de la cuve. Couvercle en polycarbonate fumé en standard sauf pour le mod. HYD50 disponible uniquement avec couvercle grillagé en acier inox AISI 304.
En option: minuterie mécanique - couvercle à grille en acier inox AISI 304.

ES Amasadora espiral "Hydraplus" con panel de control mecánico y cabezal fijo. Máquina para la elaboración de diferentes tipos de masas, especialmente indicada para masas de alta hidratación finalmente hasta el 90%. Estructura revestida con pintura antiarañazos - partes en contacto con los alimentos como cuba, espiral y varilla divisora de masa son de acero inoxidable - microinterruptor de seguridad en la tapa de la cuba. Tapa de policarbonato ahumado de serie excepto mod. HYD50 disponible sólo con tapa con rejilla de acero inoxidable AISI 304.
Opcional: temporizador mecánico - tapa con rejilla de acero inoxidable AISI 304.

EN "Hydraplus" spiral kneader with mechanical control panel and fixed head. Machine for making different types of dough, especially suitable for high-hydration doughs up to 90%. Structure coated with scratch-proof paint - parts in contact with foodstuffs such as bowl, spiral and dough splitter rod are in stainless steel - safety microswitch on bowl lid. Smoked polycarbonate lid as standard except for mod. HYD50 available only with AISI 304 stainless steel gridded lid.
Optional: mechanical timer AISI 304 stainless steel gridded lid.

DE "Hydraplus"-Spiralkneiter mit mechanischem Bedienfeld und festem Kopf. Maschine zur Herstellung verschiedener Teigsorten, besonders geeignet für Teige mit hohem Feuchtigkeitsgehalt bis zu 90%. Struktur mit kratzfester Farbe beschichtet - Teile, die mit Lebensmitteln in Berührung kommen, wie Schüssel, Spirale und Teigspaltstab, sind aus Edelstahl - Sicherheitsmikroschalter auf dem Schüsseldeckel. Deckel aus geräuchertem Polycarbonat als Standard, außer bei Mod. HYD50 nur mit gegrilltem Deckel aus Edelstahl AISI 304 erhältlich.
Optional: mechanische Zeitschaltuhr - Gitterabdeckung aus Edelstahl AISI 304.

RU Спиральный миксер "Hydraplus" с цифровой панелью управления и фиксированной головкой. Машина для приготовления различных видов теста, особенно подходит для теста с высокой гидратацией finally до 90%. Конструкция покрыта антигравийной краской - детали, контактирующие с пищевыми продуктами, такие как чаша, спираль и стержень тестоделителя, выполнены из нержавеющей стали. Стандартная крышка из дымчатого поликарбоната, за исключением модели HYD50, поставляемой только с решетчатой крышкой из нержавеющей стали AISI 304.
Дополнительно: механический таймер - крышка-гриль из нержавеющей стали AISI 304.



GUARDA IL VIDEO
WATCH THE VIDEO



Motore Brushless con inverter
Brushless motor with inverter











Alta idratazione fino al 90%
High hydration up to 90%



Variatore di velocità fino a 250 rpm
Speed variator up to 250 rpm



	HYD12SBM	HYD18SBM	HYD25SBM	HYD38SBM	HYD50SBM
	2,4 kW (3,2 HP)		3,6 kW (4,8 HP)		4 kW (5,4 HP)
	230V/1N/50-60Hz				
	36 Kg/h	54 Kg/h	75 Kg/h	114 Kg/h	150 Kg/h
	12 Kg	18 Kg	25 Kg	38 Kg	50 Kg
	16 L (ø 320 x 210(h) mm)	22 L (ø 360 x 210(h) mm)	32 L (ø 400 x 260(h) mm)	42 L (ø 450 x 260(h) mm)	62 L (ø 500 x 310(h) mm)
	55±250 rpm				60±220 rpm
	639 x 336 x 750±932(h) mm	660 x 380 x 750±951(h) mm	769 x 420 x 864±1123(h) mm	800 x 474 x 879±1160(h) mm	941 x 520 x 1074±1393(h) mm
					
	58 Kg	60 Kg	92 Kg	100 Kg	160 Kg
	67 Kg	69 Kg	103 Kg	111 Kg	181 Kg
	700 x 460 x 890(h) mm		850 x 550 x 1055(h) mm		1055 x 600 x 1276(h) mm
	0,290 m³		0,490 m³		0,803 m³



Non utilizzabile con ruote o carrello
 Cannot be used with wheels or trolley
 Ne peut être utilisé avec roues ou chariot
 Kann nicht mit Rädern oder Wagen verwendet werden
 No se puede utilizar con ruedas o carro
 Невозможно использовать с колесами или тележкой

Optional

ACCESSORIES
ACCESSOIRES
ZUBEHÖR
ACCESORIOS
AKCECCYAPЫ



Timer meccanico - Mechanical timer
Minuterie mécanique - Mechanischer Timer
Temporizador mecánico - Механический таймер

HYD 12-18-25-38-50



COPERCHIO GRIGLIATO
STAINLESS STEEL GRIDDED LID

Coperchio grigliato inox - Stainless steel gridded lid
Couvercle grillé en acier inox - Gitterdeckel aus Edelstahl
Tapa con red de acero inoxidable
Поставляется с крышкой из нержавеющей стали

HYD 12-18-25-38



MANIGLIE ESTRAZIONE PENTOLA
POT EXTRACTION HANDLES

Maniglie estrazione pentola - Pot extraction handles
Poignées d'extraction de la cuve - Schüsselausziehgriffe
Manijas para extraer el bol - Ручки для извлечения дежи

ACMANIM

HYD 12-18-25 SR

ACMANIM3850

HYD 38-50 SR

HYD12SRD
HYD18SRD-HYD25SRD
HYD38SRD-HYD50SRD

New



HYD12SRD



HYD18SRD

**PANNELLO COMANDI DIGITALE
DIGITAL CONTROL PANEL**

Impastatrice a spirale
con testa sollevabile e vasca estraibile

SPIRAL KNEADER
PETRIN A SPIRAL
SPIRALTEIGKNETMASCHINE
AMASADORA DE ESPIRAL
СПИРАЛЬНЫЙ ТЕСТОМЕС

IT Impastatrice a spirale "Hydraplus" con pannello comandi digitale, testa sollevabile e vasca estraibile.
Macchina per realizzare diversi tipi di impasto, indicata soprattutto per impasti ad alta idratazione fino al 90%. Struttura rivestita con vernice antigraffio - parti a contatto con gli alimenti quali vasca, spirale ed asta spacca pasta sono in acciaio inox - microinterruttore di sicurezza su coperchio vasca - timer digitale. Coperchio in policarbonato fumè di serie tranne per il mod. HYD50 disponibile solo con coperchio grigliato in acciaio inox AISI 304.
Optional: sensore termico a infrarossi - inversione di marcia (non disponibile per il modello HYD50) - coperchio grigliato in acciaio inox AISI 304.

FR Mélangeur à spirale "Hydraplus" avec panneau de commande numérique, tête relevable et cuve amovible.
Machine pour la fabrication de différents types de pâtes, particulièrement adaptée aux pâtes à haute hydratation finalement jusqu'à 90%. Structure recouverte de peinture anti-rayures - parties en contact avec les aliments telles que cuve, spirale et tige de séparation de la pâte en acier inox - micro-interrupteur de sécurité sur le couvercle de la cuve. Couvercle en polycarbonate fumé en standard sauf pour le mod. HYD50 disponible uniquement avec couvercle grillagé en acier inox AISI 304.
En option: capteur thermique à infrarouge - marche inverse (pas disponible pour le modèle HYD50) - couvercle à grille en acier inox AISI 304.

ES Amasadora espiral "Hydraplus" con panel de control digital, cabezal elevable y cuba extraíble
Máquina para la elaboración de diferentes tipos de masas, especialmente indicada para masas de alta hidratación finalmente hasta el 90%. Estructura revestida con pintura antiarañazos - partes en contacto con los alimentos como cuba, espiral y varilla divisora de masa son de acero inoxidable - microinterruptor de seguridad en la tapa de la cuba. Tapa de policarbonato ahumado de serie excepto mod. HYD50 disponible sólo con tapa con rejilla de acero inoxidable AISI 304.
Opcional: sensor térmico infrarrojo - marcha atrás (no disponible para HYD50) - Tapa con rejilla de acero inoxidable AISI 304.

EN "Hydraplus" spiral kneader with digital control panel, liftable head and removable bowl.
Machine for making different types of dough, especially suitable for high-hydration doughs up to 90%. Structure coated with scratch-proof paint - parts in contact with foodstuffs such as bowl, spiral and dough splitter rod are in stainless steel - safety microswitch on bowl lid. Smoked polycarbonate lid as standard except for mod. HYD50 available only with AISI 304 stainless steel gridded lid.
Optional: infrared thermal sensor - reverse gear (not available for HYD50 model) - AISI 304 stainless steel gridded lid.

DE "Hydraplus"-Spiralknetter mit digitalem Bedienfeld, anhebbarer Kopf und abnehmbarer Schüssel.
Maschine zur Herstellung verschiedener Teigsorten, besonders geeignet für Teige mit hohem Feuchtigkeitsgehalt bis zu 90%. Struktur mit kratzfester Farbe beschichtet - Teile, die mit Lebensmitteln in Berührung kommen, wie Schüssel, Spirale und Teigspaltstab, sind aus Edelstahl - Sicherheitsmikroschalter auf dem Schüsseldeckel. Deckel aus geräuchertem Polycarbonat als Standard, außer bei Mod. HYD50 nur mit gegrilltem Deckel aus Edelstahl AISI 304 erhältlich.
Optional: Infrarot-Wärmesensor - Rückwärtsgang (nicht verfügbar für Modell HYD50) - Gitterabdeckung aus Edelstahl AISI 304.

RU Спиральный миксер "Hydraplus" с цифровой панелью управления, подъемной головкой и съемной чашей.
Машина для приготовления различных видов теста, особенно подходит для теста с высокой гидратацией finally до 90%. Конструкция покрыта антигравийной краской - детали, контактирующие с пищевыми продуктами, такие как чаша, спираль и стержень тестоделителя, выполнены из нержавеющей стали - предохранительный микровыключатель на крышке чаши. Стандартная крышка из дымчатого поликарбоната, за исключением модели HYD50, поставляемой только с решетчатой крышкой из нержавеющей стали AISI 304. Дополнительно: инфракрасный термодатчик - реверсивный режим (недоступен для HYD50) - крышка решетки из нержавеющей стали AISI 304.



Alta idratazione fino al 90%
High hydration up to 90%



Motore Brushless con inverter
Brushless motor with inverter



GUARDA IL VIDEO
WATCH THE VIDEO

















Timer digitale
Digital timer



Variatore di velocità fino a 250 rpm
Speed variator up to 250 rpm



	HYD12SRD	HYD18SRD	HYD25SRD	HYD38SRD	HYD50SRD
	2,4 kW (3,2 HP)		3,6 kW (4,8 HP)		4 kW (5,4 HP)
	230V/1N/50-60Hz				
	36 Kg/h	54 Kg/h	75 Kg/h	114 Kg/h	150 Kg/h
	12 Kg	18 Kg	25 Kg	38 Kg	50 Kg
	16 L (ø 320 x 210(h) mm)	22 L (ø 360 x 210(h) mm)	32 L (ø 400 x 260(h) mm)	42 L (ø 450 x 260(h) mm)	62 L (ø 500 x 310(h) mm)
	55±250 rpm				60±220 rpm
	Digitale - Digital - Цифровой 0÷99'				
	639 x 336 x 750±932(h) mm	660 x 380 x 750±951(h) mm	769 x 420 x 864±1123(h) mm	800 x 474 x 879±1160(h) mm	941 x 520 x 1074±1393(h) mm
					
	65 Kg	67 Kg	104 Kg	112 Kg	186 Kg
	74 Kg	76 Kg	115 Kg	123 Kg	207 Kg
	700 x 460 x 890(h) mm		850 x 550 x 1055(h) mm		1055 x 600 x 1276(h) mm
	0,290 m³		0,490 m³		0,803 m³



Non utilizzabile con ruote o carrello
 Cannot be used with wheels or trolley
 Ne peut être utilisé avec roues ou chariot
 Kann nicht mit Rädern oder Wagen verwendet werden
 No se puede utilizar con ruedas o carro
 Невозможно использовать с колесами или тележкой

Impastatrice a spirale con testa sollevabile e vasca fissa

HYD12SLD
HYD18SLD-HYD25SLD
HYD38SLD-HYD50SLD



HYD25SLD



HYD12SLD

SPIRAL KNEADER
PETRIN A SPIRAL
SPIRALTEIGKNETMASCHINE
AMASADORA DE ESPIRAL
СПИРАЛЬНЫЙ ТЕСТОМЕС

**PANNELLO COMANDI DIGITALE
DIGITAL CONTROL PANEL**

HydraPlus



IT Impastatrice a spirale "Hydraplus" con pannello comandi digitale, testa sollevabile e vasca fissa.
Macchina per realizzare diversi tipi di impasto, indicata soprattutto per impasti ad alta idratazione fino al 90%. Struttura rivestita con vernice antigraffio - parti a contatto con gli alimenti quali vasca, spirale ed asta spacca pasta sono in acciaio inox - microinterruttore di sicurezza su coperchio vasca - timer digitale. Coperchio in policarbonato fumè di serie tranne per il mod. HYD50 disponibile solo con coperchio grigliato in acciaio inox AISI 304.
Optional: sensore termico a infrarossi - inversione di marcia (non disponibile per il modello HYD50) - coperchio grigliato in acciaio inox AISI 304.

FR Mélangeur à spirale "Hydraplus" avec panneau de commande numérique, tête relevable et cuve fixée.
Machine pour la fabrication de différents types de pâtes, particulièrement adaptée aux pâtes à haute hydratation finalement jusqu'à 90%. Structure recouverte de peinture anti-rayures - parties en contact avec les aliments telles que cuve, spirale et tige de séparation de la pâte en acier inox - micro-interrupteur de sécurité sur le couvercle de la cuve. Couvercle en polycarbonate fumé en standard sauf pour le mod. HYD50 disponible uniquement avec couvercle grillagé en acier inox AISI 304.
En option: capteur thermique à infrarouge - marche inverse (pas disponible pour le modèle HYD50) - couvercle à grille en acier inox AISI 304.

ES Amasadora espiral "Hydraplus" con panel de control digital, cabezal elevable y cuba fija.
Máquina para la elaboración de diferentes tipos de masas, especialmente indicada para masas de alta hidratación finalmente hasta el 90%. Estructura revestida con pintura antiarañazos - partes en contacto con los alimentos como cuba, espiral y varilla divisora de masa son de acero inoxidable - microinterruptor de seguridad en la tapa de la cuba. Tapa de policarbonato ahumado de serie excepto mod. HYD50 disponible sólo con tapa con rejilla de acero inoxidable AISI 304.
Opcional: sensor térmico infrarrojo - marcha atrás (no disponible para HYD50) - tapa con rejilla de acero inoxidable AISI 304.

EN "Hydraplus" spiral kneader with digital control panel, liftable head and fixed bowl.
Machine for making different types of dough, especially suitable for high-hydration doughs up to 90%. Structure coated with scratch-proof paint - parts in contact with foodstuffs such as bowl, spiral and dough splitter rod are in stainless steel - safety microswitch on bowl lid. Smoked polycarbonate lid as standard except for mod. HYD50 available only with AISI 304 stainless steel gridded lid.
Optional: infrared thermal sensor - reverse gear (not available for HYD50 model) - AISI 304 stainless steel gridded lid.

DE "Hydraplus"-Spiralkneiter mit digitalem Bedienfeld, anhebbaarem Kopf und fester Schüssel.
Maschine zur Herstellung verschiedener Teigsorten, besonders geeignet für Teige mit hohem Feuchtigkeitsgehalt bis zu 90%. Struktur mit kratzfester Farbe beschichtet - Teile, die mit Lebensmitteln in Berührung kommen, wie Schüssel, Spirale und Teigspaltstab, sind aus Edelstahl - Sicherheitsmikroschalter auf dem Schüsseldeckel. Deckel aus geräuchertem Polycarbonat als Standard, außer bei Mod. HYD50 nur mit gegrilltem Deckel aus Edelstahl AISI 304 erhältlich.
Optional: Infrarot-Wärmesensor - Rückwärtsgang (nicht verfügbar für Modell HYD50) - Gitterabdeckung aus Edelstahl AISI 304.

RU Спиральный миксер "Hydraplus" с цифровой панелью управления, подъемной головкой и неподвижной чашей.
Машина для приготовления различных видов теста, особенно подходит для теста с высокой гидратацией finally до 90%. Конструкция покрыта антигравийной краской - детали, контактирующие с пищевыми продуктами, такие как чаша, спираль и стержень тестоделителя, выполнены из нержавеющей стали - предохранительный микровыключатель на крышке чаши. Стандартная крышка из дымчатого поликарбоната, за исключением модели HYD50, поставляемой только с решетчатой крышкой из нержавеющей стали AISI 304. Дополнительно: инфракрасный термодатчик - реверсивный режим (недоступен для HYD50) - крышка решетки из нержавеющей стали AISI 304.



Alta idratazione fino al 90%
High hydration up to 90%



Motore Brushless con inverter
Brushless motor with inverter

















GUARDA IL VIDEO
WATCH THE VIDEO



Timer digitale
Digital timer



Variatore di velocità fino a 250 rpm
Speed variator up to 250 rpm

	HYD12SLD	HYD18SLD	HYD25SLD	HYD38SLD	HYD50SLD
	2,4 kW (3,2 HP)		3,6 kW (4,8 HP)		4 kW (5,4 HP)
	230V/1N/50-60Hz				
	36 Kg/h	54 Kg/h	75 Kg/h	114 Kg/h	150 Kg/h
	12 Kg	18 Kg	25 Kg	38 Kg	50 Kg
	16 L (ø 320 x 210(h) mm)	22 L (ø 360 x 210(h) mm)	32 L (ø 400 x 260(h) mm)	42 L (ø 450 x 260(h) mm)	62 L (ø 500 x 310(h) mm)
	55÷250 rpm				60÷220 rpm
	Digitale - Digital - Цифровой 0÷99'				
	639 x 336 x 750÷932(h) mm	660 x 380 x 750÷951(h) mm	769 x 420 x 864÷1123(h) mm	800 x 474 x 879÷1160(h) mm	941 x 520 x 1074÷1393(h) mm
					
	62 Kg	64 Kg	97 Kg	106 Kg	172 Kg
	71 Kg	73 Kg	108 Kg	117 Kg	193 Kg
	700 x 460 x 890(h) mm		850 x 550 x 1055(h) mm		1055 x 600 x 1276(h) mm
	0,290 m³		0,490 m³		0,803 m³



Non utilizzabile con ruote o carrello
 Cannot be used with wheels or trolley
 Ne peut être utilisé avec roues ou chariot
 Kann nicht mit Rädern oder Wagen verwendet werden
 No se puede utilizar con ruedas o carro
 Невозможно использовать с колесами или тележкой

OPTIONAL



HydraPlus



HYD12SBD
HYD18SBD-HYD25SBD
HYD38SBD-HYD50SBD

New



HYD12SBD



OPTIONAL
COPERCHIO GRIGLIATO
GRID LID

HYD38SBDG

PANNELLO COMANDI DIGITALE
DIGITAL CONTROL PANEL

Impastatrice a spirale
con testa fissa

SPIRAL KNEADER
PETRIN A SPIRAL
SPIRALTEIGKNETMASCHINE
AMASADORA DE ESPIRAL
СПИРАЛЬНЫЙ ТЕСТОМЕС

IT Impastatrice a spirale "Hydraplus" con pannello comandi digitale e testa fissa. Macchina per realizzare diversi tipi di impasto, indicata soprattutto per impasti ad alta idratazione fino al 90%. Struttura rivestita con vernice antigraffio - parti a contatto con gli alimenti quali vasca, spirale ed asta spacca pasta sono in acciaio inox - microinterruttore di sicurezza su coperchio vasca - timer digitale. Coperchio in polycarbonato fumè di serie tranne per il mod. HYD50 disponibile solo con coperchio grigliato in acciaio inox AISI 304.
Optional: sensore termico a infrarossi - inversione di marcia (non disponibile per il modello HYD50) - coperchio grigliato in acciaio inox AISI 304.

FR Mélangeur à spirale "Hydraplus" avec panneau de commande numérique et tête fixée. Machine pour la fabrication de différents types de pâtes, particulièrement adaptée aux pâtes à haute hydratation finalement jusqu'à 90%. Structure recouverte de peinture anti-rayures - parties en contact avec les aliments telles que cuve, spirale et tige de séparation de la pâte en acier inox - micro-interrupteur de sécurité sur le couvercle de la cuve. Couvercle en polycarbonate fumé en standard sauf pour le mod. HYD50 disponible uniquement avec couvercle grillagé en acier inox AISI 304.
En option: capteur thermique à infrarouge - marche inverse (pas disponible pour le modèle HYD50) - couvercle à grille en acier inox AISI 304.

ES Amasadora espiral "Hydraplus" con panel de control digital y cabezal fijo. Máquina para la elaboración de diferentes tipos de masas, especialmente indicada para masas de alta hidratación finalmente hasta el 90%. Estructura revestida con pintura antiarañazos - partes en contacto con los alimentos como cuba, espiral y varilla divisora de masa son de acero inoxidable - microinterruptor de seguridad en la tapa de la cuba. Tapa de polycarbonato ahumado de serie excepto mod. HYD50 disponible sólo con tapa con rejilla de acero inoxidable AISI 304.
Opcional: sensor térmico infrarrojo - marcha atrás (no disponible para HYD50) - tapa con rejilla de acero inoxidable AISI 304.

EN "Hydraplus" spiral kneader with digital control panel and fixed head. Machine for making different types of dough, especially suitable for high-hydration doughs up to 90%. Structure coated with scratch-proof paint - parts in contact with foodstuffs such as bowl, spiral and dough splitter rod are in stainless steel - safety microswitch on bowl lid. Smoked polycarbonate lid as standard except for mod. HYD50 available only with AISI 304 stainless steel gridded lid.
Optional: infrared thermal sensor - reverse gear (not available for HYD50 model) - AISI 304 stainless steel gridded lid.

DE "Hydraplus"-Spiralkneiter mit digitalem Bedienfeld und festem Kopf. Maschine zur Herstellung verschiedener Teigsorten, besonders geeignet für Teige mit hohem Feuchtigkeitsgehalt bis zu 90%. Struktur mit kratzfester Farbe beschichtet - Teile, die mit Lebensmitteln in Berührung kommen, wie Schüssel, Spirale und Teigspaltstab, sind aus Edelstahl - Sicherheitsmikroschalter auf dem Schüsseldeckel. Deckel aus geräuchertem Polycarbonat als Standard, außer bei Mod. HYD50 nur mit gegrilltem Deckel aus Edelstahl AISI 304 erhältlich.
Optional: Infrarot-Wärmesensor - Rückwärtsgang (nicht verfügbar für Modell HYD50) - Gitterabdeckung aus Edelstahl AISI 304.

RU Спиральный миксер "Hydraplus" с цифровой панелью управления и фиксированной головкой. Машина для приготовления различных видов теста, особенно подходит для теста с высокой гидратацией finally до 90%. Конструкция покрыта антигравийной краской - детали, контактирующие с пищевыми продуктами, такие как чаша, спираль и стержень тестоделителя, выполнены из нержавеющей стали - предохранительный микровыключатель на крышке чаши. Стандартная крышка из дымчатого поликарбоната, за исключением модели HYD50, поставляемой только с решетчатой крышкой из нержавеющей стали AISI 304.
Дополнительно: инфракрасный термодатчик - реверсивный режим (недоступен для HYD50) - крышка решетки из нержавеющей стали AISI 304.



Alta idratazione fino al 90%
High hydration up to 90%



Motore Brushless con inverter
Brushless motor with inverter



GUARDA IL VIDEO
WATCH THE VIDEO



Timer digitale
Digital timer



Variatore di velocità fino a 250 rpm
Speed variator up to 250 rpm















OPTIONAL



149

New

147

	HYD12SBD	HYD18SBD	HYD25SBD	HYD38SBD	HYD50SBD
	2,4 kW (3,2 HP)		3,6 kW (4,8 HP)		4 kW (5,4 HP)
	230V/1N/50-60Hz				
	36 Kg/h	54 Kg/h	75 Kg/h	114 Kg/h	150 Kg/h
	12 Kg	18 Kg	25 Kg	38 Kg	50 Kg
	16 L (ø 320 x 210(h) mm)	22 L (ø 360 x 210(h) mm)	32 L (ø 400 x 260(h) mm)	42 L (ø 450 x 260(h) mm)	62 L (ø 500 x 310(h) mm)
	55÷250 rpm				60÷220 rpm
	Digitale - Digital - Цифровой 0÷99'				
	639 x 336 x 750÷932(h) mm	660 x 380 x 750÷951(h) mm	769 x 420 x 864÷1123(h) mm	800 x 474 x 879÷1160(h) mm	941 x 520 x 1074÷1393(h) mm
					
	58 Kg	60 Kg	92 Kg	100 Kg	160 Kg
	67 Kg	69 Kg	103 Kg	111 Kg	181 Kg
	700 x 460 x 890(h) mm		850 x 550 x 1055(h) mm		1055 x 600 x 1276(h) mm
	0,290 m³		0,490 m³		0,803 m³



Non utilizzabile con ruote o carrello
 Cannot be used with wheels or trolley
 Ne peut être utilisé avec roues ou chariot
 Kann nicht mit Rädern oder Wagen verwendet werden
 No se puede utilizar con ruedas o carro
 Невозможно использовать с колесами или тележкой

Optional

ACCESSORIES
ACCESSOIRES
ZUBEHÖR
ACCESORIOS
AKCECCYAPЫ

	Coperchio grigliato inox - Stainless steel gridded lid Couvercle grillé en acier inox - Gitterdeckel aus Edelstahl Tapa con red de acero inoxidable Поставляется с крышкой из нержавеющей стали
	HYD 12-18-25-38

	Maniglie estrazione pentola - Pot extraction handles Poignées d'extraction de la cuve - Schüsselauszehgriffe Manijas para extraer el bol - Ручки для извлечения дежи
ACMANIM	HYD 12-18-25 SR
ACMANIM3850	HYD 38-50 SR

	Sensore termico ad infrarossi - Infrared thermal sensor Capteur thermique à infrarouge - Sensor térmico infrarrojo Infrarot-Wärmesensor - инфракрасный термодатчик
	HYD 12-18-25-38-50
	Con pannello touch - With touch panel С сенсорной панелью
	Con pannello digitale - With digital panel С цифровой панелью

	Sensore termico ad infrarossi + Inversione di marcia Infrared thermal sensor + Reverse gear Capteur thermique à infrarouge + Marche inverse Sensor térmico infrarrojo + Marcha atrás Infrarot-Wärmesensor + Rückwärtsgang инфракрасный термодатчик + реверсивный режим
	HYD 12-18-25-38*

*ATTENZIONE! La funzione inversione di marcia è utile con pre-impasto (biga). L'utilizzo della funzione inversione di marcia riduce la capacità di qualsiasi tipo di impasto come da tabella che segue:

*IMPORTANT! The reverse function is useful with pre-dough (biga). Using the reverse function reduces the capacity of any type of dough as shown in the table below:

*ВНИМАНИЕ! Функция реверса полезна при предварительном замешивании теста (бига). Использование функции реверса снижает производительность любого типа теста, как показано в следующей таблице:

	HYD12	HYD18	HYD25	HYD38
	5 Kg Max.	7 Kg Max.	10 Kg Max.	15 Kg Max.

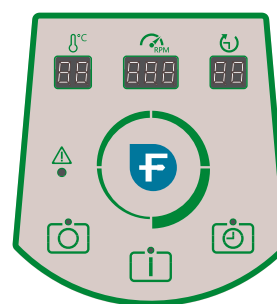

Pannello touch
Touch panel



Pannello digitale
Digital panel





Pannello digitale
+ Inversione
Digital panel + Reverse

BERTA7-BERTA15
BERTA25-BERTA35



GUARDA IL VIDEO
WATCH THE VIDEO



Made in
Romagna



MADE IN ITALY

Impastatrice Berta

BERTA KNEADER
BERTA PETRIN
BERTA TEIGKNETMASCHINE
BERTA AMASADORA
BERTA TECTOMEK

Berta[®]

fimar[®]

IT Macchina ideale per impasti a bassa idratazione, ricchi di grassi come: piada, taralli, grissini o pizza in teglia. Ottimi risultati anche per impasti all'uovo. L'impastatrice "Berta" grazie all'innovativo sistema di utensile a gancio riproduce il movimento della lavorazione a mano e non altera la temperatura dell'impasto migliorandone l'ossigenazione e la digeribilità; i tempi di lavorazione dell'impasto sono dimezzati rispetto alle tradizionali impastatrici. Struttura rivestita con vernice antigraffio - vasca, utensile e coperchio grigliato in acciaio inox AISI 304. Optional: 2° velocità solo su modelli trifase, timer meccanico e ruote.

FR Machine idéale pour les pâtes à faible hydratation et à forte teneur en matières grasses telles que piada, taralli, gressins, pan pizza, elle peut également être utilisée pour les pâtes aux œufs. "Berta" utilise le système innovant d'outils à crochets qui reproduit le mouvement du travail manuel et n'altère pas la température de la pâte, améliorant ainsi l'oxygénation et la digestibilité. Le temps de travail de la pâte est réduit de moitié par rapport aux pétrins traditionnel. Corps recouvert de peinture anti-rayures - cuve, outil et couvercle à grille en acier inox AISI 304. En option: 2ème vitesse uniquement sur les modèles triphasés, minuterie mécanique et roues.

ES Máquina ideal para masas de baja hidratación y alto contenido en grasa como piada, taralli, palitos de pan, pizza en molde, también se puede utilizar para masas al huevo. "Berta" utiliza el innovador sistema de herramienta de gancho que reproduce el movimiento del trabajo manual sin alterar la temperatura de la masa, mejorando la oxigenación y la digestibilidad. Los tiempos de procesamiento de la masa se reducen a la mitad en comparación con las amasadoras tradicionales. Estructura recubierta de pintura antiarañazos - bol, útil y tapa en acero inoxidable AISI 304. Opcional: 2ª velocidad sólo en modelos trifásicos, temporizador mecánico y ruedas.

EN The ideal machine for low-hydration and high-fat doughs such as piada, taralli, breadsticks, pizza in trays, also suitable for egg mixtures. "Berta" uses the innovative hook tool system, which reproduces the movement of manual kneading without altering the temperature of the dough, improving its oxygenation and digestibility. Dough processing times are halved compared to traditional kneading machines. Casing coated with scratch-proof paint - bowl, tool and grilled lid in stainless steel AISI 304. Optional: 2nd speed only on three-phase models, mechanical timer and wheels.

DE Die ideale Maschine für feuchtigkeitsarme und fettreiche Teige wie Piada, Taralli, Brotstangen, Pfannenzpizza, sie kann auch für Eierteige verwendet werden. "Berta" verwendet das innovative Hakenwerkzeugsystem, das die Bewegung der Handarbeit nachbildet, ohne die Temperatur des Teigs zu verändern, wodurch die Sauerstoffzufuhr und die Verdaulichkeit verbessert werden. Die Teigverarbeitungszeiten halbieren sich im Vergleich zu herkömmlichen Knetmaschinen. Gehäuse mit kratzfester Lackierung beschichtet - Behälter, Werkzeug und Deckel aus Edelstahl AISI 304. Optional: Zweite Geschwindigkeit nur bei Drehstrommodellen, mechanische Zeitschaltuhr und Rädern.

RU Машина идеальна для приготовления теста с низким содержанием влаги, богатого жирами, например, для приготовления лепешек (пиада), сухек (таралли), хлебных палочек или пиццы на сковороде. Оптимальна также для приготовления яичного теста. Благодаря инновационной крюковой системе, тестомес "Berta" воспроизводит движения ручного замеса без изменения температуры теста, насыщая его кислородом и улучшая усвояемость. Время приготовления теста сокращается вдвое по сравнению с традиционными миксерами. Конструкция покрыта антицарапанной краской - бак, инструмент и крышка из нержавеющей стали AISI 304. Опционально: 2-я скорость только для трехфазных моделей, механический таймер и колеса.



INNOVATIVO SISTEMA DI UTENSILE A GANCIO
THE INNOVATIVE HOOK TOOL SYSTEM

Timer meccanico - Mechanical timer
Minuterie mécanique - Mechanischer Timer
Temporizador mecánico - Механический таймер

KITRUOBERTA

Kit ruote - Set of wheels - Kit de roues
Rädersatz - Juego de ruedas - Набор колёс

	BERTA7	BERTA15	BERTA25	BERTA35
	0,37 kW (1 PH) 0,55/0,37 kW (3 PH) 2nd speed (optional)	0,55 kW (1 PH - 3 PH) 0,75/0,55 kW 2nd speed (optional)	0,9 kW (1 PH) - 0,75 kW (3 PH) 0,75/1,1 kW 2nd speed (optional)	1,1 kW (1 PH) - 0,75 kW (3 PH) 0,75/1,1 kW 2nd speed (optional)
	230-400V/3N/50Hz			
	230V/1N/50Hz			-
	7 Kg	15 Kg	25 Kg	35 Kg
	260 x 200 - 10 L	360 x 210 - 20 L	400 x 260 - 32 L	450 x 260 - 42 L
	35 rpm 35 - 70 rpm - 2nd speed (optional)	28 rpm 28 - 56 rpm - 2nd speed (optional)	23 rpm 23 - 46 rpm - 2nd speed (optional)	
	315 x 480 x 700(h) mm	410 x 580 x 755(h) mm	470 x 625 x 805(h) mm	520 x 675 x 805(h) mm
				
	39 Kg	51 Kg	61,5 Kg	68,5 Kg
	47,5 Kg	59,5 Kg	72 Kg	79 Kg
	460 x 700 x 860(h) mm		550 x 850 x 1060(h) mm	
	0,276 m³		0,495 m³	

Optional 2nd speed - 2-я скорость опционально (3 PH)

Special Voltages - Разное питающее напряжение

BERTA7

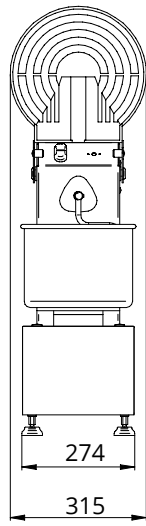
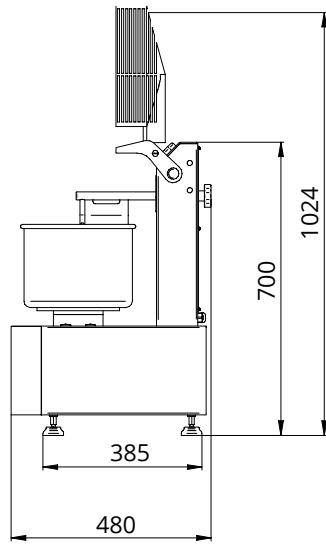

BERTA15

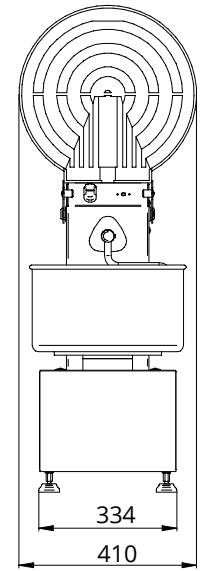
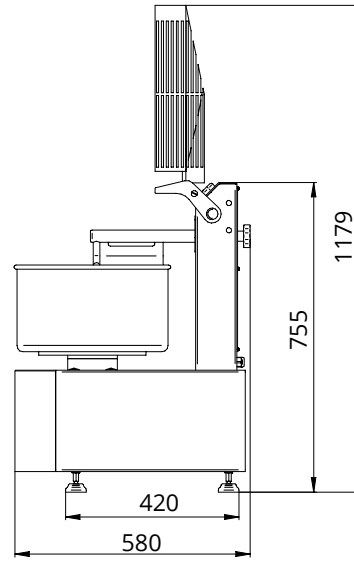

BERTA25

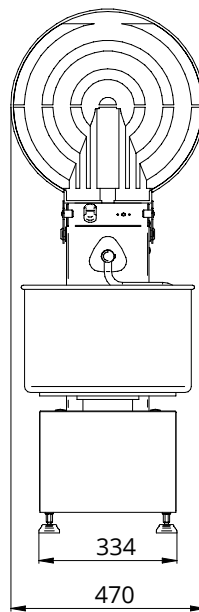
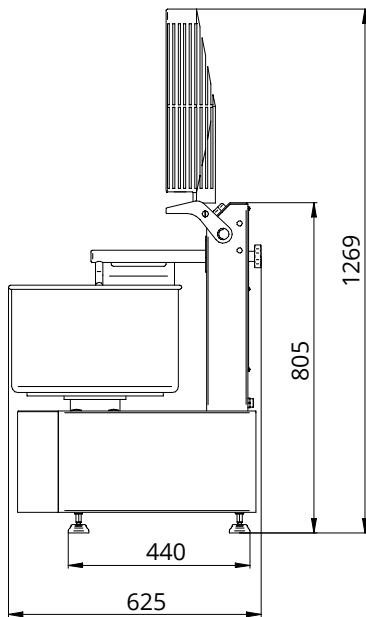

BERTA35

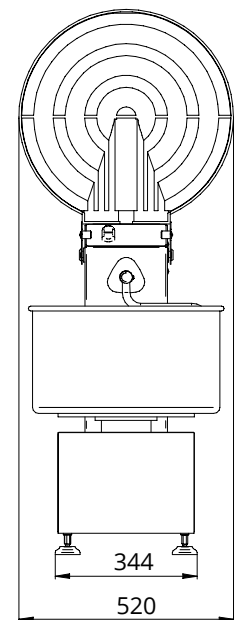
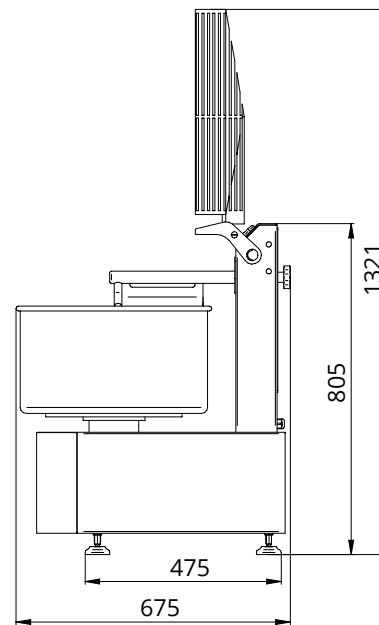

FF30N



FF30NV

Impastatrice a forcella

FORK KNEADER
PÉTRISSEUR À FOURCHE
GABELKNETER
AMASADORA DE HORQUILLA
ВИЛОЧНЫЙ ТЕСТОМЕС

IT Impastatrice con utensile a forcella che consente la lavorazione degli impasti più duri permettendo un'ottima ossigenazione ed evitando il riscaldamento dell'impasto. Carcassa in acciaio verniciato - vasca, forcella e coperchio in acciaio inox AISI 304 - timer meccanico. La protezione della vasca per metà grigliata permette l'aggiunta degli ingredienti anche in lavorazione. Accessori: seconda velocità, carrello 10(h) cm o 40(h) cm.



EN Kneader with fork tool that allows the processing of the hardest doughs allowing an excellent oxygenation and avoiding the heating of the dough. Painted steel casing - AISI 304 stainless steel bowl, fork and lid - mechanical timer. The protection of the half grilled bowl allows the addition of ingredients also during processing. Accessories: second speed, trolley 10(h) cm or 40(h) cm.

FR Pétrisseur à fourche qui permet la transformation des pâtes les plus dures permettant une excellente oxygénation et évitant le chauffage de la pâte. Corps en acier verni - cuve, fourche et couvercle en acier inox AISI 304 - minuterie mécanique. La protection de la cuve à moitié grillé, permet l'ajout d'ingrédients même pendant le mélange. Accessoires: régulateur de vitesse, chariot 10(h) cm ou 40(h) cm.

DE Teigknetmaschine mit Gabelwerkzeug. Die Drehung des Gabelwerkzeugs ermöglicht die Verarbeitung selbst härtester Teige, was zu einer hervorragenden Sauerstoffversorgung führt und die Erwärmung des Teigs verhindert. Gehäuse aus lackiertem Stahl - Schüssel, Gabel und Deckel aus Edelstahl AISI 304 - mechanischer Zeitregler. Der Schutz des Schüssels, halb gegrillt, erlaubt die Zugabe der Zutaten auch während der Verarbeitung. Zubehör: Geschwindigkeitsregler, Wagen 10(h) cm oder 40(h) cm.

ES Máquina ideal para pizzerías, pastelerías y panaderías. La rotación de la herramienta con horquilla permite la elaboración también de las masas más duras con una excelente oxigenación, evitando que se caliente. Carcasa de acero pintado - bol, horquilla y tapa de acero inoxidable - temporizador mecánico. La protección del bol - con una red en una mitad- permite añadir ingredientes también durante la elaboración. Accesorios: mando de regulación de la velocidad, carrito 10(h) cm o 40(h) cm.

RU Тестомес с вилочной мешалкой. Вращающаяся мешалка в форме вилки позволяет приготовить даже самое жесткое тесто, обеспечивая отличную оксигенацию и предотвращая нагрев теста. Корпус из окрашенной стали - дежа, вилка и крышка из нержавеющей стали AISI 304 - механический таймер. Защита дежи, наполовину закрытая решеткой, позволяет добавлять ингредиенты даже во время приготовления теста. Аксессуары: регулятор скорости, тележка высотой 10 см или 40 см.

FF30N	
	0,75 kW (1 HP) 0,75/1,1 kW (1/1,5 HP) - 2nd speed (optional)
	230-400V/3/50Hz
	230V/1N/50Hz
	Meccanico - Mechanical - Механический
	90 Kg/h
	30 Kg
	35 L (ø 530 x 220(h) mm)
	24 rpm 24 - 35 rpm - 2nd speed (optional)
	1000 x 650 x 665/840(h) mm
	
	140 Kg
	152 Kg
	1160 x 770 x 780(h) mm
	0,696 m³



Optional 2nd speed - 2-я скорость опционально (3 PH)

Special Voltages - Разное питающее напряжение

OPTIONAL



Optional

ACCESSORIES
ACCESSOIRES
ZUBEHÖR
ACCESORIOS
AKCECCYAPЫ



CAV40FORFF30N0



CARFORFF30N0

	CAV40FORFF30N0
	Carrello - Trolley - Chariot - Wagen - Carrito - Тележка
 mm	652,9 x 589 x 427(h) mm
 NET Kg	8,4 Kg
 GROSS Kg	9,2 Kg
 mm	800 x 550 x 250(h) mm
 m ³	0,110 m ³

	CARFORFF30N0
	Carrello - Trolley - Chariot - Wagen - Carrito - Тележка
 mm	475 x 589 x 191,5(h) mm
 NET Kg	6,6 Kg
 GROSS Kg	7,4 Kg
 mm	800 x 550 x 250(h) mm
 m ³	0,110 m ³

FF30N

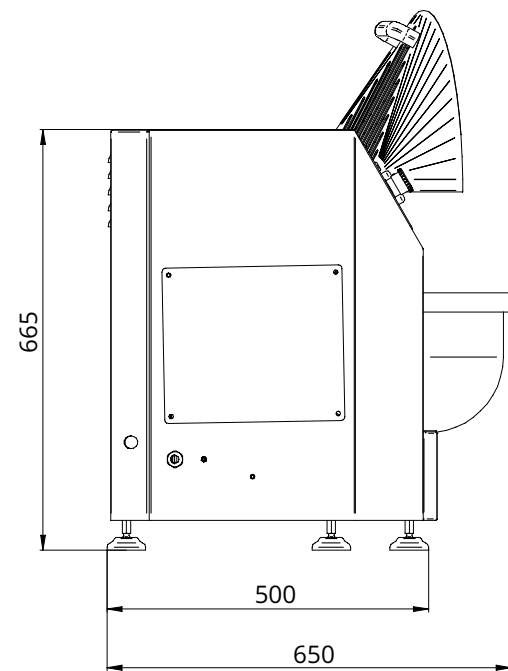
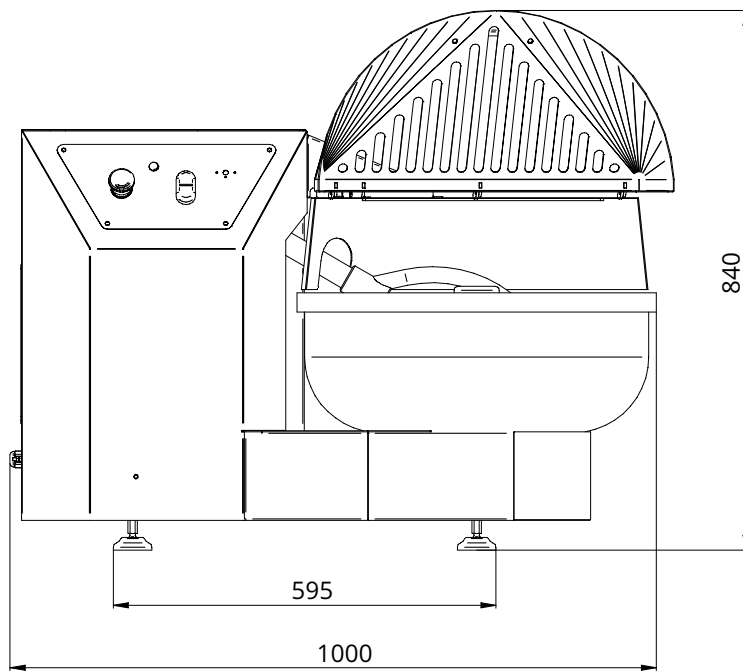

CAV40FORFF30N0

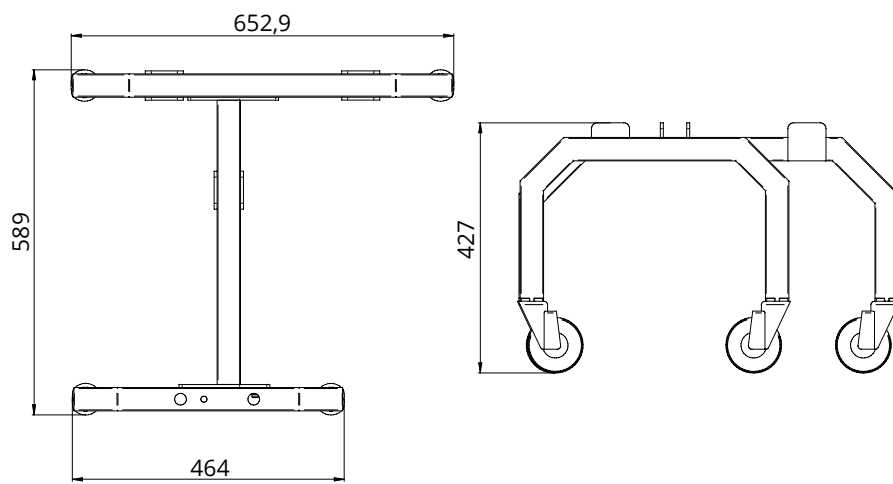

CARFORFF30N0

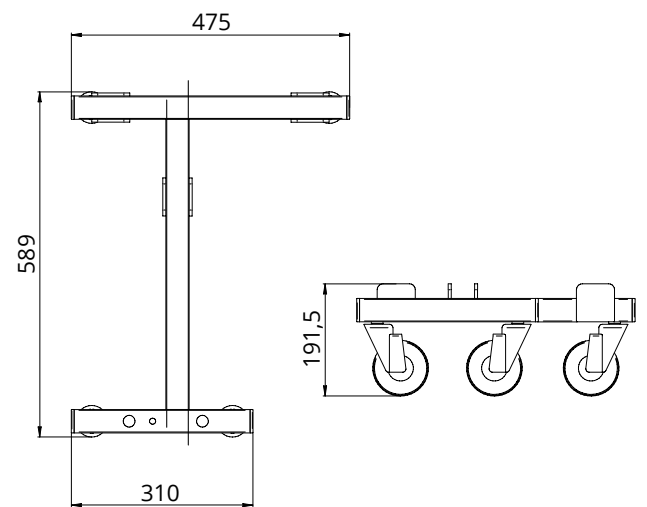

ARMINIT



ARMINIT

New

Arrotondatrice

DOUGH ROUNDER
ARRONDISSEUR DE PÂTE
BOLEADORA
TEIGABRUNDER
ТЕСТООКРУГЛИТЕЛИ

- IT** Macchina per arrotondare impasti pizza e realizzare palline da 30 a 300 gr con idratazione fino al 60% senza stressare e scaldare la pasta. Struttura in acciaio inox - coclea in alluminio teflonato - caduta palline ad altezza banco - 4 ruote ø 60 mm di cui 2 con freno.
- EN** Machine for rounding pizza dough and making balls from 30 to 300 g with hydration of up to 60% with no stress and heating of dough. Stainless steel structure - Teflon-coated aluminium screw - ball drop at counter height - 4 wheels ø 60 mm, 2 of which with brake.
- FR** Machine pour arrondir la pâte à pizza et réaliser des boules de 30 à 300 g avec une hydratation jusqu'à 60% sans stresser et chauffer la pâte. Corps en acier inox - Visseuse en aluminium téflonné - chute des boules à hauteur de comptoir - 4 roues ø 60 mm, dont 2 avec frein.
- DE** Maschine zum Abrunden von Pizzateig und zur Herstellung von Kugeln von 30 bis 300 g mit einem Feuchtigkeitsgehalt von bis zu 60 %, ohne den Teig zu belasten oder zu erhitzen. Gehäuse aus Edelstahl - Schnecke aus teflonbeschichtetem Aluminium - Kugeln fallen auf die Höhe der Arbeitsfläche - 4 Räder ø 60 mm, 2 mit Bremsen.
- ES** Máquina para redondear masa de pizza y hacer bolas de 30 a 300 g con hidratación de hasta el 60% sin estresar ni calentar la masa. Estructura de acero inoxidable - tornillo sinfin de aluminio teflonado - caída de las bolas a altura encimera - 4 ruedas ø 60 mm, 2 con freno.
- RU** Машина для округления теста для пиццы и изготовления шариков от 30 до 300 г с гидратацией до 60% без напряжения и нагрева теста. Конструкция из нержавеющей стали - алюминиевый шнек с тефлоновым покрытием - шарики опускаются до уровня столешницы - 4 колеса ø 60 мм, 2 с тормозами.



ARMINIT	
	0,37 kW (0,33 HP)
	230-400V/3N/50Hz
	230V/1N/50Hz
	1800 / 2400 h/N.
	280 x 420 x 790(h) mm
	
	40 Kg
	50 Kg
	390 x 620 x 1000(h) mm
	0,242 m³

Special Voltages - Разное питающее напряжение

FI32N
FI42N
FIP42N



FI32N



GUARDA IL VIDEO
WATCH THE VIDEO



FIP42N



FI42N



GUARDA IL VIDEO
WATCH THE VIDEO

Stendipizza a due coppie di rulli

PIZZA ROLLER MACHINE
FAÇONNEUSE POUR PIZZA
PIZZATEIGAUSSROLLMASCHINE
MÁQUINA PARA EXTENDER
MASA DE PIZZA CON RODILLOS
ТЕСТОРАСКАТОЧНАЯ МАШИНА ДЛЯ ПИЦЦЫ

IT Macchina per stendere impasti di pizza, pane, piada, focacce, ecc. Struttura interamente in acciaio inox AISI 304 - rulli in resina alimentare - leva di regolazione spessore su entrambe i gruppi - apertura rulli da 0,3 mm a max 5,5 mm - rulli superiori inclinati (FI32N-42N) o paralleli (FIP42N) per realizzare diverse forme. Il sistema con micro di sicurezza si trova sul coperchio protezione rulli superiori e permette il funzionamento solo a coperchio chiuso.











EN Machine to roll out doughs of pizza, bread, piadina, focaccia, etc.. Structure entirely in stainless steel AISI 304 - food safe resin rollers - lever for thickness adjustment on both groups - roller opening from 0.3 mm to max. 5.5 mm - upper rollers inclined (FI32N-42N) or parallel (FIP42N) to create different forms. The system with safety micro is located on the lid protection of upper rollers and allows operation only when the lid is closed.

FR Machine à rouler les pâtes de pizza, pain, piadina, focaccia, etc... Corps entièrement en acier inox AISI 304 - rouleaux en résine alimentaire - levier de réglage de l'épaisseur sur les deux unités - ouverture des rouleaux de 0,3 mm à 5,5 mm maximum - rouleaux supérieurs inclinés (FI32N-42N) ou rouleaux parallèles (FIP42N) pour créer différentes formes. Le système de sécurité avec microinterrupteur est situé sur le couvercle de protection des rouleaux supérieurs et ne permet le fonctionnement que lorsque le couvercle est fermé.

DE Maschine zum Ausrollen von Pizza-, Brot-, Piada-, Fladenteig usw. Gehäuse vollständig aus Edelstahl AISI 304 - Rollen aus Lebensmittelharz - Dickenverstellhebel an beiden Einheiten - Rollenöffnungsweite von 0,3 mm bis max. 5,5 mm - obere Rollen geneigt (FI32N-42N) oder parallel (FIP42N) zur Zubereitung verschiedener Formen. Das Mikrosicherheitssystem befindet sich auf dem oberen Rollenschutzdeckel und erlaubt den Betrieb nur bei geschlossenem Deckel.

ES Máquina para estirar masas de pizza, pan, tortilla, etc. Estructura completamente de acero inoxidable AISI 304 - rodillos de resina para alimentos - palanca de regulación espesor en ambos grupos - distancia entre rodillos de 0,3 mm a max 5,5 mm - rodillos superiores inclinados (FI32N-42N) o paralelos (FIP42N) para realizar diferentes formas. Sistema con microinterruptor de seguridad, ubicado en la tapa de protección de los rodillos superiores, que permite el funcionamiento sólo con la tapa cerrada.

RU Машина для раскатки теста для пиццы, хлеба, пьядины, лепешек и т. д. Корпус полностью из нержавеющей стали AISI 304 - валки из пищевой смолы - рычаг регулировки толщины на обоих узлах - ширина просвета от 0,3 мм до макс. 5,5 мм - верхние валки наклонные (FI32N-42N) или параллельные (FIP42N) для подготовки различных форм. Микросистема безопасности расположена на верхней защитной крышке валков и позволяет работать только при закрытой крышке.

	FI32N	FI42N	FIP42N
			
	0,37 kW (0,5 HP)		
	230V/1N/50Hz		
	320 mm	420 mm	
	Min. 0,3 - Max. 5,5 mm		
	460 x 510 x 630÷700(h) mm	590 x 540 x 760÷820(h) mm	590 x 515 x 700÷770(h) mm
			
	36 Kg	44 Kg	45 Kg
	45 Kg	53 Kg	54 Kg
	680 x 610 x 760(h) mm		
	0,357 m ³		

Special Voltages - Разное питающее напряжение

FI32N

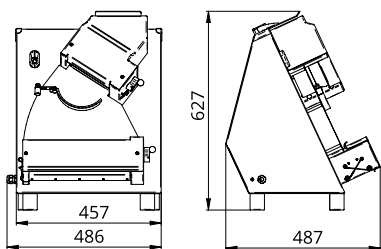

FI42N

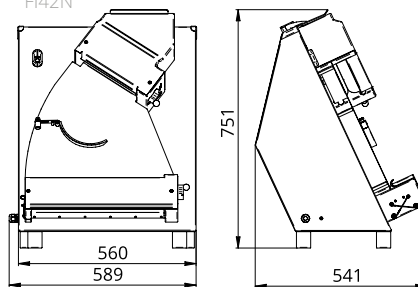

FIP42N

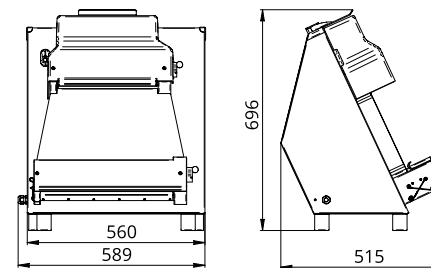

FIM42N



Stendipizza monorullo



GUARDA IL VIDEO
WATCH THE VIDEO

PIZZA ROLLER MACHINE
FAÇONNEUSE POUR PIZZA
PIZZATEIGAUSSROLLMASCHINE
MÁQUINA PARA EXTENDER MASA
DE PIZZA CON RODILLOS
ТЕСТОРАСКАТОЧНАЯ МАШИНА ДЛЯ ПИЦЦЫ

- IT** Macchina per stendere impasti di pizza, piada, focacce, ecc. Struttura interamente in acciaio inox AISI 304 - singola coppia di rulli in resina alimentare - leva di regolazione spessore. Il sistema con micro di sicurezza si trova sul coperchio protezione rulli superiori e permette il funzionamento solo a coperchio chiuso.
- EN** Machine to roll out doughs of pizza, bread, piadina, focaccia, etc. Structure entirely in stainless steel AISI 304 - food safe resin rollers - lever for thickness adjustment . The system with safety micro is located on the lid protection of upper rollers and allows operation only when the lid is closed.
- FR** Machine à rouler les pâtes de pizza, pain, piadina, focaccia, etc. Corps entièrement en acier inox AISI 304 - Paire de rouleaux en résine alimentaire - levier de réglage de l'épaisseur. Le système de sécurité avec microinterrupteur est situé sur le couvercle de protection des rouleaux supérieurs et ne permet le fonctionnement que lorsque le couvercle est fermé.
- DE** Maschine zum Ausrollen von Pizza, Brot, Piada, Fladenteig usw. Gehäuse vollständig aus Edelstahl AISI 304 - Rollen aus Lebensmittelharz - Dickenverstellhebel. Das Mikrosicherheitssystem befindet sich auf dem oberen Rollen-schutzdeckel und erlaubt den Betrieb nur bei geschlossenem Deckel.
- ES** Máquina para estirar masas de pizza, pan, tortilla, etc. Estructura completamente de acero inoxidable AISI 304 - única pareja de rodillos de resina para alimentos - palanca de regulación espesor. Sistema con microinterruptor de seguridad, ubicado en la tapa de protección de los rodillos superiores, que permite el funcionamiento sólo con la tapa cerrada.
- RU** Машина для раскатки теста для пиццы, хлеба, пьядины, лепешек и т. д. Корпус полностью из нержавеющей стали AISI 304 - валки из пищевой смолы - рычаг регулировки толщины. Микросистема безопасности расположена на верхней защитной крышке валков и позволяет работать только при закрытой крышке.

FIM42N	
	0,37 kW (0,5 HP)
	230V/1N/50Hz
	420 mm
	min 0,3 - max 5,5 mm
	560 x 410 x 450(h) mm
	
	30 Kg
	38 Kg
	750 x 500 x 450(h) mm
	0,168 m³

Special Voltages - Разное питающее напряжение

FIM42N

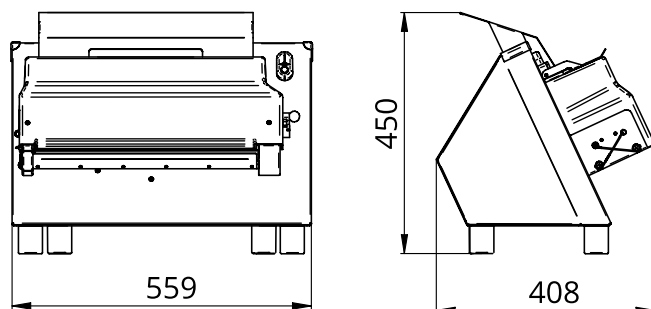

SI320
SI420
SI520



SI420



GUARDA IL VIDEO
WATCH THE VIDEO



SI420
OPTIONAL
TAGLIASFOGLIA
PASTRY CUTTER

Sfogliatrici stendipizza

PASTA AND PIZZA ROLLER MACHINE
FAÇONNEUSE POUR PÂTE ET PIZZA
PIZZA UND TEIGAUSSROLLMASCHINE
MÁQUINA PARA EXTENDER MASA
DE PIZZA CON RODILLOS
ТЕСТОРАСКАТОЧНАЯ МАШИНА ДЛЯ ПИЦЦЫ

IT Macchina per stendere impasti all'uovo, pizza e piada. Struttura interamente in acciaio inox AISI 304 - rulli in acciaio inox AISI 304 lucidati a specchio - apertura rulli 0÷10 mm - pomello di regolazione spessore ultimo passaggio - microinterruttore su coperchio di protezione rulli.

Optional: tagliasfoglia singoli - taglio utile 220 mm - diverse misure di taglio da 2-4-6-12 mm.

EN Egg, pizza and piadina dough rolling machine. Structure entirely in stainless steel AISI 304 - rollers in stainless steel AISI 304 mirror-polished - roller opening 0÷10 mm - adjustment knob for last passage thickness - microswitch on roller protection lid.

Optional: single sheet cutter - 220 mm useful cut - different cutting sizes 2-4-6-12 mm.

FR Machine pour étendre les pâtes aux oeufs, la pizza et piadina. Corps entièrement en acier inox AISI 304 - rouleaux en acier inox AISI 304 polis brillants - ouverture des rouleaux 0÷10 mm - poignée de réglage 'épaisseur du dernier passage - microinterrupteur sur le couvercle de protection des rouleaux.

Accessoires: coupe-feuilles individuelles - coupe utile 220 mm - différentes tailles de coupe de 2-4-6-12 mm.

DE Maschine zum Ausrollen von Eimischungen, Pizza- und Piadateig. Rollen aus Hochglanz-Edelstahl - Rollenöffnungsweite 0÷10 mm - Dicke-Einstellknopf für den letzten Durchgang - Mikroschalter am Schutzdeckel der Rullen.

Auf Wunsch: Einzelblattschneider - 220 mm Nutzschnitt - verschiedene Schnittgrößen: 2-4-6-12 mm.

ES Máquina para estirar masas de pizza, pan, tortilla o masas con huevo. Estructura completamente de acero inoxidable AISI 304 - rodillos de acero inoxidable pulido espejo - distancia rodillos 0÷10 mm - perilla de regulación espesor último paso. Microinterruptor ubicado en la tapa de protección de los rodillos. Accesorios: cortadora de hojaldre - sección útil 220 mm - diferentes medidas de corte: 2-4-6-12 mm.

RU Машина для раскатывания яичных смесей, теста для пиццы и пьядины. Валки из полированной нержавеющей стали - просвет 0 ÷10 мм. - ручка регулировки толщины для последнего прохода - микропереключатель на защитной крышке валков.

По запросу: нож для нарезки листов - ширина реза 220 мм - различные параметры резания: 2-4-6-12 мм.



	SI320	SI420	SI520
	0,37 kW (0,5 HP)		
	230-400V/3/50Hz		
	230V/1N/50Hz		
	320 mm	420 mm	520 mm
	580 x 480 x 400(h) mm	680 x 480 x 400(h) mm	780 x 480 x 400(h) mm
	52 Kg	61 Kg	70 Kg
	61 Kg	70 Kg	79 Kg
	770 x 520 x 580(h) mm		
	0,232 m³		

Special Voltages - Разное питающее напряжение

	TGP2	TGP4	TGP6	TGP12
	Tagliasfoglia - Pastry cutter - Roulette à pâte - Nudelschneidegerät Cortadora de masa - Прибор для нарезки тонких слоёв теста			
	2 mm	4 mm	6 mm	12 mm
	300 x 70 x 55(h) mm			
	3,2 Kg		3,5 Kg	
	400 x 180 x 180(h) mm		0,014 m³	

PLN40D
PLN60D
PLN80D



PLN60D

Impastatrice planetaria

variatore di velocità e comandi digitali

PLANETARY MIXER
MÉLANGEUR PLANÉTAIRE
PLANETENMISCHER
AMASADORA PLANETARIA
ПЛАНЕТАРНЫЙ ТЕСТОМЕС

IT Impastatrice planetaria con variatore di velocità e comandi digitali. Macchina per diversi tipi di impasto quali pizza, pane, biscotti, croissant, brioches, bigné, pan di spagna, pasta frolla, meringhe, puree, salse varie, panna montata, ecc. Struttura rivestita con vernice antigraffio - carter superiore in ABS - vasca, frusta e protezione vasca in acciaio inox AISI 304 - uncino e spatola in alluminio - microinterruttore su protezione vasca - vasca estraibile - innesto rapido utensili.













EN Planetary mixer with speed variator and digital controls. Machine for different types of dough such as pizza, bread, biscuits, croissants, brioches, cream puffs, sponge cake, shortcrust pastry, meringues, purees, various sauces, whipped cream, etc.. Frame coated with scratch-proof paint - upper casing in ABS - bowl, whip and bowl protector in stainless steel AISI 304 - hook and spatula in aluminium - microswitch on bowl protector - removable bowl - quick tool connection.

FR Mélangeur planétaire avec variateur de vitesse et commandes numériques. Machine pour différents types de pâte tels que pizza, pain, biscuits, croissants, brioches, pains à la crème, gâteau éponge, pâte Brisée, meringues, purées, sauces, crème fouettée, etc. Corps recouvert de peinture anti-rayures - carter supérieur en ABS - cuve, fouet et protection de la cuve en acier inox AISI 304 - crochet et spatule en aluminium - microinterrupteur sur la cuve la protection de la cuve - cuve amovible - dégagement rapide des outils.

DE Planetenmischer mit Drehzahlregler und digitaler Steuerung. Maschine für verschiedene Teigarten wie Pizza, Brot, Kekse, Croissants, Hörnchen, Beignets, Biskuitkuchen, Mürbeteig, Meringues, Pürees, verschiedene Soßen, Schlagsahne, usw... Gehäuse mit kratzfester Lackierung - Obergehäuse aus Kunststoff - Teigschüssel, Rührerinsatz und Wannenschutz aus Edelstahl AISI 304 - Haken und Spachtel aus Aluminium - Mikroschalter an Wannenschutz und Teigschüssel - ausziehbare Teigschüssel - Werkzeugschnellkupplung.

ES Amasadora planetaria con variador de velocidad y mandos digitales. Máquina para varios tipos de masas, como pizza, pan, galletas, croissants, brioches, petisúes, bizcocho, merengues, pureas, varias salsas, nata montada, etc. Estructura recubierta con pintura anti-arañazos, cárter superior de ABS - bol, batidor y protección del bol de acero inoxidable AISI 304 - gancho y espátula de aluminio - microinterrupción en la protección del bol - bol extraíble - enganche rápido de utensilios.

RU Планетарный тестомес с регулятором скорости и цифровым управлением. Машина для приготовления различных видов теста, например, для пиццы, хлеба, печенья, круассанов, бисквита, песочного теста, безе, пюре, различных соусов, взбитых сливок и т.д. Корпус покрыт устойчивой к царапинам краской - пластиковый верхний кожух - дежа для теста, мешалка и защита чаши из нержавеющей стали AISI 304 - крючок и лопатка из алюминия - микровыключатель на защите чаши и дежи для теста - извлекаемая дежа для теста - быстроразъемная муфта.

	PLN40D	PLN60D	PLN80D
	2,2 kW (3 HP)	3 kW (4 HP)	
	400V/3/50-60Hz		
	Digitale - Digital - Цифровой		
	40 L	60 L	80 L
	min. 30 - max. 120 rpm		
	915 x 655 x 1486(h) mm	930 x 725 x 1679(h) mm	
			
	250 Kg	280 Kg	290 Kg
	260 Kg	295 Kg	310 Kg
	1100 x 800 x 1800(h) mm		
	1,584 m³		

Special Voltages - Разное питающее напряжение

PLN12BV-PLN20BV
PLN20V-PLN40V
PLN60V-PLN80V



PLN40V

Impastatrice planetaria

variatore con inverter e comandi meccanici

PLANETARY MIXER
MÉLANGEUR PLANÉTAIRE
PLANETENMISCHER
AMASADORA PLANETARIA
ПЛАНЕТАРНЫЙ ТЕСТОМЕС

IT Impastatrice planetaria con variatore di velocità, comandi meccanici e inverter. Macchina per diversi tipi di impasto quali pizza, pane, biscotti, croissant, brioches, bigné, pan di spagna, pasta frolla, meringhe, puree, salse varie, panna montata, ecc. Struttura rivestita con vernice antigraffio, carter superiore in ABS - vasca e frusta in acciaio inox AISI 304 - uncino e spatola in alluminio - microinterruttore su protezione vasca - vasca estraibile - innesto rapido utensili - modelli da banco (PLN12BV-PLN20BV).

FR Mélangeur planétaire avec variateur de vitesse et commandes mécaniques. Machine pour différents types de pâte tels que pizza, pain, biscuits, croissants, brioches, pains à la crème, gâteau éponge, pâte brisée, meringues, purées, sauces, crème fouettée, etc. Corps recouvert de peinture anti-rayures - carter supérieur en ABS - cuve, fouet en acier inox AISI 304 - crochet et spatule en aluminium - microinterrupteur sur la cuve la protection de la cuve - cuve amovible - dégagement rapide des outils. Modèle à poser (PLN12BV-PLN20BV).

ES Amasadora planetaria con variador de velocidad y mandos mecánicos e invertidor. Máquina para varios tipos de masas, como pizza, pan, galletas, croissants, brioches, petisúes, bizcocho, merengues, pureas, varias salsas, nata montada, etc. Estructura recubierta con pintura anti-arañazos, cárter superior de ABS - bol y batidorde acero inoxidable AISI 304 - gancho y espátula de aluminio - microinterruptor en la protección del bol - bol extraíble - enganche rápido de utensilios. Modelos para bancos de trabajo (PLN12BV-PLN20BV).

EN Planetary mixer with speed variator and mechanical controls. Machine for different types of dough such as pizza, bread, biscuits, croissants, brioches, cream puffs, sponge cake, shortcrust pastry, meringues, purees, various sauces, whipped cream, etc.. Frame coated with scratch-proof paint - upper casing in ABS - bowl, whip in stainless steel AISI 304 - hook and spatula in aluminium - microswitch on bowl protector - removable bowl - quick tool connection. Counter model (PLN12BV-PLN20BV).

DE Planetenmischer mit Drehzahlregler, mechanischer Steuerung und Umrichter. Maschine für verschiedene Teigarten wie Pizza, Brot, Kekse, Croissants, Hörnchen, Beignets, Biskuitkuchen, Mürbeteig, Meringues, Pürees, verschiedene Soßen, Schlagsahne, usw... Gehäuse mit kratzfester Lackierung - Obergehäuse aus Kunststoff - Teigschüssel, Rührersatz aus Edelstahl AISI 304 - Haken und Spachtel aus Aluminium - Mikroschalter an Wannenschutz und Teigschüssel - ausziehbare Teigschüssel - Werkzeugschnellkupplung. Tischmodell (PLN12BV-PLN20BV).













RU Планетарный тестомес с регулятором скорости, механическим управлением и инвертором. Машина для приготовления различных видов теста, например, для пиццы, хлеба, печенья, круассанов, бисквита, песочного теста, безе, пюре, различных соусов, взбитых сливок и т.д. Корпус покрыт устойчивой к царапинам краской - дежа для теста и мешалка из нержавеющей стали AISI 304 - крючок и лопатка из алюминия - микровыключатель на защите чаши и дежи для теста - извлекаемая дежа для теста - быстроразъемная муфта. Настольная модель (PLN12BV-PLN20BV).



GUARDA IL VIDEO
WATCH THE VIDEO



PLN12BV
MODELLO DA BANCO
COUNTER MODEL

	PLN12BV	PLN20BV	PLN20V	PLN40V	PLN60V	PLN80V
	0,5 kW (0,7 HP)		0,75 kW (1 HP)	2,2 kW (3 HP)	3 kW (4 HP)	
	-		400V/3/50-60Hz			
	230V/1N/50-60Hz			-		
	Meccanico - Mechanical - Механический 0÷30'					
	10 L	20 L		40 L	60 L	80 L
	min. 30 - max. 120 rpm					
	541 x 381 x 648(h) mm	604 x 440 x 716(h) mm	735 x 467 x 1274(h) mm	915 x 655 x 1486(h) mm	930 x 725 x 1679(h) mm	
						
	47 Kg	56 Kg	110 Kg	250 Kg	280 Kg	290 Kg
	55 Kg	64 Kg	136 Kg	260 Kg	295 Kg	310 Kg
	750 x 490 x 900(h) mm		890 x 680 x 1400(h) mm	1100 x 800 x 1800(h) mm		
	0,331 m³		0,847 m³	1,584 m³		

Special Voltages - Разное питающее напряжение

Impastatrice planetaria

3 velocità con comandi meccanici

PLANETARY MIXER
MÉLANGEUR PLANÉTAIRE
PLANETENMISCHER
AMASADORA PLANETARIA
ПЛАНЕТАРНЫЙ ТЕСТОМЕС

PLN20M
PLN40M
PLN60M



PLN40M

IT Impastatrice planetaria con variatore a 3 velocità e comandi meccanici. Macchina per diversi tipi di impasto quali pizza, pane, biscotti, croissant, brioches, bignè, pan di spagna, pasta frolla, meringhe, puree, salse varie, panna montata, ecc. Struttura rivestita con vernice antigraffio, carter superiore in ABS - vasca, frusta e protezione vasca in acciaio inox AISI 304 - uncino e spatola in alluminio - microinterruttore su protezione vasca - vasca estraibile - innesto rapido utensili.











EN Planetary mixer with 3 speeds variator and mechanical controls. Machine for different types of dough such as pizza, bread, biscuits, croissants, brioches, cream puffs, sponge cake, shortcrust pastry, meringues, purees, various sauces, whipped cream, etc...Frame coated with scratch-proof paint - upper casing in ABS - bowl, whip and bowl protector in stainless steel AISI 304 - hook and spatula in aluminium - microswitch on bowl protector - removable bowl - quick tool connection.

FR Mélangeur planétaire avec variateur à 3 vitesses et commandes mécaniques. Machine pour différents types de pâte tels que pizza, pain, biscuits, croissants, brioches, pains à la crème, gâteau éponge, pâte Brisée, meringues, purées, sauces, crème fouettée, etc. Corps recouvert de peinture anti-rayures - carter supérieur en ABS - cuve, fouet et protection de la cuve en acier inox AISI 304 - crochet et spatule en aluminium - microinterrupteur sur la cuve la protection de la cuve - cuve amovible - dégagement rapide des outils.

DE Planetenmischer mit 3-Gänge-Drehzahlregler und mechanischer Steuerung. Maschine für verschiedene Teigarten wie Pizza, Brot, Kekse, Croissants, Hörnchen, Beignets, Biskuitkuchen, Mürbeteig, Meringues, Pürees, verschiedene Soßen, Schlagsahne, usw...Gehäuse mit kratzfester Lackierung - Obergehäuse aus Kunststoff - Teigschüssel, Rührersatz und Wannenschutz aus Edelstahl AISI 304 - Haken und Spachtel aus Aluminium - Mikroschalter an Wannenschutz und Teigschüssel - ausziehbare Teigschüssel - Werkzeugschnellkupplung.

ES Amasadora planetaria con variador de 3 velocidades y mandos mecánicos. Máquina para varios tipos de masas, como pizza, pan, galletas, croissants, brioches, petisúes, bizcocho, merengues, pureas, varias salsas, nata montada, etc. Estructura recubierta con pintura anti-arañazos, cárter superior de ABS - bol, batidor y protección del bol de acero inoxidable AISI 304 - gancho y espátula de aluminio - microinterruptor en la protección del bol - bol extraíble - enganche rápido de utensilios.

RU Планетарный тестомес с 3-х скоростным регулятором скорости и механическим управлением. Машина для приготовления различных видов теста, например, для пиццы, хлеба, печенья, круассанов, бисквита, песочного теста, безе, пюре, различных соусов, взбитых сливок и т.д. Корпус покрыт устойчивой к царапинам краской - пластиковый верхний кожух - дежа для теста, мешалка и защита чаши из нержавеющей стали AISI 304 - крючок и лопатка из алюминия - микровыключатель на защите чаши и дежи для теста - извлекаемая дежа для теста - быстроразъемная муфта.

	PLN20M	PLN40M	PLN60M
			
	0,5/0,75/1,1 kW (0,7/1/1,5 HP)	0,75/1/1,3 kW (1/1,5/1,75 HP)	1,1/1,5/1,7 kW (1,5/2/2,2 HP)
	400V/3/50Hz		
	Meccanico - Mechanical - Механический 0+30'		
	20 L	40 L	60 L
	30 - 60 - 120 rpm		
	735 x 467 x 1274(h) mm	915 x 655 x 1486(h) mm	930 x 725 x 1679(h) mm
			
	110 Kg	250 Kg	280 Kg
	136 Kg	260 Kg	295 Kg
	890 x 680 x 1400(h) mm	1100 x 800 x 1800(h) mm	
	0,847 m³	1,584 m³	

Special Voltages - Разное питающее напряжение

Optional

ACCESSORIES
ACCESSOIRES
ZUBEHÖR
ACCESORIOS
AKCECCYAPЫ



ACPLN12BL



ACPLN12HK



ACPLN12VP



ACPLN12BR



ACPLN40CAR

Mod.	Kit riduzione (vasca + frusta + uncino + spatola) Reduction kit (bowl+whisk + hook + spatula) Kit réduction (cuve + fouet + crochet + spatule) Verringerungssatz (Teigschüssel + Rührersatz + Haken + Spachtel) Kit reducción (bol + batidor + gancho + espátula) Редукционный набор (дежа для теста + мешалка + крюк + лопатка)
80/60 L	ACPLNRID8060
80/40 L	ACPLNRID8040
60/40 L	ACPLNRID6040
60/20 L	ACPLNRID6020
40/20 L	ACPLNRID4020

Mod.	Carrello vasca Bowl trolley Chariot cuve Wagen für Teigschüsselwagen carro del Bol Тележка для дежи
PLN40 M-D-V	ACPLN40CAR
PLN60 M-D-V	ACPLN60CAR
PLN80 M-D-V	ACPLN80CAR

Mod.	Vasca - Bowl - Cuve Teigschüssel - Bol - Ёмкость	Uncino - Hook - Crochet Haken - Gancho - Крюк	Frusta - Whisk - Fouet Rührersatz - Batidor - Венчик	Spatola - Spatula - Spatule Schaber - Espátula - Лопатка
PLN12BV	ACPLN12BL	ACPLN12HK	ACPLN12WP	ACPLN12BR
PLN20BV	ACPLN20BVBL	ACPLN20BVHK	ACPLN20BVWP	ACPLN20BVBR
PLN20 M-V	ACPLN20MBL	ACPLN20HK	ACPLN20WP	ACPLN20BR
PLN40 M-V-D	ACPLN40BL	ACPLN40HK	ACPLN40WP	ACPLN40BR
PLN60 M-V-D	ACPLN60BL	ACPLN60HK	ACPLN60WP	ACPLN60BR
PLN80 V-D	ACPLN80BL	ACPLN80HK	ACPLN80WP	ACPLN80BR

PLN 12BV

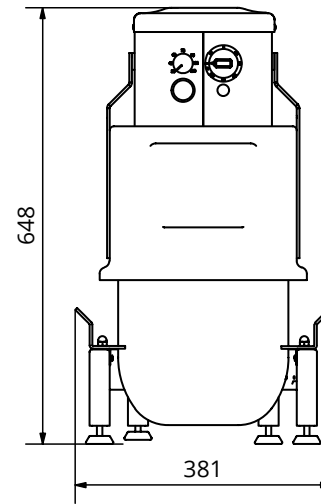
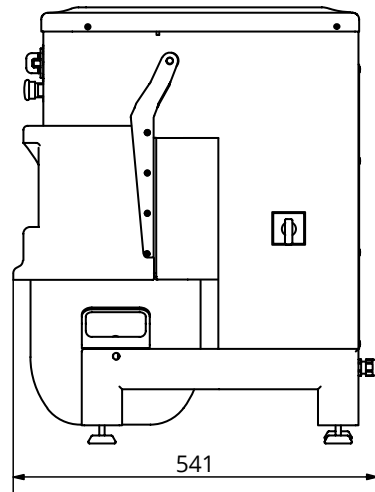

PLN 20BV

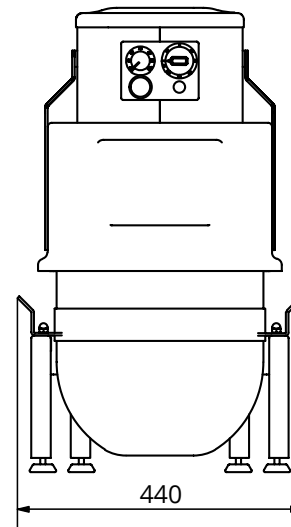
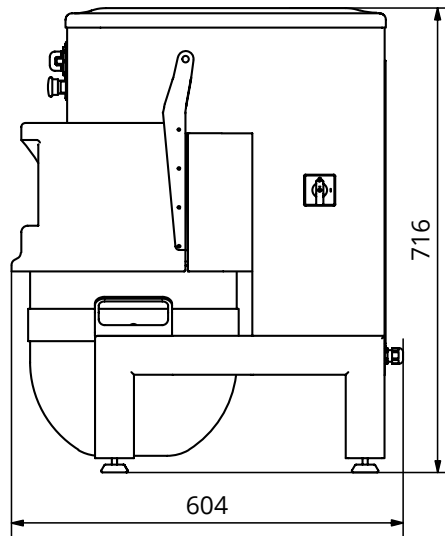

PLN 20

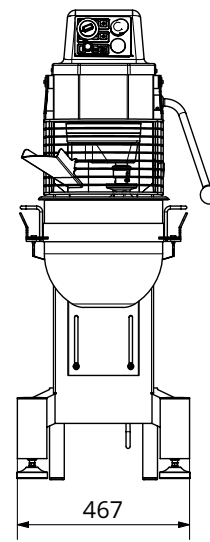
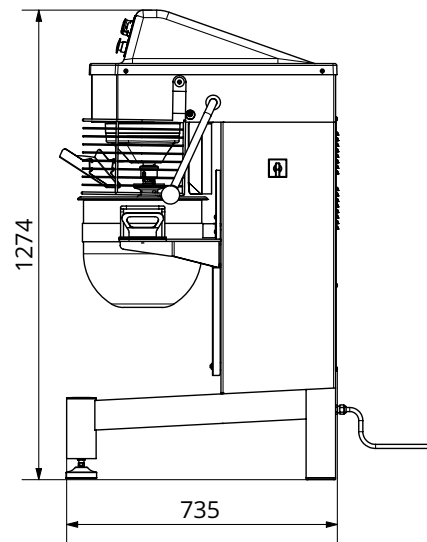

PLN 40

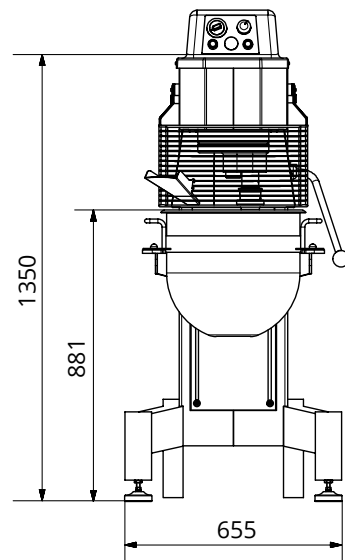
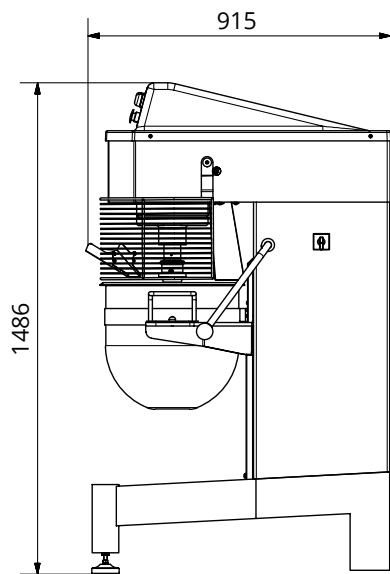

PLN 60-80

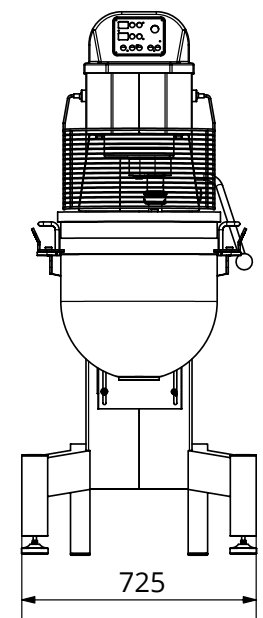
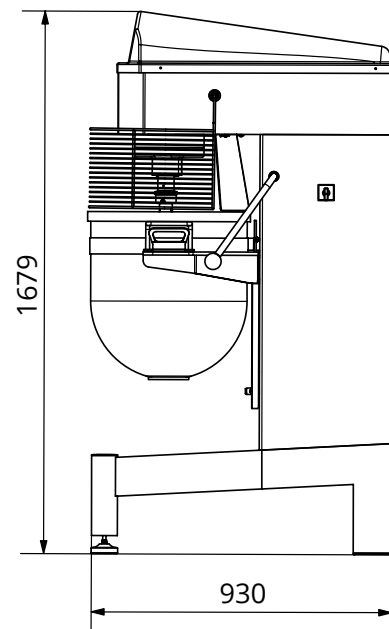



Taglio, pelatura e conservazione

CUTTING PEELING
AND CONSERVATION
COUPE, PELAGE ET CONSERVATION
SCHNEIDEN, SCHÄLEN UND LAGERN
CORTAR, PELAR Y CONSERVAR
РЕЗКА, ОТСЛАИВАНИЕ И ХРАНЕНИЕ

IT

Per velocizzare e rendere più semplice il lavoro nella ristorazione professionale sono fondamentali alcuni macchinari come: Tagliaverdure, Tagliamozzarella, Cutter, Pelapatate, Lavacozze, Lavaverdure, Affettatrici e Asciuga Lucida Posate.

Il brand Fimar si è specializzato anche nella conservazione offrendo la possibilità di scelta tra: Macchine Sottovuoto a Campana, a Barra Saldante o Termosigillatrici.

EN

A few appliances are essential to facilitate and accelerate work in professional catering: Vegetable Cutters, Mozzarella Cutters, Cutters, Potato Peelers, Mussel Washers, Vegetable Washers, Slicers and Polished Cutlery Dryers.

The Fimar brand has also focused on conservation, offering the possibility of choosing between: Vacuum machines, sealing bars or heat sealers.

FR

Pour accélérer et faciliter le travail dans la restauration professionnelle, quelques machines sont indispensables, telles que: Coupe-légumes, coupe-mozzarella, cutter, éplucheuses de pommes de terre, lave-moules, lave-légumes, trancheuses et machines à essuyer et polir la vaisselle.

La marque Fimar s'est également spécialisée dans la conservation, en offrant la possibilité de choisir entre: Machines sous-vide, machines à barres de soudure ou thermoscelleuses.

DE

Um die Arbeit in der professionellen Gastronomie zu beschleunigen und zu erleichtern, sind einige Maschinen unerlässlich, wie zum Beispiel: Gemüseschneider, Mozzarella-Schneider, Schneidegeräte, Kartoffelschäler, Muschelwaschmaschinen, Gemüseschneider, Aufschnittmaschinen und Besteckrockner/-polierer.

Die Firma Fimar hat sich auch auf die Aufbewahrung konzentriert und bietet eine Auswahl an: Vakuumverpacker mit Kammer oder mit Schweißleiste, oder Heißsiegelgeräte.

ES

Para acelerar y facilitar el trabajo en la hostelería tradicional se necesitan unas máquinas como: cortador de verduras, cortador de mozzarella, cutter, pelapapas, limpiador de mejillones, limpiador de verduras, cortadoras, secadora y pulidora de vajillas.

La marca Fimar se especializó también en la conservación y propone estas soluciones: envasadora al vacío profesional envasadora con barra y selladoras térmicas.

RU

Для ускорения и облегчения работы в профессиональном кейтеринге необходимо несколько машин, например: Овощерезы, моцарелла, ножницы, ножницы, очистители картофеля, мидии, овощные шайбы, ломтики и сушилки для столовых приборов.

Бренд Fimar также специализируется на консервации, предлагая возможность выбора: Вакуумно-камерные машины, пломбировочные машины или термозаклеиватели.

MX20
MX20V2
MX20VV

Mini Mixer
IMMERSION BLENDER



GUARDA IL VIDEO
WATCH THE VIDEO



Mini Mixer
ad immersione

MINI MIXER
MINI MÉLANGEUR
MINI-MIXSTAB
MINI MEZCLADOR
МИНИ СМЕСИТЕЛЬ

IT Mescolatore realizzato in acciaio inox AISI 304, adatto a realizzare minestrone, puree di verdure, salse, pastelle, maionese, passato di pomodoro, pesto ecc. Il modello **MX20** a singola velocità è dotato del solo coltello multiuso; il modello **MX20V2** a 2 velocità è dotato di coltello multiuso ed accessori intercambiabili (affinatore ed emulsionatore); il modello **MX20VV** a velocità variabile è dotato di coltello multiuso ed accessori intercambiabili (affinatore ed emulsionatore).











EN Blending stick made of stainless steel AISI 304, ideal for making soups, vegetable purees, sauces, batters, mayonnaise, tomato puree, pesto, etc. The **MX20** single speed model is equipped with a multi-purpose knife only; the **MX20V2** 2 speed model is equipped with a multi-purpose knife and interchangeable accessories (crumbler and emulsifier); the **MX20VV** variable speed model is equipped with a multi-purpose knife and interchangeable accessories (crumbler and emulsifier).

FR Mélangeur en acier inoxydable AISI 304, idéal pour la préparation de soupes, purées de légumes, sauces, pâtes, mayonnaise, purée de tomates, pesto, etc. Le modèle **MX20** à une vitesse est équipé uniquement d'un couteau polyvalent; le modèle **MX20V2** à 2 vitesses est équipé d'un couteau polyvalent et d'accessoires interchangeables (broyeur et émulsifieur); le modèle **MX20VV** à vitesse variable est équipé d'un couteau polyvalent et d'accessoires interchangeables (broyeur et émulsifieur).

DE Mixstab aus Edelstahl AISI 304, ideal für die Zubereitung von Suppen, Gemüsepurees, Soßen, Teigwaren, Mayonnaise, Tomatenmark, Pesto, etc. Das Modell **MX20** mit einfacher Geschwindigkeit ist nur mit einem Mehrzweckmesser ausgestattet; das Modell **MX20V2** mit 2 Geschwindigkeiten ist mit einem Mehrzweckmesser und austauschbarem Zubehör (Krümler und Emulgator) ausgestattet; das Modell **MX20VV** mit variabler Geschwindigkeit ist mit einem Mehrzweckmesser und austauschbarem Zubehör (Krümler und Emulgator) ausgestattet.

ES Mezclador de acero inoxidable AISI 304, ideal para sopas, purés de verduras, salsas, masas, mayonesas, salsa de tomate, pesto, etc. El modelo **MX20** de una velocidad está equipado únicamente con una cuchilla polivalente; el modelo **MX20V2** de 2 velocidades está equipado con una cuchilla polivalente y accesorios intercambiables (refinador y emulsionador); el modelo **MX20VV** de velocidad variable está equipado con una cuchilla polivalente y accesorios intercambiables (refinador y emulsionador).

RU Смеситель изготовлен из нержавеющей стали AISI 304, пригоден для приготовления супов, овощных пюре, соусов, блюд, майонеза, томатного пюре, песто и др. Односкоростная модель **MX20** оснащена только универсальным ножом; двухскоростная модель **MX20V2** оснащена универсальным ножом и сменными насадками (гомогенизатор и эмульгатор); модель **MX20VV** с переменной скоростью оснащена универсальным ножом и сменными насадками (гомогенизатор и эмульгатор).

	MX20	MX20V2	MX20VV
			
	0,2 kW (0,5 HP)		
	230V/1N/50-60Hz		
	13.000 rpm 0,2 Kg - 250(h) mm	6.000/13.000 rpm 2nd speed 0,2 Kg - 250(h) mm	6.000÷13.000 rpm 0,2 Kg - 250(h) mm
	15 L		
	107 x 72 x 499(h) mm (con mescolatore / with mixer)		
			
	1,16 Kg		
	2 Kg		
	370 x 270 x 120(h) mm		
	0.011 m³		



Special Voltages - Разное питающее напряжение

MX25















GUARDA IL VIDEO
WATCH THE VIDEO



Mixer ad immersione

IMMERSION BLENDER
MÉLANGEUR À IMMERSION
EINTAUCH-MIXSTAB
TRITURADORA A INMERSIÓN
ПОГРУЖНОЙ БЛЕНДЕР

- IT** Macchina per ottenere diversi prodotti in base all'utensile utilizzato. Mescolatore realizzato interamente in acciaio inox AISI 304, utile per realizzare minestrone, puree di verdure, salse, pastelle, maionese, passato di pomodoro, pesto ecc... Il modello MX25 è dotato del solo mescolatore da 30 cm per un livello max di immersione fino a 19 cm. Possibilità di acquisto del solo blocco motore.
- EN** Machine for obtaining different mixtures according to the tool used. Blending stick made entirely of stainless steel AISI 304, ideal for making soups, vegetable purees, sauces, batters, mayonnaise, tomato puree, pesto, etc... The MX25 model is equipped with only a 30 cm blending stick for a maximum immersion level of up to 19 cm. You can purchase only the motor unit.
- FR** Machine pour obtenir différents mélanges en fonction de l'outil utilisé. Mélangeur entièrement en acier inoxydable AISI 304, idéal pour la préparation de soupes, purées de légumes, sauces, batters, mayonnaise, purée de tomates, pesto, etc... Le modèle MX25 est équipé seulement d'un mélangeur de 30 cm pour un niveau d'immersion maximum jusqu'à 19 cm. Il est possible d'acheter uniquement le groupe moteur.
- DE** Maschine zur Zubereitung verschiedener Mischungen je nach verwendetem Werkzeug. Mixstab komplett aus Edelstahl AISI 304, ideal für die Zubereitung von Suppen, Gemüsepürees, Saucen, Teigwaren, Mayonnaise, Tomatenmark, Pesto, etc... Das Modell MX25 ist mit nur einem 30 cm Mixstab für eine maximale Eintauchtiefe von bis zu 19 cm ausgestattet. Auf Wunsch können Sie nur die Motoreinheit kaufen.
- ES** Máquina para obtener diferentes productos según el tipo de herramienta que se utiliza. Mezclador de acero inoxidable AISI 304, ideal para sopas, purés de verduras, salsas, masas, mayonesas, salsa de tomate, pesto, etc... El modelo MX25 solo tiene un mezclador de 30 cm para una inmersión máxima de 19 cm. Se puede comprar sólo el bloque del motor.
- RU** Машина для получения различных смесей в зависимости от используемого инструмента. Смеситель, полностью изготовленный из нержавеющей стали AISI 304, идеально подходит для приготовления супов, овощных пюре, соусов, блюд, майонеза, томатного пюре, песто и т.д... Модель MX25 оснащена смесителем толщиной всего 30 см для максимального погружения до 19 см. Вы можете приобрести только моторный блок.

	MX25	
	0,25 kW (0,3 HP)	
	230V/1N/50-60Hz	
	 13000 rpm	 0,6 Kg - 300 mm
	30 L	
	135 x 100 x 600(h) mm	
		
	2,2 Kg	
	3,4 Kg	
	410 x 280 x 170(h) mm	
	0,020 m ³	

Special Voltages - Разное питающее напряжение

	MXM25	Blocco motore Motor unit моторный блок
---	-------	--

MX40-FX40



MX40



400 mm
Liv. Max. 290 mm



350 mm
Liv. Max. 200 mm

Mixer ad immersione

IMMERSION BLENDER
MÉLANGEUR À IMMERSION
EINTAUCH-MIXSTAB
TRITURADORA A INMERSIÓN
ПОГРУЖНОЙ БЛЕНДЕР

IT Macchina completa di mescolatore più frusta con variatore di velocità per ottenere diversi prodotti in base all'utensile utilizzato. Mescolatore realizzato interamente in acciaio inox AISI 304, utile per realizzare minestrone, puree di verdure, salse, pastelle, maionese, passato di pomodoro, pesto ecc. Frusta realizzata in acciaio inox AISI 304, utile per ottenere panna montata, creme, omelette, soufflé, ecc. Mescolatore di serie da 40 cm di lunghezza per un livello max di immersione fino a 29 cm e di una frusta di 35 cm con un livello max di immersione fino a 20 cm ed un blocco motore con variatore di velocità.

FR Machine équipée d'un mélangeur et d'un fouet avec régulateur de vitesse pour obtenir différents mélanges en fonction de l'outil utilisé. Mélangeur entièrement en acier inoxydable AISI 304, idéal pour la préparation de soupes, purées de légumes, sauces, pâtes, mayonnaise, purée de tomates, pesto, etc. Fouet entièrement en acier inoxydable AISI 304, idéal pour la préparation de crème fouettée, crèmes, omelettes, soufflés, etc. Mélangeur standard de 40 cm de longueur pour une immersion maximale de 29 cm et d'un fouet de 35 cm avec une immersion maximale de 20 cm et d'un groupe moteur avec régulateur de vitesse.

ES Máquina completa de mezclador y batidor con variador de la velocidad para obtener diferentes productos según el tipo de herramienta que se utiliza. Mezclador de acero inoxidable AISI 304, ideal para sopas, purés de verduras, salsas, masas, mayonesas, salsa de tomate, pesto, etc. Batidor de acero inoxidable AISI 304, ideal para cremas, nata, tortillas, soufflé, etc. Mezclador largo 40 cm para una inmersión máxima de 29 cm, y un batidor de 35 cm con una inmersión hasta 20 cm. También tiene el bloque del motor con variador de velocidad.

EN Machine fitted with mixer and whisk with speed regulator for obtaining different mixtures according to the tool used. Blending stick made entirely of stainless steel AISI 304, ideal for making soups, vegetable purees, sauces, batters, mayonnaise, tomato puree, pesto, etc. Whisk made entirely of stainless steel AISI 304, ideal for making whipped cream, creams, omelets, soufflés, etc. Standard blending stick 40 cm long for a maximum immersion level of up to 29 cm and a whisk of 35 cm with a level of max. immersion up to 20 cm and a motor unit with speed regulator.

DE Maschine mit Mixstab und Schneebesen mit Drehzahlregler zur Zubereitung verschiedener Mischungen je nach verwendetem Werkzeug. Mixstab komplett aus Edelstahl AISI 304, ideal für die Zubereitung von Suppen, Gemüsepürees, Soßen, Teigwaren, Mayonnaise, Tomatenmark, Pesto, etc. Schneebesen komplett aus Edelstahl AISI 304, ideal für die Zubereitung von Schlagsahne, Kremen, Omeletts, Soufflés, etc. Standard-Mixstab 40 cm Lang für einen maximalen Eintauchtiefe von bis zu 29 cm und einem Schneebesen von 35 cm mit einem maximalen Eintauchtiefe von bis zu 20 cm und einer Motoreinheit mit Drehzahlregler.

RU Машина в комплекте со смесителем и хлыстом с вариатором скорости для получения различных продуктов в зависимости от используемого инструмента. Смеситель полностью изготовлен из нержавеющей стали AISI 304, пригоден для приготовления супов, овощных пюре, соусов, блюд, майонеза, томатного пюре, песто и др. Кнут из нержавеющей стали AISI 304, полезен для получения взбитых сливок, сливок, омлетов, суфле и др. смесителем длиной 40 см для максимального уровня погружения до 29 см и хлыстом длиной 35 см с максимальным уровнем погружения до 20 см и моторным блоком с вариатором скорости.



GUARDA IL VIDEO
WATCH THE VIDEO



















FX40

OPTIONAL



185

183

	MX40	FX40
	0,4 kW (0,5 HP)	
	230V/1N/50-60Hz	
	 2500÷11000 rpm	 1,4 Kg - 400 mm
	 250÷1500 rpm	 1 Kg - 350 mm
	60 L	
	155 x 120 x 710/790(h) mm (con frusta/mescolatore - with whisk/mixer)	170 x 120 x 660/740(h) mm (con frusta/mescolatore - with whisk/mixer)
		
	4,5 Kg	
	6 Kg	
	490 x 390 x 170(h) mm	
	0,032 m³	

	MXM40	FXM40	Blocco motore con variatore - Motor unit with speed regulator моторным блоком с вариатором скорости
	MXM40S	FXM40S	Blocco motore senza variatore - Motor unit without speed regulator моторным блоком без вариатором скорости
	MX42	FX42	Blocco motore con variatore e mescolatore - Motor unit with speed regulator and stick blender моторным блоком с вариатором скорости и Смеситель
	MX42S	FX42S	Blocco motore senza variatore con mescolatore - Motor unit without speed regulator / with stick blender моторным блоком без вариатором скорости с Смеситель
	MX42F	FX42F	Blocco motore con variatore e frusta - Motor unit with speed regulator and whisk моторным блоком с вариатором скорост и Венчик
Special Voltages - Разное питающее напряжение			



Optional

ACCESSORIES
ACCESSOIRES
ZUBEHÖR
ACCESORIOS
AKCECCYAPЫ



EXPOMIXN

Espositore - Display stand
Présentoir - Ausstellungsständer
Expositor - Подставка

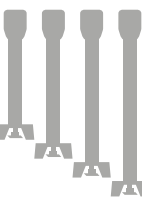
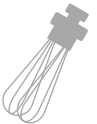
	Mod.		MX20	MX20V2 MX20VV	MX25	MX40 FX40	← mm →	Kg	
	ME2020	Mescolatore Blending stick Mélangeur Mixstab Braço mezclador Смесительный стержень	✓	✓	-	-	200 mm	0,2 Kg	max. 165 mm
	ME2530		-	-	✓	-	300 mm	1,2 Kg	max. 190 mm
	ME4030		-	-	-	✓	300 mm	1,2 Kg	max. 190 mm
	ME4040		-	-	-	✓	400 mm	1,4 Kg	max. 290 mm
	ME4050		-	-	-	✓	500 mm	1,6 Kg	max. 390 mm
	ME4060		-	-	-	✓	600 mm	1,8 Kg	max. 490 mm
	FRUSTAFM3	Frusta Whisk Fouet Schneebeesen Batidor Венчик	-	-	-	✓	350 mm	1 Kg	max. 200 mm

TV4000 L'ORTOLANA



TV4000



Tagliaverdura

VEGETABLE CUTTER
COUPE-LÉGUMES
GEMÜSESCHNEIDER
CORTADORAS DE HORTALIZAS
ОВОЩЕРЕЗКА

186



GUARDA IL VIDEO
WATCH THE VIDEO

 **fimar**

IT Macchina per tagliare, affettare e grattugiare.
TV4000 chiamato "L'ortolana": carcassa, bocca e contenitore di raccolta in acciaio inox AISI 304 - microinterruttori di sicurezza su maniglia, bocca e contenitore - doppia bocca inserimento prodotto - bocca ovale ~ 150x70 mm - bocca tonda ø 56 mm. Il prodotto lavorato cade direttamente nel contenitore di raccolta senza utilizzare il disco espulsore lasciandone inalterata l'integrità. Possibilità di avere un motore potenziato utile per la lavorazione di formaggi con consistenza compatta.













EN Cutting, slicing and gratin machine.
TV4000 "L'ortolana": casing, inlet and collection container made of stainless steel AISI 304 - safety microswitches on handle, inlet and container - double inlet for product insertion - oval inlet ~ 150x70 mm - round inlet ø 56 mm. The processed product falls directly into the collection container with no need to use the ejector disc, preserving the integrity of the product. Powered motor useful for processing cheeses with a compact consistency also available.

FR Machine à découper, trancher et à râper.
TV4000 "L'ortolana": corps, orifice d'entrée et cuve de collecte en acier Inox AISI 304 - micro-interrupteurs de sécurité sur la poignée, l'orifice d'entrée et la cuve - double entrée pour insertion produit - ouverture ovale ~ 150x70 mm - ouverture ronde ø 56 mm. Le produit traité tombe directement dans le récipient de collecte sans qu'il soit nécessaire d'utiliser le disque d'éjection, préservant ainsi l'intégrité du produit. Possibilité d'avoir un moteur plus performant, utile pour le traitement des fromages à consistance compacte.

DE Maschine zum Schneiden und Reiben.
TV4000 "L'ortolana": Gehäuse, Einführöffnung und Auffangbehälter aus Edelstahl AISI 304 - Sicherheitsmikroschalter an Griff, Einführöffnung und Behälter - doppelter Einführöffnung für Produkteinführung - ovale Einführöffnung ~ 150x70 mm - runde Einführöffnung ø 56 mm. Das verarbeitete Produkt fällt direkt in den Sammelbehälter, ohne dass die Auswurfscheibe verwendet werden muss, wodurch die Integrität des Produkts erhalten bleibt. Kann mit einem verbesserten Motor ausgestattet werden, für die Verarbeitung kompakter Käsesorten.

ES Máquina para cortar, rebanar y rallar.
TV4000 - "L'ortolana": carcasa, boca y contenedor de recogida de acero inoxidable AISI 304 - microinterruptores de seguridad en la manija, boca y contenedor - boca ovalada ~ 150x70 mm - boca redonda ø 56 mm. El producto elaborado cae directamente en el contenedor sin utilizar el disco expulsor, dejando el producto intacto e inalterado. Opción de motor mejorado para la elaboración de quesos de consistencia compacta.

RU Машина для резки, склеивания и гратирования.
TV4000 "L'ortolana": корпус, входная и приемная ёмкость из нержавеющей стали AISI 304 - микровыключатели безопасности на ручке, входе и контейнере - двойной вход для вставки продукта - овальный вход ~ 150x70 мм - круглый вход ø 56 мм. Обработанный продукт попадает непосредственно в приемную емкость без необходимости использования выталкивающего диска, сохраняя целостность продукта. Наличие модернизированного двигателя для обработки сыров с плотной консистенцией.

TV4000	
	0,45 kW (0,6 HP)
	230-400V/3N/50Hz
	230V/1N/50Hz
	310 rpm
	ø 240 x 165(h) mm - 7,40 L
	280 x 630 x 550(h) mm
	
	27 Kg
	34 Kg
	370 x 670 x 630(h) mm
	0,156 m³
	
Dischi esclusi Disks not included Disques non fournis Einsatzscheiben nicht enthalten Discos no incluidos Диски не включены	Kit 5 dischi Set of 5 disks Kit de 5 disques Satz von 5 Einsatzscheiben Kit de 5 discos Набор из 5 дисков A2 - E10 - K10 - H10 - Z4

Special Voltages - Разное питающее напряжение

Motore potenziato- Powered motor - модернизированного двигателя
0,65 kW (0,89 HP)

OPTIONAL



192



187

TV2000RN LA ROMAGNOLA



TV2000RN



Tagliaverdura
con bocca estraibile

VEGETABLE CUTTER
COUPE-LÉGUMES
GEMÜSESCHNEIDER
CORTADORAS DE HORTALIZAS
ОВОЩЕПЕЗКА



IT Macchina per tagliare, affettare frutta, ortaggi, verdure in varie forme e misure, grattugiare formaggio, pane secco, nocciole, sfilacciare carote, sedano, patate, mele, rape, barbabietole, mozzarella.

TV2000RN chiamato "La Romagnola": presente da oltre 30 anni sui mercati internazionali, ancora più funzionale e versatile. Carcassa e bocca removibile in acciaio inox AISI 304 - microinterruttore di sicurezza su maniglia e bocca - doppia bocca inserimento prodotto - dimensione bocca ovale ~ 155x75 mm - dimensione bocca tonda ø 56 mm. Possibilità di avere un motore potenziato utile per la lavorazione di formaggi con consistenza compatta.

EN Machine for cutting, slicing fruit and vegetables in various shapes and sizes, grating cheese, dry bread, hazelnuts, shredding carrots, celery, potatoes, apples, turnips, beets, mozzarella.

TV2000RN - La Romagnola: with over 30 years of history on international markets, even more functional and versatile. Removable stainless steel AISI 304 casing and inlet - safety microswitch on handle and inlet - double inlet for product insertion - oval inlet size ~ 155x75 mm - round inlet size ø 56 mm. Powered motor useful for processing cheeses with a compact consistency also available.

FR Machine pour couper, trancher des fruits et légumes de différentes formes et tailles, râper du fromage, du pain sec, des noisettes, effilocheur des carottes, céleri, pommes de terre, pommes, navets, betteraves, mozzarella.

TV2000RN - La Romagnola: avec plus de 30 ans d'histoire sur les marchés internationaux, encore plus fonctionnelle et versatile. Corps et orifice d'entrée amovibles en acier Inox AISI 304 - micro-interrupteur de sécurité sur la poignée et l'orifice d'entrée - double orifice d'entrée pour l'insertion du produit - dimensions du orifice d'entrée oval ~ 155x75 mm- orifice rond ø 56 mm. Possibilité d'avoir un moteur plus performant, utile pour le traitement des fromages à consistance compacte.













DE Maschine zum Zerkleinern und Schneiden von Obst und Gemüse in verschiedenen Formen und Größen, Reiben von Käse, trockenem Brot, Haselnüssen, Zerkleinern von Karotten, Sellerie, Kartoffeln, Äpfeln, Rüben, Rote Beete, Mozzarella.

TV2000RN - La Romagnola: seit über 30 Jahren auf internationalen Märkten bekannt, jetzt noch leistungsfähiger und vielseitiger. Abnehmbares Gehäuse und Einführöffnung aus Edelstahl AISI 304 - Sicherheitsmikroschalter an Griff und Einführöffnung - doppelte Einführöffnung für Produkteinführung - ovale Einführöffnungsgröße ~ 155x75 mm- runde Einführöffnungsgröße ø 56 mm. Produkts erhalten bleibt. Kann mit einem verbesserten Motor ausgestattet werden, für die Verarbeitung kompakter Käsesorten.

ES Máquina para cortar, rebanar frutas, hortalizas, verduras de diferentes formas y medidas, rallar queso, pan seco, avellanas, cortar en tiras zanahorias, apio, patatas, manzanas, nabos, remolachas, mozzarella.

TV2000RN La Romagnola: Restyling de la cortadora de verdura TV2000 "La Romagnola", un modelo que desde hace 30 años tiene mucho éxito en el mercado internacional. Carcasa y boca extraíble de acero inoxidable AISI 304 - microinterruptor de seguridad en la manija y en la boca - boca doble para la introducción del producto. Dimensión boca ovalada ~ 155x75 mm- dimensión boca redonda ø 56 mm. Opción de motor mejorado para la elaboración de quesos de consistencia compacta.

Motore potenziato- Powered motor - модернизированного двигателя
0,65 kW (0,89 HP)

	TV2000RN	
	0,45 kW (0,6 HP)	
	230-400V/3/50Hz	
	230V/1N/50Hz	
	255 rpm	
	220 x 610 x 520(h) mm	
		
	22 Kg	
	24 Kg	
	300 x 620 x 580(h) mm	
	0,108 m³	
		
	Dischi esclusi Disks not included Disques non fournis Einsatzscheiben nicht enthalten Discos no incluidos Диски не включены	Kit 5 dischi Set of 5 disks Kit de 5 disques Satz von 5 Einsatzscheiben Kit de 5 discos Набор из 5 дисков A2 - E10 - D10 - H10 - Z4

Special Voltages - Разное питающее напряжение

RU Машина для нарезки, измельчения фруктов и овощей различных форм и размеров, нарезания сыра, сухого хлеба, лесных орехов, моркови, сельдерея, картофеля, яблок, репы, свеклы, моцареллы.
TV2000RN - La Romagnola: с более чем 30-летней историей на международных рынках, еще более функциональный и универсальный. Съёмный корпус и вход из нержавеющей стали AISI 304 - безопасный микровыключатель на ручке и входе - двойной вход для ввода продукта - овальный размер входа ~ 155x75 мм - круглый размер входа ø 56 мм. Наличие модернизированного двигателя для обработки сыров с плотной консистенцией.

TV3000N
TV2500



TV3000N



TV2500

Tagliaverdura

VEGETABLE CUTTER
COUPE-LÉGUMES
GEMÜSESCHNEIDER
CORTADORAS DE HORTALIZAS
ОВОЩЕРЕЗКА

IT Macchina per tagliare, affettare frutta, ortaggi, verdure in varie forme e misure, grattugiare formaggio, pane secco, nocciole, sfilacciare carote, sedano, patate, mele, rape, barbabietole, mozzarella. Microinterruttore di sicurezza su maniglia - doppia bocca inserimento prodotto. Dimensioni bocca ovale ~ 155x75 mm, dimensioni bocca tonda ø 56 mm. TV3000N è dotato di carcassa e bocca in acciaio inox AISI 430. TV2500 è dotato di carcassa rivestita con vernice poliuretanica antigraffio - bocca in materiale plastico idoneo al contatto con gli alimenti. Possibilità di avere un motore potenziato utile per la lavorazione di formaggi con consistenza compatta.













EN Machine for cutting, slicing fruit and vegetables in various shapes and sizes, grating cheese, dry bread, hazelnuts, shredding carrots, celery, potatoes, apples, turnips, beets, mozzarella. Safety microswitch on handle - double inlet for product insertion. Oval inlet size ~ 155x75 mm- round inlet size ø 56 mm. TV3000N with casing and inlet in stainless steel AISI 430. TV2500 is supplied with a casing coated with anti-scratch polyurethane paint - plastic inlet suitable for food contact. Powered motor useful for processing cheeses with a compact consistency also available.

FR Machine pour couper, trancher des fruits et légumes de différentes formes et tailles, râper du fromage, du pain sec, des noisettes, effilocheur des carottes, céleri, pommes de terre, pommes, navets, betteraves, mozzarella. Micro-interrupteur de sécurité sur la poignée - double orifice d'entrée pour l'insertion du produit. Dimensions orifice d'entrée oval ~ 155x75 mm - orifice rond ø 56 mm. TV3000N est équipé de corps et orifice d'entrée en acier Inox AISI 430. TV2500 est livré avec un corps revêtu d'une peinture polyuréthane anti-rayures - orifice d'entrée en matière plastique pour les produits alimentaires. Possibilité d'avoir un moteur plus performant, utile pour le traitement des fromages à consistance compacte.

DE Maschine zum Zerkleinern und Schneiden von Obst und Gemüse in verschiedenen Formen und Größen, Reiben von Käse, trockenem Brot, Haselnüssen, Zerkleinern von Karotten, Sellerie, Kartoffeln, Äpfeln, Rüben, Rote Beete, Mozzarella. Sicherheitsmikroschalter am Griff - doppelte Einführöffnung für Produkteinführung. Ovale Einführöffnungsgröße ~ 155x75 mm - runde Einführöffnungsgröße ø 56 mm. TV3000N wird mit Gehäuse und Einführöffnung aus Edelstahl AISI 430 geliefert. TV2500 wird mit einem mit kratzfester Polyurethanfarbe beschichteten Gehäuse geliefert - Kunststoff-einführöffnung lebensmitteleuglich. Kann mit einem verbesserten Motor ausgestattet werden, für die Verarbeitung kompakter Käsesorten.

ES Máquina para cortar, rebanar frutas, hortalizas, verduras de diferentes formas y medidas, rallar queso, pan seco, avellanas, cortar en tiras zanahorias, apio, patatas, manzanas, nabos, remolachas, mozzarella. Microinterrupor de seguridad en la manija - boca doble para la introducción del producto. Dimensión boca ovalada ~ 155x75 mm - dimensión boca redonda ø 56 mm. TV3000N: Carcasa y boca de acero inoxidable AISI 430. TV2500: Carcasa revestida con pintura poliuretánica antirayado - boca de material plástico idóneo para el contacto con los alimentos. Opción de motor mejorado para la elaboración de quesos de consistencia compacta.

RU Машина для нарезки, измельчения фруктов и овощей различных форм и размеров, нарезания сыра, сухого хлеба, лесных орехов, моркови, сельдерея, картофеля, яблок, репы, свеклы, моцареллы. Микровыключатель безопасности на ручке - Двойное вставное отверстие для вставки продукта. Овальное установочное отверстие ~ 155x75 мм - Размер круглого установочного отверстия ø 56 мм. TV3000N поставляется с корпусом из нержавеющей стали AISI 430 и вставным отверстием. TV2500 поставляется с корпусом, покрытым стойкой к царапинам полиуретановой краской - пластиковое отверстие для подачи продукта. Наличие модернизированного двигателя для обработки сыров с плотной консистенцией.

	TV3000N	TV2500
	0,45 kW (0,6 HP)	
	230-400V/3/50Hz	-
	230V/1N/50Hz	
	255 rpm	
	220 x 610 x 520(h) mm	
		
	22 Kg	
	24 Kg	
	300 x 620 x 580(h) mm	
	0,108 m³	
		
Dischi esclusi - Disks not included - Disques non fournis - Einsatzscheiben nicht enthalten - Discos no incluidos - Диски не включены		

Kit 5 dischi - Set of 5 disks - Kit de 5 disques - Satz von 5 Einsatzscheiben - Kit de 5 discos - Набор из 5 дисков
A2 - E10 - D10 - H10 - Z4

Special Voltages - Разное питающее напряжение

Motore potenziato - Powered motor - модернизированного двигателя
0,65 kW (0,89 HP)

IT DISCHI PER AFFETTARE

E1 - A2 - S1 - S2: Patate chips, rape, cavoli, cetrioli, carote bollite, cipolle, funghi.
E3: mele, banane, patate, zucchine, melanzane, finocchi, carciofi.
E4 - E6: barbabietole, patate, cavoli, rape, cipolle.
E5: pomodori, limoni, arance, mele, ananas, pompelmi.
E8 - E10 - E14: carote bollite, patate, melanzane, barbabietole.

DISCHI PER SFILACCIARE/GRATTUGIARE

Z2 - Z3: carote, sedano, patate, mele, rape.
Z4: barbabietole, radici, formaggio tipo groviera.
V: parmigiano, pane secco, mandorle, noci, nocciole.
Z7: mozzarella.

DISCHI PER TAGLIO A CUBETTI

La combinazione dei dischi D8x8 - D10x10 - D12x12 - D20x20 - K8x8 - K10x10 - K12x12 - K20x20 con i dischi E6 - E8 - E10 - E14 permette di ottenere una vastissima serie di cubetti per minestrone e macedonie.

DISCHI PER TAGLIO A FIAMMIFERO

H25 - H4 - H6 - H8 - H10: sedano, zucchine, barbabietole, radici, patate, rape.
La combinazione dei dischi B6 - B8 - B10 con i dischi E6 - E8 - E10 permette di ottenere fiammiferi per tutta la lunghezza del prodotto con lo spessore desiderato.

EN SLICING DISCS

E1 - A2 - S1 - S2: potatoes chips, turnips, cabbages, cucumbers, boiled carrots, onions, mushrooms.
E3: apples, bananas, potatoes, courgettes, aubergines, fennels, artichokes.
E4 - E6: beetroot, potatoes, cabbage, turnips and onions.
E5: tomatoes, lemons, oranges, apples, pineapples and grapefruits.
E8 - E10 - E14: boiled carrots, potatoes, aubergines and beetroot.

SHREDDING/GRATING DISCS

Z2 - Z3: carrots, celery, potatoes, apples and turnips.
Z4: beetroots, radishes, gruyere-type cheese.
V: parmesan, dry bread, almonds, nuts, hazelnuts.
Z7: mozzarella.

CUBE CUTTING DISCS

The combination of discs D8x8 - D10x10 - D12x12 - D20x20 - K8x8 - K10x10 - K12x12 - K20x20 with discs E6 - E8 - E10 - E14 obtains a vast number of different types of cubes for minestrone and fruit salads.

SHOESTRING CUTTING DISCS

H25 - H4 - H6 - H8 - H10: celery, courgettes, beetroot, radishes, potatoes and turnips.
The combination of the discs B6 - B8 - B10 with the discs E6 - E8 - E10 allows to obtain shoestrings for the whole length of the product with the desired thickness.

FR DISQUES A COUPER

E1 - A2 - S1 - S2: frites, céleri-rave, chou, concombres, carotte bouillie, oignons, champignons.
E3: pommes, bananes, pommes de terre, courgettes, aubergines, fenouils, artichauts.
E4 - E6: betteraves, pommes de terre, carottes bouillies, chou, céleris-raves, oignons.
E5: tomates, citrons, oranges, pommes, ananas, pamplemousses.
E8 - E10 - E14: pommes de terre et carottes bouillies, aubergines, betteraves.

DISQUES À RÂPER / EFFILOCHER

Z2 - Z3: carottes, céleri, pommes de terre, pommes, céleris-raves.
Z4: betteraves, radis, fromage de type gruyère.
V: parmesan, pain sec, amandes, noix, noisettes.
Z7: mozzarella.

DISQUES POUR LE DÉCOUPAGE EN PETITS CUBES

La combinaison des disques D8x8 - D10x10 - D12x12 - D20x20 - K8x8 - K10x10 - K12x12 - K20x20 avec les E6 - E8 - E10 - E14 permet d'obtenir une grande variété de cubes pour minestrone et salades de fruits.

DISQUES POUR TAILLER EN JULIENNE

H25 - H4 - H6 - H8 - H10: céleri, courgettes, betteraves, radis, pommes de terre, céleris-raves. La combinaison des disques B6 - B8 - B10 aux E6 - E8 - E10 permet d'obtenir une julienne sur toute la longueur du produit avec l'épaisseur souhaitée.

DE SCHNEIDSCHLEIBEN FÜR SCHEIBEN

E1 - A2 - S1 - S2: Kartoffelchips, Rüben, Kohlköpfe, Gurken, gekochte Karotten, Zwiebeln, Pilze.
E3: Äpfel, Bananen, Kartoffeln, Zucchini, Auberginen, Fenchel, Artischocken.
E4 - E6: Rote Beete, Salzkartoffeln, Kohl, Rüben und Zwiebeln.
E5: Tomaten, Zitronen, Orangen, Äpfel, Ananas und Grapefruits.
E8 - E10 - E14: Salzkartoffeln, gekochte Karotten, Auberginen und Rote Beete.

SCHNEIDSCHLEIBEN ZUM RASPELN UND REIBEN

Z2 - Z3: Karotten, Sellerie, Kartoffeln, Äpfel und Rüben.
Z4: Rote Beete, Rettich, Greyerzkerse.
V: Parmesan, trockenes Brot, Mandeln, Nüsse, Haselnüsse.
Z7: Mozzarella.

SCHNEIDSCHLEIBEN FÜR WÜRFEL

Aus der Kombination der Scheiben D8x8 - D10x10 - D12x12 - D20x20 - K8x8 - K10x10 - K12x12 - K20x20 mit den Scheiben E6 - E8 - E10 - E14 bekommt man eine Vielzahl von verschiedenen Arten von Würfeln für Minestrone und Obstsalate.

SCHNEIDSCHLEIBEN FÜR JULIENNESCHNITT

H25 - H4 - H6 - H8 - H10: Sellerie, Zucchini, Rote Beete, Wurzeln, Kartoffeln, Rüben. Aus der Kombination der Scheiben B6 - B8 - B10 mit den Scheiben E6 - E8 - E10 bekommt man Julienne-Streifen auf der gesamten Produktlänge in der gewünschten Dicke.

ES DISCOS PARA REBANAR

E1 - A2 - S1 - S2: Patatas chips, nabos, repollos, pepinos, zanahorias, cebollas y setas.
E3: Manzanas, bananas, patatas, calabacines, berenjenas, hinojos y alcachofas.
E4 - E6: Remolachas, patatas, repollos, nabos y cebollas.
E5: Tomates, limones, naranjas, manzanas, ananás y pomelos.
E8 - E10 - E14: zanahorias hervidas, patatas, zanahorias hervidas, berenjenas y remolachas.

DISCOS PARA DESMENUZAR O RALLAR

Z2 - Z3: Zanahorias, apio, patatas, manzanas y nabos.
Z4: Remolachas, achicorias, queso tipo gruyere.
V: Queso parmesano, pan seco, almendras, nueces, avellanas.
Z7: mozzarella.

DISCOS PARA CORTE EN CUBITOS

La combinación de los discos D8x8 - D10x10 - D12x12 - D20x20 - K8x8 - K10x10 - K12x12 - K20x20 con los discos E6 - E8 - E10 - E14 permite obtener una variadísima serie de cubitos para sopas y macedonias.

DISCOS PARA CORTE EN FORMA DE PAJA

H25 - H4 - H6 - H8 - H10: Apio, calabacines, remolacha, achicorias, patatas y nabos. La combinación de los discos B6 - B8 - B10 con los discos E6 - E8 - E10 permite obtener bastoncillos tan largos como el producto y con el espesor deseado.

RU СЛИЦИНГИРОВАННЫЕ ДИСКИ

E1 - A2 - S1 - S2: картофельные чипсы, репа, капуста, огурцы, морковь, лук, шампиньоны.
E3: яблоки, бананы, картофель, кабачки, баклажаны, фенхель, артишоки.
E4 - E6: свекла, отварной картофель, капуста, репа и лук.
E5: помидоры, лимоны, апельсины, яблоки, ананасы и грейпфруты.
E8 - E10 - E14: отварной картофель и морковь, баклажаны и свекла.

ИЗМЕЛЬЧАЮЩИЕ/ОТРАЖАЮЩИЕ ДИСКИ

Z2 - Z3: морковь, сельдерей, картофель, яблоки и репа.
Z4: свекла, редис, сыр грюйер.
V: пармезан, сухой хлеб, миндаль, орехи, лесные орехи.
Z7: Моцарелла.

КУБИЧЕСКИЕ ОТРЕЗНЫЕ КРУГИ

Комбинация дисков D8x8 - D10x10 - D12x12 - D20x20 - K8x8 - K10x10 - K12x12 - K20x20 с дисками E6 - E8 - E10 - E14 получает огромное количество различных типов кубиков, для минстрона и фруктовых салатов.

ОТРЕЗНЫЕ ДИСКИ ДЛЯ ОБУВИ

H25 - H4 - H6 - H8 - H10: сельдерей, кабачки, свекла, редис, картофель и репа. Комбинация дисков B6 - B8 - B10 с дисками E6 - E8 - E10 позволяет получить струны обуви по всей длине изделия необходимой толщины.



E1



E3



E5



E8



E14



S2



Z2



Z3



Z4



Z7



V

OPTIONAL



D12

K10

K20



B10

B8

H25

Per ottenere il fiammifero accoppiare il disco E con il disco B.
 To obtain the shoestring, combine disc E with disc B.
 Pour couper en julienne utiliser le disque E avec le disque B.
 Um Stäbchen zu erhalten, die Einsatzscheiben E und B zusammen verwenden.
 Para obtener la forma de paja combinar el disco E con el disco B.
 Чтобы получить рукоятку, соедините диск E с диском B.



DISCO E

DISCO B

Per ottenere il cubetto accoppiare il disco E con il disco D.
 To obtain the cube, combine disc E with disc D.
 Pour couper le petit cube utiliser le disque E avec le disque D.
 Um Würfel zu erhalten, die Einsatzscheiben E und D zusammen verwenden.
 Para obtener el cubito combinar el disco E con el disco D.
 Для нарезки кубиками использовать диск E вместе D диском K.



DISCO E

DISCO D

SOLO PER MODELLO TV4000 / MODEL TV4000 ONLY

Per ottenere il cubetto accoppiare il disco E con il disco K.
 To obtain the cube, combine disc E with disc K.
 Pour couper le petit cube utiliser le disque E avec le disque K.
 Um Würfel zu erhalten, die Einsatzscheiben E und K zusammen verwenden.
 Para obtener el cubito combinar el disco E con el disco K.
 Для нарезки кубиками использовать диск E вместе K диском K.



DISCO E

DISCO K

	DISCO E1 - A2 - E3 - E4 - E5 E6 - E8 - E10 - E14 S1 - S2	DISCO Z2 - Z3 - Z4 - Z7	DISCOV	DISCO H25 - H4 - H6 H8 - H10	DISCO B6 - B8 - B10
	Dischi per affettare Slicing disk Disques à trancher Schneidescheiben Discos para cortar Отрезные диски	Dischi per sfilacciare Shredding discs Disques à effiloche Schneidescheiben zum Raspeln Discos para desmenuzar Измельчающие диски	Dischi per grattugiare Grating discs Disques à râper Schneidescheiben zum Reiben Discos para rallar Отражающие диски	Dischi per taglio a fiammifero Shoestring cutting discs Disques à julienne Julienneschnitt Scheiben Discos para corte en forma de paja Нож для нарезания палочками	
TV2000RN TV3000N TV2500					
TV4000					
FNT - FNT2V					

	DISCOD8 DISCOD10 (DX)	DISCOD8S DISCOD10S (SX)	DISCOD12 DISCOD20 (DX)	DISCOD12S DISCOD20S (SX)	DISCOK8 DISCOK10 DISCOK12 DISCOK20
	Dischi per taglio a cubetti - Cubes cutting discs - Disque pour couper en dés Würfelschneidescheiben - Discos para corte en cubitos - Кубические Отрезные Круги				
TV2000RN TV3000N TV2500					
TV4000					
FNT - FNT2V					

	PORTADISCHI
	Portadischi - Disk holder Porte-disques - Scheibenständer Portadiscos - Держатель дисков
Mod.	TV2000RN - TV3000N - TV2500 TV4000 - FNT - FNT2V



PORTADISCHI

OPTIONAL

TAC-TAS



Tagliamozzarella

MOZZARELLA CUTTER
COUPE-MOZZARELLA
MOZZARELLASCHNEIDER
CORTADORAS DE MOZZARELLA
КУСАЧЕК МОЦАРЕЛЛЫ

IT Macchina realizzata appositamente per cubettare (TAC) e sfilacciare (TAS) mozzarella. Carcassa in acciaio inox AISI 304 - corpo centrale e coperchio in alluminio anodizzato - dimensione bocca ~ 80x65 mm - microinterruttori di sicurezza su coperchio e maniglia.

TAC: in base ai dischi utilizzati si ottengono diverse misure di cubetti.

TAS: in base all'utilizzo dei vari dischi si ottiene sia una sfilacciatura mista che un taglio a spaghetti.

EN Machine specifically designed for cutting mozzarella into small cubes (TAC) and shredding (TAS). Stainless steel casing AISI 304 - central case and lid in anodized aluminium - inlet size ~ 80x65 mm - safety microswitches on lid and handle.

TAC: depending on the discs used, different sizes of cubes are obtained.

TAS: depending on the discs used, both mixed shredding and shoestring cutting are obtained.

FR Machine conçue spécifiquement pour le coupage en petits cubes (TAC) et le filetage (TAS) de la mozzarella. Corps en acier Inox AISI 304 - corps central et couvercle en aluminium anodisé - dimensions orifice d'entrée ~ 80x65 mm - microrupteurs de sécurité sur le couvercle et la poignée.

TAC: en fonction des disques utilisés, différentes tailles de cubes sont obtenues.

TAS: en fonction des disques utilisé, on obtient aussi bien l'effilochage mixte que la coupe à julienne.

DE Maschine, die speziell für das Schneiden von Mozzarella in kleine Würfel (TAC) und das Zerkleinern (TAS) entwickelt wurde. Gehäuse aus Edelstahl AISI 304 - zentraler Körper und Deckel aus eloxiertem Aluminium - Einführöffnunggröße ~ 80x65 mm - Sicherheitsmikroschalter an Deckel und Griff.

TAC: je nach verwendeter Scheibe werden unterschiedliche Größen von Würfeln erzielt.

TAS: je nach verwendeter Scheibe werden sowohl gemischte Zerkleinerung als auch Stäbchen realisiert.

ES Máquinas realizadas especialmente para desmenuzar / deshilachar (TAS) y cortar en cubitos. (TAC) la mozzarella. Carcasa de acero inoxidable AISI 304 - cuerpo central y tapa de aluminio - dimensión boca ~ 80x65 mm - microinterruptores de seguridad en la tapa y la manija.





TAS: con el uso de los diferentes discos se consiguen tanto un deshilachado mixto como un corte tipo espagueti.

TAC: con el uso de los diferentes discos se consiguen diferentes tamaños de cubitos.

RU Машина специально разработана для резки моцареллы на маленькие кубики (TAC) и дробления (TAS). Корпус из нержавеющей стали AISI 304 - центральный корпус и крышка из анодированного алюминия - вставное отверстие ~ 80x65 мм - микровыключатель безопасности на крышке и ручке.

TAC: в зависимости от используемого диска получаются кубики разных размеров.

TAS: в зависимости от используемого диска производится как смешанное измельчение, так и палочки.

	TAC	TAS
	0,4 kW (0,55 HP) - 1 PH 0,45 kW (0,6 HP) - 3 PH	0,3 kW (0,4 HP) - 1 PH 0,35 kW (0,5 HP) - 3 PH
	230-400V/3/50Hz	
	230V/1N/50Hz	
	140 rpm	300 rpm
	120÷190 Kg/h	250÷300 Kg/h
	330 x 380 x 690(h) mm	
		
	17 Kg	15 Kg
	19 Kg	17 Kg
	430 x 400 x 800(h) mm	
	0,138 m³	

Special Voltages - Разное питающее напряжение

Optional

ACCESSORIES
ACCESSOIRES
ZUBEHÖR
ACCESORIOS
AKCECCYAPЫ

TAS	DISCO4PZ5 5 mm	DISCO4PZ8 8 mm	DISCOPZ4 ø 4 mm	DISCOPZ7 ø 7 mm
	Disco 4 lame ondulate - 4 blades corrugated disk Disque 4 lames ondulées - Scheibe mit 4 gewellten Messern Disco de 4 cuchilla onduladas - Диск 4 рифлёные лезвия		Disco per sfilacciare - Cutting disk for shreds Disque pour effiler - Scheibe zum Zerkleinern Disco para cortar en tiras - Диск для измельчения	

TAC	NPD 5 mm	NPD 8 mm	COLP5 5 mm	COLP8 8 mm
	Dischi - Disks - Disques - Scheiben - DiscoS - Диск		Coltello solo per disco NPD - Knife for the NPD disks series only Couteau uniquement pour disque NPD - Messer nur für Scheibe NPD Cuchilla solo para disco NPD - Нож только для диска NPD	
	DISCONPD85	8 x 8 x 5 mm	DISCONPD88	8 x 8 x 8 mm
	DISCONPD105	10 x 10 x 5 mm	DISCONPD108	10 x 10 x 8 mm
	DISCONPD125	12 x 12 x 5 mm	DISCONPD128	12 x 12 x 8 mm
	DISCONPD165	16 x 16 x 5 mm	DISCONPD168	16 x 16 x 8 mm
	DISCONPD205	20 x 20 x 5 mm	DISCONPD208	20 x 20 x 8 mm



DISCO4PZ8



DISCOPZ4



DISCOPZ7

MODELLO TAS / ONLY MODEL TAS

Può utilizzare anche i dischi della serie E-H-Z-V.
May also be used with the discs of the series E-H-Z-V.
Peut également utiliser les disques de la série E-H-Z-V.
Kann auch die Scheiben der Serie E-H-Z-V verwenden.
Pueden usarse también los discos de la serie E-H-Z-V.
Можно также использовать диски серии E-H-Z-V.



COLP5



DISCONPD88



CL3N-CL5N-CL8N CL5NV2-CL8NV2



CL5N



CL5NV2



GUARDA IL VIDEO
WATCH THE VIDEO

IT Macchina per tritare, impastare, sminuzzare e mescolare. Carcassa e vasca in acciaio inox AISI 304 - coperchio superiore in policarbonato alimentare trasparente - pulsantiera a pressione - microinterruttori di sicurezza sul coperchio e sulla base d'appoggio vasca - freno motore - capacità vasca 3-5-8 litri - dotato di un coltello a 2 lame taglienti.
CL5NV2 - CL8NV2: doppia velocità.

FR Machine pour hacher, triturer, homogénéiser et mélanger. Corps et cuve en acier Inox AISI 304 - couvercle supérieur en polycarbonate alimentaire transparent - interrupteur à pression - microinterrupteur de sécurité sur le couvercle et le pied support cuve - frein moteur - capacité cuve 3-5-8 litres - équipé d'un couteau avec 2 lames pointues.
CL5NV2 - CL8NV2: double vitesse.













ES Máquina para amasar, desmenuzar y mezclar. Carcasa y bol de acero inoxidable AISI 304 - tapa superior de policarbonato transparente para alimentos - botonera a presión - microinterruptores de seguridad en la tapa y en el soporte del bol - freno motor - capacidad del bol 3-5-8 litros - en la dotación un cuchillo de dos hojas cortantes.
CL5NV2 - CL8NV2: doble velocidad.

EN Machine for shredding, kneading, chopping and mixing. Casing and bowl in stainless steel AISI 304 - upper lid in clear alimentary polycarbonate - pressure switch - safety microswitches on lid and bowl support base - motor brake - bowl capacity 3-5-8 litres - equipped with a knife with 2 sharp blades.
CL5NV2 - CL8NV2: double speed.

DE Maschine zum Zerkleinern, Kneten, Häckseln und Mischen. Gehäuse und Schüssel aus Edelstahl AISI 304 - oberer Deckel aus durchsichtigem lebensmitteltauglichem Polykarbonat - Druckknopf - Sicherheitsmikroschalter am Deckel und Schüsselträgerfuß - Motorbremse - Schüsselinhalt 3-5-8 Liter - ausgestattet mit einem Messer mit 2 scharfen Klingen.
CL5NV2 - CL8NV2: doppelte Geschwindigkeit.

RU Машина для дробления, перемешивания, измельчения и смешивания. Корпус и чаша из нержавеющей стали AISI 304 - прозрачная верхняя крышка из поликарбоната - реле давления - предохранительный микровыключатель на крышке и опоре барабана - тормоз мотора - емкость барабана 3-5-8 литров - оснащен ножом с 2 острыми лезвиями.
CL5NV2 - CL8NV2: двойная скорость.



	CL3N	CL5N	CL8N	CL5NV2	CL8NV2
	0,75 kW (1 HP)			0,6-0,8 kW (0,8 -1,1 HP)	
	230-400V/3N/50Hz			400V/3N/50Hz	
	230V/1N/50Hz			-	
	1400 rpm			1400 rpm - 1400/2800 rpm - 2nd speed	
	3 L ø 210 x 105(h) mm liquidi/ liquids max. 1,8 L	5 L ø 210 x 160(h) mm liquidi/ liquids max. 2,1 L	8 L ø 210 x 205(h) mm liquidi/ liquids max. 2,4 L	5 L ø 210 x 160(h) mm liquidi/ liquids max. 2,1 L	8 L ø 210 x 205(h) mm liquidi/ liquids max. 2,4 L
	240 x 310 x 485(h) mm	240 x 310 x 545(h) mm	240 x 310 x 595(h) mm	240 x 310 x 545(h) mm	240 x 310 x 595(h) mm
					
	18 Kg	19 Kg		21 Kg	
	20 Kg	21 Kg		23 Kg	
	400 x 300 x 670(h) mm				
	0,080 m³				

Special Voltages - Разное питающее напряжение

CL3N

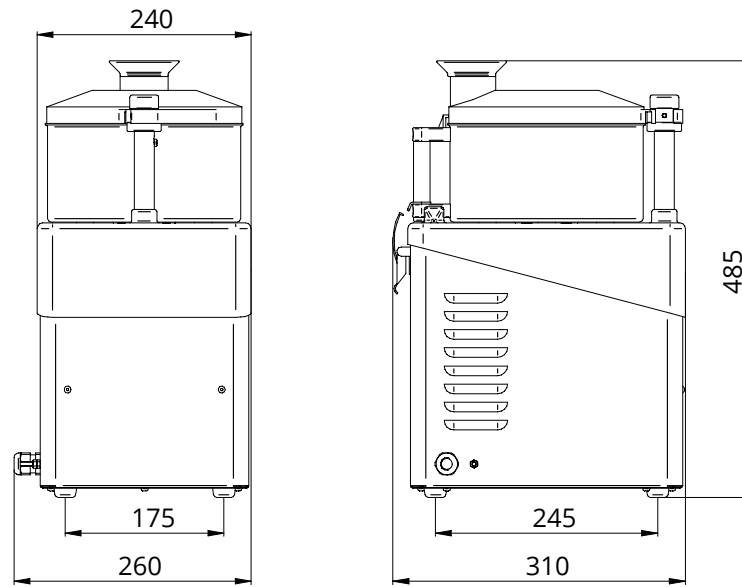

CL5N - CL5NV2

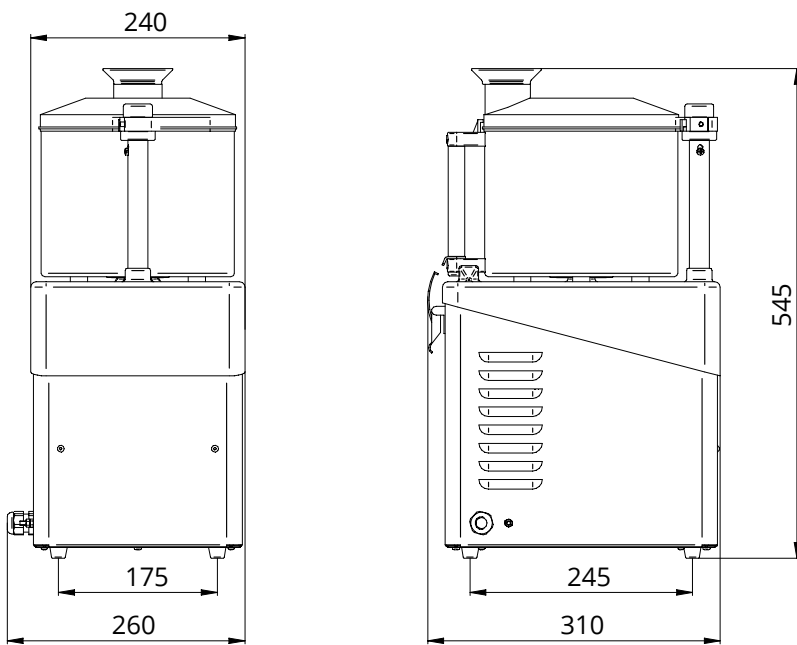

CL8N - CL8NV2

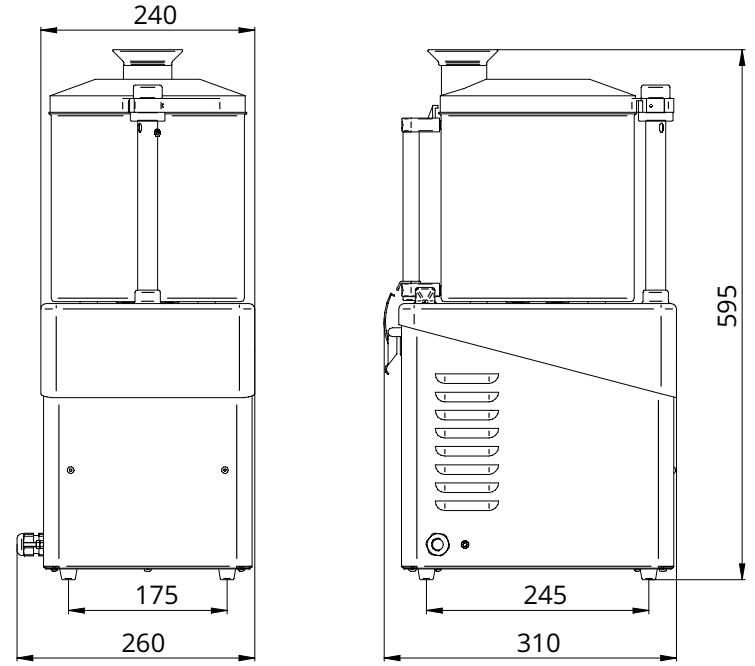

BC3N-BC5N-BC8N BC5NV-BC8NV



Cutter

IT Carcassa in alluminio anodizzato - vasca e lame estraibili in acciaio inox - coperchio superiore in policarbonato alimentare trasparente - microinterruttori di sicurezza su coperchio e vasca - capacità vasca 3-5-8 litri - dotato di coltello a 2 lame taglienti.
BC5NV - BC8NV: variatore di velocità.

FR Corps en aluminium anodisé - cuve et lames amovibles en acier Inox - couvercle supérieur en polycarbonate alimentaire transparent - micro-interrupteur de sécurité sur le couvercle et la cuve - capacité cuve 3-5-8 litres - équipé d'un couteau avec 2 lames pointues.
BC5NV - BC8NV: variateur de vitesse.

ES Carcasa de aluminio anodizado - bol y cuchillas extraíbles de acero inoxidable AISI 304 - tapa superior de policarbonato transparente para alimentos - microinterruptores de seguridad en la tapa y el bol - capacidad del bol 3-5-8 litros - dotado de cuchillo con 2 hojas cortantes.
BC5NV - BC8NV: variador de velocidad.

EN Anodized aluminium casing - removable stainless steel bowl and blades - upper lid in clear alimentary polycarbonate - safety microswitches on lid and bowl - bowl capacity 3-5-8 litres - equipped with a knife with 2 sharp blades.
BC5NV - BC8NV: variable speed drive.

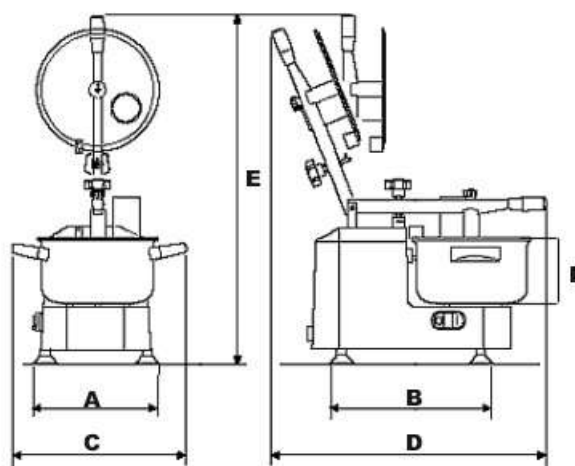

DE Eloxiertes Aluminiumgehäuse - abnehmbare Edelstahlschüssel und -klingen - oberer Deckel aus durchsichtigem lebensmitteleuglichem Polykarbonat - Druckknopf - Sicherheitsmikroschalter am Deckel und Schüsselträgerfuß - Motorbremse - Schüsselinhalt 3-5-8 Liter - ausgestattet mit einem Messer mit 2 scharfen Klingen.
BC5NV - BC8NV: Variator der Geschwindigkeit.

RU Корпус из анодированного алюминия - Съемная чаша и лезвия из нержавеющей стали - прозрачная верхняя крышка из поликарбоната - кнопка - предохранительный микровыключатель на крышке и опорной лапке - моторный тормоз - объем барабана 3-5-8 литров - оснащен ножом с 2 острыми лезвиями.
BC5NV - BC8NV: двойная скорость.



	BC3N	BC5N	BC8N
A	200 mm	260 mm	
B	270 mm	360 mm	
C	320 mm	320 mm	
D	520 mm	710 mm	
E	620 mm	850 mm	900 mm
F	110 mm	160 mm	210 mm

	BC5NV	BC8NV
A	260 mm	
B	360 mm	
C	320 mm	
D	710 mm	
E	850 mm	900 mm
F	160 mm	210 mm



	BC3N	BC5N	BC8N	BC5NV	BC8NV
	0,37 kW (0,5 HP)	0,75 kW (1 HP)			
	230V/1N/50Hz				
	1300 rpm			260÷2120 rpm	
	3 L ø 210 x 110 (h) mm liquidi/ liquids max. 1,7 L	5 L ø 210 x 160(h) mm liquidi/ liquids max. 2,8 L	8 L ø 210 x 210(h) mm liquidi/ liquids max. 4 L	5 L ø 210 x 160(h) mm liquidi/ liquids max. 2,8 L	8 L ø 210 x 210(h) mm liquidi/ liquids max. 4 L
	520 x 320 x 620(h) mm	710 x 320 x 850(h) mm	710 x 320 x 900(h) mm	710 x 320 x 850(h) mm	710 x 320 x 900(h) mm
					
	12 Kg	24 Kg	25 Kg	24 Kg	25 Kg
	13,5 Kg	26 Kg	27 Kg	26 Kg	27 Kg
	470 x 380 x 380(h) mm	485 x 630 x 530(h) mm	485 x 630 x 550(h) mm	485 x 630 x 530(h) mm	485 x 630 x 550(h) mm
	0,067 m³	0,160 m³	0,170 m³	0,160 m³	0,170 m³

Special Voltages - Разное питающее напряжение

Optional

ACCESSORIES
ACCESSOIRES
ZUBEHÖR
ACCESORIOS
AKCECCYAPЫ

	COLCL3L2	COLCL58L2	COLCL3L2S	COLCL58L2S	COLBC3NL2	COLBC5NL2 COLBC8NL2	COLBC3NL2S	COLBC5NL2S COLBC8NL2S
	Coltello 2 lame - 2 blades knife - Couteau 2 lames - 2-Klingen-Messer - Cuchillo de 2 cuchillos - 2-лопастной нож							
Mod.	CL3N	CL5N-CL8N	CL3N	CL5N-CL8N	BC3N	BC5N - BC8N	BC3N	BC5N - BC8N
	Tagliante - cutting - tranchant - zum Schneiden - cortador - для нарезки		Sbattitore - mixing - batteur Mixer - batidor - смешивания		Tagliante - cutting - tranchant - zum Schneiden - cortador - для нарезки		Sbattitore - mixing - batteur Mixer - batidor - смешивания	
								

	COLCL58L4	COLCL58L4S	COLBC5NL4 COLBC8NL4	COLBC5NL4S COLBC8NL4S
	Coltello 4 lame - 4 blades knife - Couteau 4 lames - 4-Klingen-Messer - Cuchillo de 4 cuchillos - 4-лопастной нож			
Mod.	CL5N-CL8N		BC5N - BC8N	
	Tagliante - cutting - tranchant - zum Schneiden - cortador - для нарезки	Sbattitore - mixing - batteur Mixer - batidor - смешивания	Tagliante - cutting - tranchant - zum Schneiden - cortador - для нарезки	Sbattitore - mixing - batteur Mixer - batidor - смешивания
				

PPN5
PPF5



PPF5

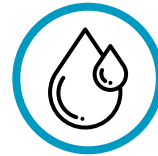

CARICO/SCARICO ACQUA
WATER INLET / OUTLET
ВХОД/ВЫХОД ВОДЫ





















PPN5

Pelapatate

POTATO PEELER
ÉPLUCHEUSE À POMMES DE TERRE
KARTOFFELSCHÄLER
PELAPAPAS
КАРТОФЕЛЕЧИСТКА

- IT** Macchina per pelare patate. Struttura in acciaio inox AISI 304 - coperchio superiore in policarbonato alimentare trasparente - microinterruttori di sicurezza su coperchio superiore e su bocca di uscita - pulsante espulsione prodotto - timer 0÷4 minuti - getto automatico d'acqua per favorire l'eliminazione dei residui di pelatura - in dotazione piattello abrasivo estraibile PTA. Il modello PPN5 è da banco.
- EN** Potato peeler. Structure in stainless steel AISI 304 - upper cover in clear alimentary polycarbonate - safety microswitches on the upper lid and on the inlet - product ejection button - timer 0÷4 minutes - automatic water jet to facilitate the elimination of peeling waste - extractable abrasive plate enclosed PTA. Table-top model PPN5.
- FR** Eplucheur de pommes de terre. Corps en acier Inox AISI 304 - couvercle supérieur en polycarbonate alimentaire transparent - micro-interrupteurs de sécurité sur le couvercle supérieur et sur l'orifice d'entrée - bouton d'éjection du produit - temporisateur 0÷4 minutes - jet d'eau automatique pour l'élimination du pelage - de série plaque abrasive extractible PTA. PPN5: modèle de table.
- DE** Kartoffelschäler. Gehäuse aus Edelstahl AISI 304 - oberer Deckel aus durchsichtigem, lebensmitteleuglichem Polycarbonat - Sicherheitsmikroschalter am oberen Deckel und an der Einführöffnung - Produktauswurfstaste - Timer 0÷4 Minuten - automatischer Wasserstrahl zur leichteren Abreinigung - abnehmbare Schleifplatte beigefügt PTA. Tischmodell PPN5.
- ES** Pelador de papas. Estructura de acero inoxidable AISI 304 - tapa superior de policarbonato transparente para alimentos - microinterruptores de seguridad en la tapa y la boca de salida - botón para la expulsión del producto - temporizador 0÷4 minutos - chorro de agua automático para favorecer la eliminación de los residuos de peladura - en la dotación plato abrasivo extraíble PTA. El modelo PPN5 es de sobremesa.
- RU** Очиститель картофеля. Конструкция из нержавеющей стали AISI 304 - верхняя крышка из прозрачного пищевого поликарбоната - предохранительные микровыключатели на верхней крышке и на входном отверстии - кнопка выброса продукта - таймер 0÷4 минуты - автоматическая струя воды для снятия пилинга - стандартная съемная абразивная плита ПТА. PPN5: настольная модель.

	PPN5	PPF5
	0,37 kW (0,5 HP)	
	230-400V/3N/50Hz	
	230V/1N/50Hz	
	± 5 Kg max	
	60 Kg/h	
	no	si / yes
	520 x 630 x 590(h) mm	520 x 700 x 1010(h) mm
		
	28 Kg	27 Kg
	39 Kg	38 Kg
	830 x 530 x 740(h) mm	
	0,326 m³	

	CI 560 x 380 x 440(h) mm	
	3,2 Kg	 4,7 Kg
	600 x 410 x 490(h) mm	 0,121 m³

Special Voltages - Разное питающее напряжение

OPTIONAL



PPN10M
PPF10M

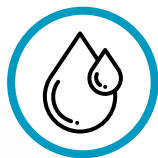

CARICO/SCARICO ACQUA
WATER INLET / OUTLET
ВХОД/ВЫХОД ВОДЫ



PPN10M
CON ABRASIVO LATERALE (OPTIONAL)
WITH LATERAL ABRASIVE (OPTIONAL)



PPF

Pelapatate

POTATO PEELER
ÉPLUCHEUSE À POMMES DE TERRE
KARTOFFELSCHÄLER
PELAPAPAS
КАРТОФЕЛЕЧИСТКА



GUARDA IL VIDEO
WATCH THE VIDEO

- IT** Macchina per pelare patate. Struttura in acciaio inox AISI 304 - coperchio superiore in policarbonato alimentare trasparente - microinterruttori di sicurezza su coperchio superiore e su bocca di uscita - pulsante espulsione prodotto - timer 0÷4 minuti - getto automatico d'acqua per favorire l'eliminazione dei residui di pelatura - in dotazione piatto abrasivo estraibile PTA.
- EN** Potato peeler. Structure in stainless steel AISI 304 - upper cover in clear alimentary polycarbonate - safety microswitches on the upper lid and on the inlet - product ejection button - timer 0÷4 minutes - automatic water jet to facilitate the elimination of peeling waste - extractable abrasive plate enclosed PTA.
- FR** Eplucheur de pommes de terre. Corps en acier Inox AISI 304 - couvercle supérieur en polycarbonate alimentaire transparent - micro-interrupteurs de sécurité sur le couvercle supérieur et sur l'orifice d'entrée - bouton d'éjection du produit - temporisateur 0÷4 minutes - jet d'eau automatique pour l'élimination du pelage - de série plaque abrasive extractible PTA.
- DE** Kartoffelschäler. Gehäuse aus Edelstahl AISI 304 - oberer Deckel aus durchsichtigem, lebensmitteleuglichem Polycarbonat - Sicherheitsmikroschalter am oberen Deckel und an der Einführöffnung - Produktauswurfstaste - Timer 0÷4 Minuten - automatischer Wasserstrahl zur leichteren Abreinigung - abnehmbare Schleifplatte beigefügt PTA.
- ES** Pelador de papas. Estructura de acero inoxidable AISI 304 - tapa superior de policarbonato transparente para alimentos - microinterruptores de seguridad en la tapa y la boca de salida - botón para la expulsión del producto - temporizador 0÷4 minutos - chorro de agua automático para favorecer la eliminación de los residuos de peladura - en la dotación plato abrasivo extraíble PTA.
- RU** Очиститель картофеля. Конструкция из нержавеющей стали AISI 304 - верхняя крышка из прозрачного пищевого поликарбоната - предохранительные микровыключатели на верхней крышке и на входном отверстии - кнопка выброса продукта - таймер 0÷4 минуты - автоматическая струя воды для снятия пилинга - стандартная съемная абразивная плита PTA.



OPTIONAL
CON ABRASIVO LATERALE
WITH LATERAL ABRASIVE

A		C1 560 x 380 x 440(h) mm	
NET Kg	3,2 Kg	GROSS Kg	4,7 Kg
mm	600 x 410 x 490(h) mm	m ³	0,121 m ³

i	PPN10M	PPF10M
⚡	0,75 kW (1 HP)	
⌚ 3 Ph	230-400V/3N/50Hz	
⚡ 1 Ph	230V/1N/50Hz	
Kg	± 10 Kg max	
Kg/h	120 Kg/h	
A	no	si / yes
mm	400 x 770 x 860(h) mm	380 x 770 x 1160(h) mm
🚚		
NET Kg	36 Kg	34 Kg
GROSS Kg	47 Kg	45 Kg
mm	830 x 530 x 1050(h) mm	830 x 530 x 740(h) mm
m ³	0,463 m ³	0,326 m ³

Special Voltages - Разное питающее напряжение

Con abrasivo laterale - With lateral abrasiv - С боковым абразивом

OPTIONAL



PPN18M
PPF18M

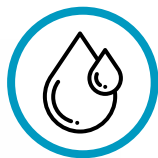

CARICO/SCARICO ACQUA
WATER INLET / OUTLET
ВХОД/ВЫХОД ВОДЫ



PPN
CON ABRASIVO LATERALE (OPTIONAL)
WITH LATERAL ABRASIVE (OPTIONAL)



PPF

Pelapatate

POTATO PEELER
ÉPLUCHEUSE À POMMES DE TERRE
KARTOFFELSCHÄLER
PELAPAPAS
КАРТОФЕЛЕЧИСТКА



GUARDA IL VIDEO
WATCH THE VIDEO

- IT** Macchina per pelare patate. Struttura in acciaio inox AISI 304 - coperchio superiore in policarbonato alimentare trasparente - microinterruttori di sicurezza su coperchio superiore e su bocca di uscita - pulsante espulsione prodotto - timer 0÷4 minuti - getto automatico d'acqua per favorire l'eliminazione dei residui di pelatura - in dotazione piattello abrasivo estraibile PTA.
- EN** Potato peeler. Structure in stainless steel AISI 304 - upper cover in clear alimentary polycarbonate - safety microswitches on the upper lid and on the inlet - product ejection button - timer 0÷4 minutes - automatic water jet to facilitate the elimination of peeling waste - extractable abrasive plate enclosed PTA.
- FR** Eplucheur de pommes de terre. Corps en acier Inox AISI 304 - couvercle supérieur en polycarbonate alimentaire transparent - micro-interrupteurs de sécurité sur le couvercle supérieur et sur l'orifice d'entrée - bouton d'éjection du produit - temporisateur 0÷4 minutes - jet d'eau automatique pour l'élimination du pelage - de série plaque abrasive extractible PTA.
- DE** Kartoffelschäler. Gehäuse aus Edelstahl AISI 304 - oberer Deckel aus durchsichtigem, lebensmitteleuglichem Polycarbonat - Sicherheitsmikroschalter am oberen Deckel und an der Einführöffnung - Produktauswurfstaste - Timer 0÷4 Minuten - automatischer Wasserstrahl zur leichteren Abreinigung - abnehmbare Schleifplatte beigefügt PTA.
- ES** Pelador de papas. Estructura de acero inoxidable AISI 304 - tapa superior de policarbonato transparente para alimentos - microinterruptores de seguridad en la tapa y la boca de salida - botón para la expulsión del producto - temporizador 0÷4 minutos - chorro de agua automático para favorecer la eliminación de los residuos de peladura - en la dotación plato abrasivo extraíble PTA.
- RU** Очиститель картофеля. Конструкция из нержавеющей стали AISI 304 - верхняя крышка из прозрачного пищевого поликарбоната - предохранительные микровыключатели на верхней крышке и на входном отверстии - кнопка выброса продукта - таймер 0÷4 минуты - автоматическая струя воды для снятия пилинга - стандартная съемная абразивная плита PTA.



OPTIONAL
CON ABRASIVO LATERALE
WITH LATERAL ABRASIVE

CI	
560 x 380 x 440(h) mm	
3,2 Kg	4,7 Kg
600 x 410 x 490(h) mm	0,121 m³

	PPN18M	PPF18M
	1,1 kW (1,5 HP)	
	230-400V/3N/50Hz	
	230V/1N/50Hz	
	± 18 Kg max	
	220 Kg/h	
	no	si / yes
	400 x 770 x 930(h) mm	380 x 770 x 1230(h) mm
	41 Kg	39 Kg
	52 Kg	50 Kg
	830 x 530 x 1050(h) mm	
	0,463 m³	

Special Voltages - Разное питающее напряжение

Con abrasivo laterale - With lateral abrasiv - С боковым абразивом

OPTIONAL



PPN25
PPF25

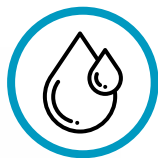

CARICO/SCARICO ACQUA
WATER INLET / OUTLET
ВХОД/ВЫХОД ВОДЫ



PPN



OPTIONAL
CASSETTO CON FILTRO
DRAWER AND FILTER

PPF25













Pelapatate





POTATO PEELER
ÉPLUCHEUSE À POMMES DE TERRE
KARTOFFELSCHÄLER
PELARAPAS
КАРТОФЕЛЕЧИСТКА



GUARDA IL VIDEO
WATCH THE VIDEO

- IT** Macchina per pelare patate. Struttura in acciaio inox AISI 304 - coperchio superiore in policarbonato alimentare trasparente - microinterruttori di sicurezza su coperchio superiore e su bocca di uscita - pulsante espulsione prodotto - timer 0÷4 minuti - getto automatico d'acqua per favorire l'eliminazione dei residui di pelatura - in dotazione piattello abrasivo estraibile PTB e abrasivo laterale di serie.
- EN** Potato peeler. Structure in stainless steel AISI 304 - upper cover in clear alimentary polycarbonate - safety microswitches on the upper lid and on the inlet - product ejection button - timer 0÷4 minutes - automatic water jet to facilitate the elimination of peeling waste - extractable PTB abrasive plate and lateral abrasive enclosed.
- FR** Eplucheur de pommes de terre. Corps en acier Inox AISI 304 - couvercle supérieur en polycarbonate alimentaire transparent - micro-interrupteurs de sécurité sur le couvercle supérieur et sur l'orifice d'entrée - bouton d'éjection du produit - temporisateur 0÷4 minutes - jet d'eau automatique pour l'élimination du pelage - de série plaque abrasive extractible PTB et côtés abrasifs.
- DE** Kartoffelschäler. Struktur aus Edelstahl AISI 304 - oberer Deckel aus durchsichtigem, lebensmitteleuglichem Polycarbonat - Sicherheitsmikroschalter am oberen Deckel und an der Einführöffnung - Produktauswurfstaste - Timer 0÷4 Minuten - automatischer Wasserstrahl zur leichteren Abreinigung - abnehmbare Schleifplatte und Schleifseiten beigelegt PTB.
- ES** Máquina para pelar patatas y zanahorias. Estructura de acero inoxidable AISI 304 - tapa superior de policarbonato transparente para alimentos - microinterruptores de seguridad en la tapa y la boca de salida - botón para la expulsión del producto - temporizador 0÷4 minutos - chorro de agua automático para favorecer la eliminación de los residuos de peladura - en la dotación plato abrasivo extraíble PTB y abrasivo lateral.
- RU** Очиститель картофеля. Конструкция из нержавеющей стали AISI 304 - верхняя крышка из прозрачного пищевого поликарбоната - предохранительные микровыключатели на верхней крышке и на входном отверстии - кнопка выброса продукта - таймер 0÷4 минуты - автоматическая струя воды для снятия пилинга - стандартная съемная абразивная плита PTB.

	PPN25	PPF25
	1,1 kW (1,5 HP)	
	230-400V/3N/50Hz	
	230V/1N/50Hz	
	± 25 Kg max	
	450 Kg/h	
	no	si / yes
	540 x 900 x 1040(h) mm	450 x 900 x 1355(h) mm
		
	61 Kg	57 Kg
	81 Kg	77 Kg
	1105 x 600 x 1123(h) mm	
	0,775 m³	

	CB 670 x 450 x 410(h) mm	
	6,5 Kg	 8 Kg
	680 x 450 x 500(h) mm	 0,153 m³

Special Voltages - Разное питающее напряжение

OPTIONAL



LCN5
LCF5

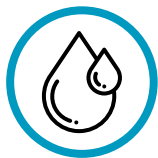

CARICO/SCARICO ACQUA
WATER INLET / OUTLET
ВХОД/ВЫХОД ВОДЫ

















LCN5







Lavacozze

MUSSEL WASHER
LAVE-MOULES
MUSCHELNWASCHMASCHINE
LAVADORAS DE MEJILLONES
МАШИНА ДЛЯ ОЧИСТКИ МИДИЙ

- IT** Macchina per pulire le cozze. Struttura in acciaio inox AISI 304 - coperchio superiore in policarbonato alimentare trasparente - microinterruttori di sicurezza su coperchio superiore e su bocca di uscita - pulsante espulsione prodotto - timer 0÷4 minuti - getto automatico d'acqua per favorire l'eliminazione dei residui di pulitura - in dotazione piattello a spazzole estraibile PPC. Il modello LCN5 è da banco.
- EN** Mussels cleaning machine. Structure in stainless steel AISI 304 - upper cover in clear alimentary polycarbonate - safety microswitches on the upper lid and on the inlet - product ejection button - timer 0÷4 minutes - automatic water jet to facilitate the elimination of peeling waste - extractable plate with brushes PPC enclosed. Table-top model LCN5.
- FR** Machine à laver les moules. Corps en acier Inox AISI 304 - couvercle supérieur en polycarbonate alimentaire transparent - micro-interrupteurs de sécurité sur le couvercle supérieur et sur l'orifice d'entrée - bouton d'éjection du produit - temporisateur 0÷4 minutes - jet d'eau automatique pour l'élimination des résidus - de série plaque extractible à brosses PPC. LCN5: modèle de table.
- DE** Maschine zum Säubern von Miesmuscheln. Gehäuse aus Edelstahl AISI 304 - oberer Deckel aus durchsichtigem, lebensmitteltauglichem Polycarbonat - Sicherheitsmikroschalter am oberen Deckel und an der Einführöffnung - Produktauswurfstaste - Timer 0÷4 Minuten - automatischer Wasserstrahl zur leichteren Abreinigung - abnehmbare PPC Platte mit Bürsten beigefügt. Tischmodell LCN5.
- ES** Máquina para lavar mejillones. Estructura de acero inoxidable AISI 304 - tapa superior de policarbonato transparente para alimentos - microinterruptores de seguridad en la tapa y la boca de salida - botón para la expulsión del producto - temporizador 0÷4 minutos - chorro de agua automático para favorecer la eliminación de los residuos de la limpieza - en la dotación plato extraíble con cepillos PPC. El modelo LCN5 es de sobremesa.
- RU** Машина для очистки мидий. Корпус из нержавеющей стали AISI 304 - верхняя крышка из прозрачного поликарбоната подходит для пищевых продуктов - безопасный микровыключатель на верхней крышке и вставном отверстии - кнопка выброса продукта - таймер 0÷4 минуты - автоматическая струя воды для облегчения очистки - съемная пластина PPC с щетками. Настольная модель LCN5.

	LCN5	LCF5
	0,26 kW (0,35 HP)	
	230-400V/3N/50Hz	
		
	230V/1N/50Hz	
	± 3/5 Kg max	
	60 Kg/h	
	no	si / yes
	520 x 630 x 590(h) mm	520 x 700 x 1010(h) mm
		
	28 Kg	27 Kg
	39 Kg	38 Kg
	830 x 530 x 740(h) mm	
	0,326 m³	

Special Voltages - Разное питающее напряжение

	CI 560 x 380 x 440(h) mm	
	3,2 Kg	 4,7 Kg
	600 x 410 x 490(h) mm	 0,121 m³

OPTIONAL



LCN10M
LCF10M



CARICO/SCARICO ACQUA
WATER INLET / OUTLET
ВХОД/ВЫХОД ВОДЫ















LCF







Lavacozze

MUSSEL WASHER
LAVE-MOULES
MUSCHELNWASCHMASCHINE
LAVADORAS DE MEJILLONES
МАШИНА ДЛЯ ОЧИСТКИ МИДИЙ

- IT** Macchina per pulire le cozze. Struttura in acciaio inox AISI 304 - coperchio superiore in policarbonato alimentare trasparente - microinterruttori di sicurezza su coperchio superiore e su bocca di uscita - pulsante espulsione prodotto - timer 0÷4 minuti - getto automatico d'acqua per favorire l'eliminazione dei residui di pulitura - in dotazione piattello a spazzole estraibile PPC.
- EN** Mussels cleaning machine. Structure in stainless steel AISI 304 - upper cover in clear alimentary polycarbonate - safety microswitches on the upper lid and on the inlet - product ejection button - timer 0÷4 minutes - automatic water jet to facilitate the elimination of peeling waste - extractable plate with brushes PPC enclosed.
- FR** Machine à laver les moules. Corps en acier Inox AISI 304 - couvercle supérieur en polycarbonate alimentaire transparent - micro-interrupteurs de sécurité sur le couvercle supérieur et sur l'orifice d'entrée - bouton d'éjection du produit - temporisateur 0÷4 minutes - jet d'eau automatique pour l'élimination des résidus - de série plaque extractible à brosses PPC.
- DE** Maschine zum Säubern von Miesmuscheln. Gehäuse aus Edelstahl AISI 304 - oberer Deckel aus durchsichtigem, lebensmitteltauglichem Polycarbonat - Sicherheitsmikroschalter am oberen Deckel und an der Einführöffnung - Produktauswurfstaste - Timer 0÷4 Minuten - automatischer Wasserstrahl zur leichteren Abreinigung - abnehmbare PPC Platte mit Bürsten beigelegt.
- ES** Máquina para lavar mejillones. Estructura de acero inoxidable AISI 304 - tapa superior de policarbonato transparente para alimentos - microinterruptores de seguridad en la tapa y la boca de salida - botón para la expulsión del producto - temporizador 0÷4 minutos - chorro de agua automático para favorecer la eliminación de los residuos de la limpieza - en la dotación plato extraíble con cepillos PPC.
- RU** Машина для очистки мидий. Корпус из нержавеющей стали AISI 304 - верхняя крышка из прозрачного поликарбоната подходит для пищевых продуктов - безопасный микровыключатель на верхней крышке и вставном отверстии - кнопка выброса продукта - таймер 0÷4 минуты - автоматическая струя воды для облегчения очистки - съемная пластина PPC с щетками.

	LCN10M	LCF10M
	0,55 kW (0,75 HP)	
 3 Ph	230-400V/3N/50Hz	
 1 Ph	230V/1N/50Hz	
	± 6/10 Kg max	
	120 Kg/h	
	no	si / yes
	400 x 770 x 860(h) mm	380 x 770 x 1160(h) mm
		
	36 Kg	34 Kg
	47 Kg	45 Kg
	830 x 530 x 1050(h) mm	830 x 530 x 740(h) mm
	0,463 m³	0,326 m³

	CI 560 x 380 x 440(h) mm			
	3,2 Kg		4,7 Kg	
	600 x 410 x 490(h) mm		0,121 m³	

Special Voltages - Разное питающее напряжение

OPTIONAL



LCN18M
LCF18M

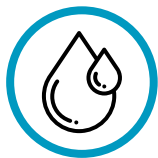

CARICO/SCARICO ACQUA
WATER INLET / OUTLET
ВХОД/ВЫХОД ВОДЫ

















LCF18M



Lavacozze

MUSSEL WASHER
LAVE-MOULES
MUSCHELNWASCHMASCHINE
LAVADORAS DE MEJILLONES
МАШИНА ДЛЯ ОЧИСТКИ МИДИЙ

- IT** Macchina per pulire le cozze. Struttura in acciaio inox AISI 304 - coperchio superiore in policarbonato alimentare trasparente - microinterruttori di sicurezza su coperchio superiore e su bocca di uscita - pulsante espulsione prodotto - timer 0÷4 minuti - getto automatico d'acqua per favorire l'eliminazione dei residui di pulitura - in dotazione piattello a spazzole estraibile PPC.
- EN** Mussels cleaning machine. Structure in stainless steel AISI 304 - upper cover in clear alimentary polycarbonate - safety microswitches on the upper lid and on the inlet - product ejection button - timer 0÷4 minutes - automatic water jet to facilitate the elimination of peeling waste - extractable plate with brushes PPC enclosed.
- FR** Machine à laver les moules. Corps en acier Inox AISI 304 - couvercle supérieur en polycarbonate alimentaire transparent - micro-interrupteurs de sécurité sur le couvercle supérieur et sur l'orifice d'entrée - bouton d'éjection du produit - temporisateur 0÷4 minutes - jet d'eau automatique pour l'élimination des résidus - de série plaque extractible à brosses PPC.
- DE** Maschine zum Säubern von Miesmuscheln. Gehäuse aus Edelstahl AISI 304 - oberer Deckel aus durchsichtigem, lebensmitteltauglichem Polycarbonat - Sicherheitsmikroschalter am oberen Deckel und an der Einführöffnung - Produktauswurfstaste - Timer 0÷4 Minuten - automatischer Wasserstrahl zur leichteren Abreinigung - abnehmbare PPC Platte mit Bürsten beigegefügt.
- ES** Máquina para lavar mejillones. Estructura de acero inoxidable AISI 304 - tapa superior de policarbonato transparente para alimentos - microinterruptores de seguridad en la tapa y la boca de salida - botón para la expulsión del producto - temporizador 0÷4 minutos - chorro de agua automático para favorecer la eliminación de los residuos de la limpieza - en la dotación plato extraíble con cepillos PPC.
- RU** Машина для очистки мидий. Корпус из нержавеющей стали AISI 304 - верхняя крышка из прозрачного поликарбоната подходит для пищевых продуктов - безопасный микровыключатель на верхней крышке и вставном отверстии - кнопка выброса продукта - таймер 0÷4 минуты - автоматическая струя воды для облегчения очистки - съемная пластина PPC с щетками.

	LCN18M	LCF18M
	0,9 kW (1,2 HP)	
	230-400V/3N/50Hz	
		
	230V/1N/50Hz	
	± 10/18 Kg max	
	220 Kg/h	
	no	si / yes
	400 x 770 x 930(h) mm	380 x 770 x 1230(h) mm
		
	41 Kg	39 Kg
	52 Kg	50 Kg
	830 x 530 x 1050(h) mm	
	0,463 m³	

Special Voltages - Разное питающее напряжение

	CI 560 x 380 x 440(h) mm			
	3,2 Kg		4,7 Kg	
	600 x 410 x 490(h) mm		0,121 m³	

OPTIONAL



PPF-LCF/5

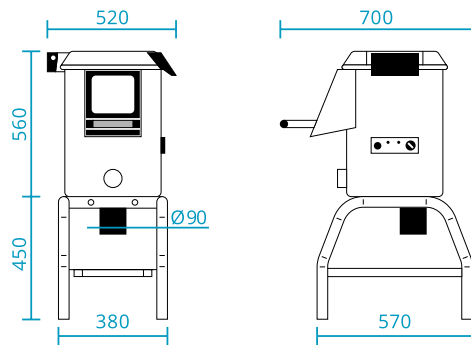

PPF-LCF/10

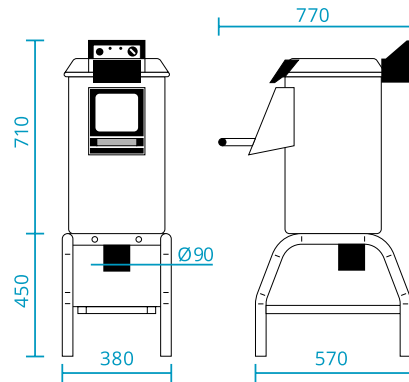

PPF-LCF/18M

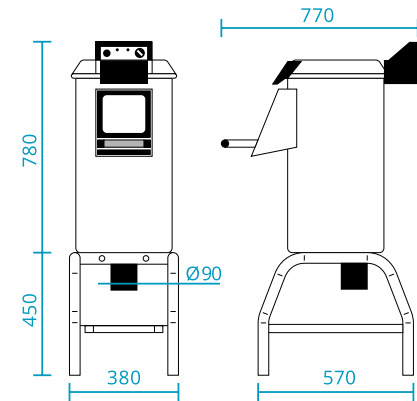

PPF/25

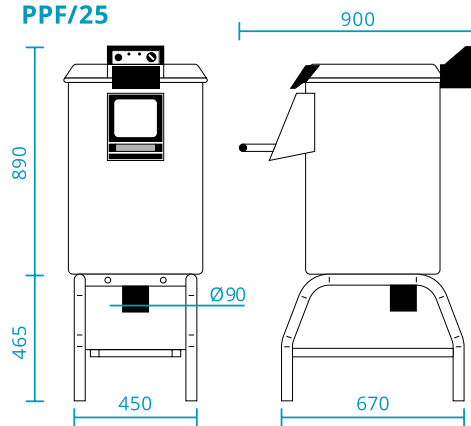

PPN-LCN/5

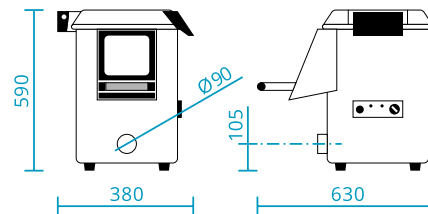

PPN-LCN/10M

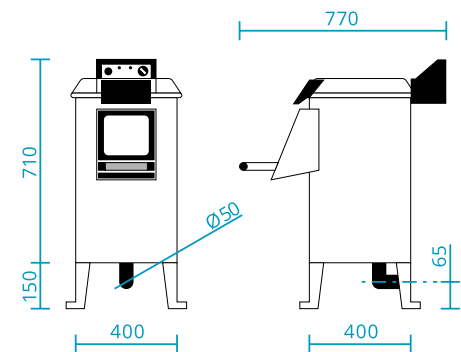

PPN-LCN/18M

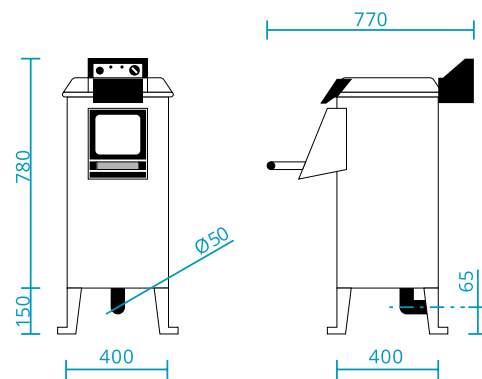

PPN/25

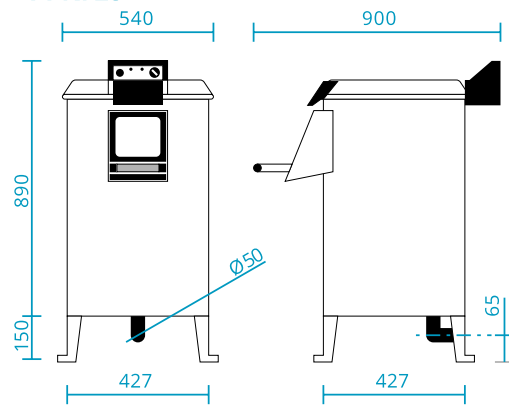

Optional

ACCESSORIES
ACCESSOIRES
ZUBEHÖR
ACCESORIOS
AKCECCYAPЫ

	ACPTA	ACPTB	ACPAB
	<p>Piattello in tela abrasiva per patate - Abrasive paper disk for potatoes Disque abrasif de papier pour pommes de terre - Schleifscheibe für Kartoffeln Plato de tela abrasiva para patatas - Абразивный диск для картофеля</p>		<p>Piattello in carborundo abrasivo per patate - Potato abrasive silica carbide plate Plaque abrasive en carbure de silice pour pomme de terre Kartoffelschleifscheibe aus Siliciumcarbid - Plato de carburo de silicio abrasivo para patatas Абразивный диск из карбида кремния для картофеля</p>
Mod.	PPN 5-10-18 PPF 5-10-18	PPN 25 PPF 25	PPN 5-10-18 PPF 5-10-18
			

	ACPPC	ACCCV	ACCCF
	<p>Piattello a spazzole per cozze - Brushing disk for mussels Plaque à brosse pour moules - Scheibe mit Bürste für Miesmuscheln - Plato con cepillos para mejillones Абразивный диск для мидий</p>	<p>Cestello lavaggio verdure - Vegetable washing basket Panier de lavage des légumes - Gemüsewaschkorb Cesta para lavar verduras Овощная корзина для мытья овощей</p>	<p>Cassetto con filtro - Drawer with filter Tiroir avec filtre - Schublade mit Sieb Cajón con filtro - Коробка с фильтром</p>
Mod.	LCN 5-10-18 LCF 5-10-18	PPN 10-18 PPF 10-18	PPF 5-10-18-25 LCF 5-10-18
			

LAV

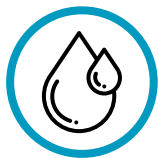

CARICO/SCARICO ACQUA
WATER INLET / OUTLET
ВХОД/ВЫХОД ВОДЫ



VEGETABLE WASHER AND DRYER
LAVEUS À LÉGUMES ET ESSOREUSES
GEMÜSEWASCH-UND TROCKNERMASCHINE
LAVADORA DE VERDURAS Y CENTRIFUGADORA
ПРИБОР ДЛЯ МОЙКИ ОВОЩЕЙ
И СУШКИ ЛИСТЬЕВ САЛАТА

Lavaverdure centrifuga



GUARDA IL VIDEO
WATCH THE VIDEO

IT Struttura in acciaio inox AISI 304 - coperchio superiore in policarbonato alimentare trasparente - microinterruttore di sicurezza su coperchio - filtro a cassetto e filtro su scarico vasca removibili - pompa di scarico ispezionabile dall'esterno - consumo acqua per ciclo 30/35 L circa - motore trifase a 2 velocità, una per il lavaggio e una per la centrifuga - possibilità di scelta di due cicli di lavaggio e tre tempi di durata per ogni ciclo - tasto "dry" per centrifuga manuale. Misure per il collegamento idrico richiesto 3/4".











EN Stainless steel AISI 304 casing - upper lid in clear alimentary polycarbonate - safety microswitch on the lid - removable drawer filter and filter on bowl drain - externally inspectable draining pump - water consumption per cycle approx. 30/35 L - three-phase motor with 2 speeds, one for washing and one for the centrifuge - possibility of choosing two. washing cycles and three duration times for each cycle - "dry" button for manual centrifuge. Measures for the required water connection 3/4".

FR Corps en acier inox AISI 304 - couvercle supérieur en polycarbonate alimentaire transparent - micro-interrupteur de sécurité sur le couvercle - filtre à tiroir amovible et filtre sur le vidange cuve - pompe d'évacuation à inspection externe - consommation en eau par cycle 30/35 L environ - moteur à trois phases avec 2 vitesses, une pour le lavage et une pour le centrifuge - possibilité de choisir deux cycles et trois temps de lavage par cycle - bouton "dry" pour centrifuger en mode manuel. Mesures pour le raccordement d'eau nécessaire 3/4".

DE Gehäuse aus Edelstahl AISI 304 - Oberdeckel aus durchsichtigem lebensmitteltauglichem Polycarbonat - Sicherheitsmikroschalter am Deckel - herausnehmbarer Schubladensieb und Filter am Schüsselablauf - extern prüfbare Entleerungspumpe - Wasserverbrauch pro Zyklus ca. 30/35 L - Dreiphasenmotor mit 2 Geschwindigkeiten, eine für das Waschen und eine für die Zentrifuge - zwei Waschzyklen und drei Durchlaufzeitzeiten pro Zyklus möglich - Taste "dry" für manuelle Zentrifuge. Maße für den erforderlichen Wasseranschluss 3/4".

ES Estructura de acero inoxidable AISI 304 - tapa superior de policarbonato transparente para alimentos - microinterruptor de seguridad en la tapa - filtro con caja y filtro en la descarga bol extraíbles - bomba de descarga para controlar del exterior - consumo de agua por ciclo 30/35 L aproximadamente - motor trifásico de dos velocidades para lavar y para centrifugar - posibilidad de elegir entre dos ciclos de lavado y tres tiempos diferentes de duración por cada ciclo - botón "dry" para centrifugación manual. Medidas para la conexión hídrica 3/4".

RU Корпус из нержавеющей стали AISI 304 - верхняя крышка из прозрачного пищевого поликарбоната - безопасный микровыключатель на крышке - съемный выдвижной фильтр и фильтр на сливном отверстии - внешний инспектируемый дренажный насос - расход воды за цикл примерно 30/35 лт - трехфазный двигатель с 2 скоростями, один для мытья и один для центрифуги - возможность выбора двух циклов мытья вручную и трех раз в течение цикла "сухой". Мероприятия по подключению необходимого количества воды 3/4".

LAV			
	0,37 - 0,11 kW (0,5-0,15 HP)		
	400V/3N/50Hz		
	<table border="1"> <tr> <td>4 Kg verdure pesanti - heavy vegetables légumes compacts - schwere Gemüse verdura con peso - тяжелые овощи</td> <td>1,5 Kg verdure in foglia - leaf vegetables légumes en feuille - Blattgemüse verdura en hojas - листовые овощи</td> </tr> </table>	4 Kg verdure pesanti - heavy vegetables légumes compacts - schwere Gemüse verdura con peso - тяжелые овощи	1,5 Kg verdure in foglia - leaf vegetables légumes en feuille - Blattgemüse verdura en hojas - листовые овощи
4 Kg verdure pesanti - heavy vegetables légumes compacts - schwere Gemüse verdura con peso - тяжелые овощи	1,5 Kg verdure in foglia - leaf vegetables légumes en feuille - Blattgemüse verdura en hojas - листовые овощи		
	3,5/4,5'		
	± 20/25 Kg/h		
	450 rpm Centrifuga (solo per verdure pesanti) Centrifuge (only for heavy vegetables) - Центрифуга (тяжелые овощи)		
	ø 280 x 270(h) mm		
	450 x 610 x 880(h) mm		
			
	40 Kg		
	50 Kg		
	850 x 550x 1070(h) mm		
	0,500 m³		

Special Voltages - Разное питающее напряжение

VV300
VV350



VV300N



VV350

Affettatrici a volano

FLYWHEEL MANUAL SLICER
TRANCHEUSES MANUELLES A VOLANT
SCHWUNGRADAUFSCNITTMASCHINE
CORTADORAS CON VOLANTE
СЛАЙСЕРЫ С ПРИВОДОМ ОТ МАХОВИКА

- IT** Macchina manuale per affettare salumi. Struttura verniciata a fuoco di colore rosso o nero - anello fisso protezione lama - regolazione spessore taglio e avanzamento automatico del carrello - spessore taglio da 0 a 25 mm.
Accessori: piedistallo in ghisa verniciato di colore rosso o nero.
- EN** Hand-operated machine for slicing cold cuts. Red or black painted surface - blade protection fixed ring - cutting thickness adjustment and automatic feeder advancement. Cutting thickness from 0 to 25 mm.
Accessories: Cast iron base, painted in red or black.
- FR** Machine manuelle pour trancher la charcuterie. Peint en rouge ou noir - anneau fixe de protection de la lame - réglage de l'épaisseur de coupe et avancement automatique de l'alimentateur. Epaisseur de coupe de 0 à 25 mm.
Accessoires: Base en fonte peinte en rouge ou en noir.
- DE** Manuelle Maschine zum Schneiden von Aufschnitt. Rot oder schwarz ofenlackierte Oberfläche - fester Schutzring für die Klingen
Schnittdickeneinstellung und automatisches Wagenvorschub. Schnittdicken von 0 bis 25 mm.
Zubehör: Standfuß aus Gusseisen, rot oder schwarz lackiert.
- ES** Máquina manual para cortar en lonchas embutidos, quesos, etc. Estructura pintada a fuego de color rojo o negro - anillo fijo para proteger la cuchilla - regulación espesor del corte y avance automático del carro. Espesor del corte de 0 a 25 mm.
Accesorios: Plataforma de hierro fundido pintado de color rojo o negro.
- RU** Ручная машина для резки холодной нарезки. Поверхность окрашена в красный или черный цвет - фиксированное защитное кольцо для лезвий, регулировка толщины резания и автоматическая подача каретки. Толщина резания от 0 до 25 мм.
Аксессуары: чугунная основа, окрашена в красный или черный цвет.



	VV300	VV350
	ø 300 mm	ø 350 mm
	260 x 190(h) mm	320 x 245(h) mm
	440 x 360 mm	660 x 550 mm
	720 x 600 x 500(h) mm	830 x 720 x 640(h) mm
	42 Kg	91 Kg
	75 Kg	123 Kg
	840 x 750 x 850(h) mm	1000 x 900 x 980(h) mm
	0,536 m ³	0,882 m ³

	CAVVV300	CAVVV350
	Cavalletto - Base - Support Gestell - Caballete - Подставка	
	560 x 380 x 800(h) mm	730 x 600 x 800(h) mm
	71 Kg	74 Kg
	87 Kg	106 Kg
	1000 x 900 x 980(h) mm	
	0,882 m ³	

ECO220
ECO250
ECO300



ECO220



ECO250



ECO300

Affettatrici serie ECO

ECO LINE SLICERS
TRANCHEUSES LIGNE ECO
AUFSCHNITTMASCHINEN SERIE ECO
CORTADORAS LÍNEA ECO
СЛАЙСЕРЫ ЛИНИИ "ECO"

IT Macchina per affettare salumi, formaggi, carni ecc. Struttura in lega leggera di alluminio verniciato - blocco piatto vela con sistema "Easy Clean" per una facile pulizia - anello fisso protezione lama - spessore taglio fino a 14÷16 mm - affilatoio fisso con coppia di smerigli per l'affilatura della lama per i modelli ECO250 - ECO300 - affilatoio amovibile incluso (inserito nel vano inferiore della macchina) per il modello ECO220.

EN Slicing machine for cold cuts, cheeses, meats, etc. Light painted aluminum alloy casing - tray block with "Easy Clean" system for an easier cleaning - blade protection fixed ring - cutting thickness up to 14÷16 mm - fixed sharpener with a pair of grinders to sharpen the blade for ECO250 - ECO300 models - Removable sharpener included (inserted in the lower compartment of the machine) for the ECO220 model.

FR Machine à trancher pour charcuterie, fromages, viandes, etc. Corps en alliage d'aluminium verni léger - bloc plateau avec système "Easy Clean" pour un nettoyage facile - anneau fixe pour la protection de la lame - épaisseur de coupe jusqu'à 14÷16 mm - affûteur fixe avec une paire de meuleuses pour affûter la lame - sur les modèles ECO250 et ECO300 - affûteur amovible inclus (inséré dans le compartiment inférieur de la machine) pour le modèle ECO220.

DE Schneidemaschine für Wurst, Käse, Fleisch, usw.. Leichtes Gehäuse aus lackierter Aluminiumlegierung - Schlittenhalterung mit "Easy Clean"-System für einfache Reinigung - fester Ring für den Klingenschutz - Schnittdicke bis 14÷16 mm - feste Schleifvorrichtung mit einem Paar Schleifer zum Schärfen der Klinge für die Modelle ECO250 - ECO300 - abnehmbare Schleifvorrichtung im Lieferumfang enthalten (im unteren Fach der Maschine eingesetzt) für das Modell ECO220.

ES Máquina para cortar en lonchas embutidos, quesos, carnes, etc. Estructura ligera de aleación de aluminio pintado - bloque plano con sistema "Easy Clean" para una fácil limpieza - anillo fijo para proteger la cuchilla - espesor del corte de 14÷16 mm - afilador fijo piedras de amolar para afilar la cuchilla para los modelos ECO250 - ECO300 - afilador extraíble incluido (insertado en el compartimento inferior de la máquina) para el modelo ECO220.

RU Режущая машина для колбас, сыра, мяса и т.д... Легкий корпус из окрашенного алюминиевого сплава - Держатель ползунков с системой "Easy Clean" для облегчения очистки - Фиксированное кольцо для защиты полотна - Толщина резания от 14÷16 мм - Фиксированное шлифовальное устройство с парой шлифмашин для заточки полотна для моделей ECO250 - ECO300 - Съёмная заточка (вставлена в нижнюю часть станка) для модели ECO220 входит в комплект поставки.



ECO250RED

	ECO220	ECO250	ECO300
	0,14 kW (0,19 HP)		0,18 kW (0,25 HP)
	230V/1N/50Hz		
	220 mm	250 mm	300 mm
	210 x 145(h) mm	220 x 160(h) mm	200 x 205(h) mm
	400 x 250 mm		
	530 x 480 x 320(h) mm	530 x 480 x 375(h) mm	550 x 480 x 430(h) mm
	12,5 Kg	14 Kg	17 Kg
	14 Kg	15 Kg	19 Kg
	480 x 545 x 410(h) mm		510 x 620 x 470(h) mm
	0,107 m ³		0,148 m ³

Special Voltages - Разное питающее напряжение

SOLO PER MODELLO ECO250 / ONLY MOD. ECO250

Su richiesta in colore rosso allo stesso prezzo.

Available on request in red color at the same price.

Sur demande en couleur rouge au même prix.

Auf Anfrage in roter Farbe erhältlich gleichen Preis.

Disponibile bajo pedido en color rojo al mismo precio.

По запросу возможна поставка в красном цвете по запросу той же цене.

ECO300L
ECO330















ECO300L



Affettatrici serie ECO

ECO LINE SLICERS
TRANCHEUSES LIGNE ECO
AUFSCHNITTMASCHINEN SERIE ECO
CORTADORAS LÍNEA ECO
СЛАЙСЕРЫ ЛИНИИ "ECO"

- IT** Macchina per affettare salumi, formaggi, carni ecc. Struttura in lega leggera di alluminio verniciato - blocco piatto vela con sistema "Easy Clean" per una facile pulizia - anello fisso protezione lama - spessore taglio fino a 14÷16 mm - affilatoio fisso con coppia di smerigli per l'affilatura della lama.
- EN** Slicing machine for cold cuts, cheeses, meats, etc. Light painted aluminum alloy casing - tray block with "Easy Clean" system for an easier cleaning - blade protection fixed ring - cutting thickness up to 14÷16 mm - fixed sharpener with a pair of grinders to sharpen the blade.
- FR** Machine à trancher pour charcuterie, fromages, viandes, etc. Corps en alliage d'aluminium anodisé léger - bloc plateau - anneau fixe pour la protection de la lame - épaisseur de coupe de 14 à 16 mm - protège-lame extractible - bouton de réglage de la lame avec échelle graduée - affûteur fixe avec une paire de meuleuses pour affûter la lame.
- DE** Schneidemaschine für Wurst, Käse, Fleisch, usw. Leichtes Gehäuse aus eloxierter Aluminiumlegierung - Schlittenhalterung - fester Ring für den Klingenschutz - Schnittdicke von 14 bis 16 mm - abnehmbarer Klingenschutz - Klingeneinstellknopf mit abgestufter Skala - feste Schleifvorrichtung mit einem Paar Schleifer zum Schärfen der Klinge.
- ES** Máquina para cortar en lonchas embutidos, quesos, carnes, etc. Estructura ligera de aleación de aluminio anodizado - bloque plano - protección vertical - espesor del corte de 14÷16 mm - anillo fijo para proteger la cuchilla y protección de la cuchilla extraíble - pomo de regulación protección vertical con escala graduada - afilador fijo piedras de amolar para afilar la cuchilla.
- RU** Режущая машина для колбас, сыра, мяса и т.д. Легкий корпус из анодированного алюминиевого сплава - Держатель ползунков - Фиксированное кольцо для защиты полотна - Толщина резания от 14 до 16 мм - Съёмная защита полотна - Регулятор регулировки полотна с градуированной шкалой - Фиксированное шлифовальное устройство с парой шлифмашин для заточки полотна.

	ECO300L	ECO330
	0,18 kW (0,25 HP)	
 1 Ph	230V/1N/50Hz	
 mm	300 mm	330 mm
 mm	245 x 195(h) mm	230 x 210(h) mm
 mm	440 x 290 mm	
 mm	605 x 480 x 460(h) mm	630 x 525 x 480(h) mm
		
 Kg	24 Kg	27 Kg
 Kg	26 Kg	30 Kg
 mm	530 x 630 x 480(h) mm	570 x 740 x 515(h) mm
 m ³	0,16 m ³	0,22 m ³

Special Voltages - Разное питающее напряжение

G220-G250-G275
G300-G350



G275



G300

New



G350

Affettatrici Serie G

G-LINE SLICERS
TRANCHEUSES LIGNE-G
AUFSCHNITTMASCHINEN SERIE-G
CORTADORAS LÍNEA-G
СЛАЙСЕРЫ ЛИНИИ "G"

IT Macchina per affettare salumi, formaggi, carni ecc. Struttura in lega leggera di alluminio anodizzato - blocco piatto vela (tranne per mod. G275 con piatto fisso) - spessore taglio da 0÷15 mm - anello fisso protezione lama - paralama estraibile - pomello regolazione vela con scala graduata - affilatoio fisso con coppia di smerigli per l'affilatura della lama.

EN Slicing machine for cold cuts, cheeses, meats, etc. Light anodized aluminum alloy casing - tray block (except for mod. G275 with fixed plate) - blade protection fixed) - cutting thickness from 0 to 15 mm - extractable blade guard - blade adjustment knob with graduated scale - fixed sharpener with a pair of grinders to sharpen the blade.

FR Machine à trancher pour charcuterie, fromages, viandes, etc. Corps en alliage d'aluminium anodisé léger - bloc plateau (sauf pour mod. G275 avec plateau fixe) - anneau fixe pour la protection de la lame - épaisseur de coupe de 0 à 15 mm - protège-lame extractible - bouton de réglage de la lame avec échelle graduée - affûteur fixe avec une paire de meuleuses pour affûter la lame.

DE Schneidemaschine für Wurst, Käse, Fleisch, usw. Leichtes Gehäuse aus eloxierter Aluminiumlegierung - Schlittenhalterung (außer für mod. G275 mit fester Platte) - fester Ring für den Klingenschutz - Schnittdicke von 0 bis 15 mm - abnehmbarer Klingenschutz - Klingeneinstellknopf mit abgestufter Skala - feste Schleifvorrichtung mit einem Paar Schleifer zum Schärfen der Klinge.

ES Máquina para cortar en lonchas embutidos, quesos, carnes, etc. Estructura ligera de aleación de aluminio anodizado - bloque plano (excepto para mod. G275 con placa fija) - protección vertical - espesor del corte de 0÷15 mm - anillo fijo para proteger la cuchilla y protección de la cuchilla extraíble - pomo de regulación protección vertical con escala graduada - afilador fijo piedras de amolar para afilar la cuchilla.

RU Режущая машина для колбас, сыра, мяса и т.д. Корпус из легкого анодированного алюминиевого сплава - держатель скольжения (за исключением mod. G275 с фиксированной пластиной) - фиксированное кольцо для защиты ножей - толщина реза от 0 до 15 мм - съемная защита ножей - ручка регулировки ножей с градуированной шкалой - фиксированное шлифовальное устройство с парой шлифмашин для заточки ножей.

	G220	G250	G275	G300	G350
	0,14 kW (0,19 HP)		0,15 kW (0,2 HP)	0,18 kW (0,25 HP)	0,3 kW (0,4 HP)
	230V/1N/50Hz				
	220 mm	250 mm	275 mm	300 mm	350 mm
	200 x 125(h) mm	195 x 145(h) mm	225 x 180(h) mm	245 x 195(h) mm	280 x 220(h) mm
	400 x 250 mm				
	425 x 400 x 355(h) mm	475 x 410 x 365(h) mm	555 x 465 x 405(h) mm	570 x 480 x 420(h) mm	685 x 555 x 515(h) mm
					
	15 Kg	15,5 Kg	16 Kg	24 Kg	35 Kg
	17 Kg	17,5 Kg	18 Kg	26 Kg	37 Kg
	530 x 480 x 390(h) mm		630 x 530 x 480(h) mm		740 x 570 x 515(h) mm
	0,100 m ³		0,160 m ³		0,220 m ³

Special Voltages - Разное питающее напряжение

HR250
HR300N
HL300



HR300N



HL300

Affettatrici a gravità
compatte e con corsa lunga

GRAVITY SLICERS
TRANCHEUSES A GRAVITE
SCHRÄGE AUFSCHNITTMASCHINEN
CORTADORAS POR GRAVEDAD
ГРАВИТАЦИОННЫЕ СЛАЙСЕРЫ

IT Macchina per affettare salumi, formaggi, carni ecc. Struttura in lega leggera di alluminio anodizzato - blocco piatto vela - modelli compatti - spessore taglio da 0÷15 mm - anello fisso protezione lama - paralama estraibile - pomello regolazione vela con scala graduata - affilatoio fisso con coppia di smerigli per l'affilatura della lama.













EN Slicing machine for cold cuts, cheeses, meats, etc. Light anodized aluminum alloy casing - tray block - compact models - blade protection fixed ring - cutting thickness from 0 to 15 mm - extractable blade guard - blade adjustment knob with graduated scale - fixed sharpener with a pair of grinders to sharpen the blade.

FR Machine à trancher pour charcuterie, fromages, viandes, etc. Corps en alliage d'aluminium anodisé léger - bloc plateau - longue course - anneau fixe pour la protection de la lame - épaisseur de coupe de 0 à 15 mm - protège-lame extractible - bouton de réglage de la lame avec échelle graduée - affûteur fixe avec une paire de meuleuses pour affûter la lame.

DE Schneidemaschine für Wurst, Käse, Fleisch, usw. Leichtes Gehäuse aus eloxierter Aluminiumlegierung - Schlittenhalterung - fester Ring für den Klingenschutz - Kompaktmodelle - Schnittdicke von 0 bis 15 mm - abnehmbarer Klingenschutz - Klingeneinstellknopf mit abgestufter Skala - feste Schleifvorrichtung mit einem Paar Schleifer zum Schärfen der Klinge.

ES Máquina para cortar en lonchas embutidos, quesos, carnes, etc. Estructura ligera de aleación de aluminio anodizado - bloque plano - protección vertical - modelos compactos - espesor del corte de 0÷15 mm - anillo fijo para proteger la cuchilla y protección de la cuchilla extraíble - pomo de regulación protección vertical con escala graduada - afilador fijo piedras de amolar para afilar la cuchilla.

RU Режущая машина для колбас, сыра, мяса и т.д. Корпус из легкого анодированного алюминиевого сплава - держатель скольжения - фиксированное кольцо для защиты ножей - компактные модели - толщина реза от 0 до 15 мм - съемная защита ножей - ручка регулировки ножей с градуированной шкалой - фиксированное шлифовальное устройство с парой шлифмашин для заточки ножей.

	HR250	HR300N	HL300
	0,18 kW (0,25 HP)	0,23 kW (0,3 HP)	0,37 kW (0,5 HP)
	-		230-400V/3/50Hz
	230V/1N/50Hz		
	250 mm	300 mm	
	190 x 190(h) mm	220 x 210(h) mm	260 x 220(h) mm
	410 x 290 mm	450 x 300 mm	550 x 410 mm
	620 x 425 x 370(h) mm		770 x 540 x 460(h) mm
			
	15 Kg	20 Kg	31 Kg
	17 Kg	24 Kg	42 Kg
	540 x 460 x 450(h) mm	640 x 520 x 490(h) mm	700 x 650 x 640(h) mm
	0,112 m ³	0,163 m ³	0,291 m ³

Special Voltages - Разное питающее напряжение

H220N-H250N
H275N-H300N
H330-H350-H370















Affettatrici a gravità
con lama da 220 a 370 mm

GRAVITY SLICERS
TRANCHEUSES A GRAVITE
SCHRÄGE AUFSCHNITTMASCHINEN
CORTADORAS POR GRAVEDAD
ГРАВИТАЦИОННЫЕ СЛАЙСЕРЫ

- IT Macchina per affettare salumi, formaggi, carni ecc. Struttura in lega leggera di alluminio anodizzato - blocco piatto vela - anello fisso protezione lama - spessore taglio da 0 a 15 mm - paralama estraibile - pomello regolazione vela con scala graduata - affilatoio fisso con coppia di smerigli per l'affilatura della lama.
- FR Machine à trancher pour charcuterie, fromages, viandes, etc. Corps en alliage d'aluminium anodisé léger - bloc plateau - anneau fixe pour la protection de la lame - épaisseur de coupe de 0 à 15 mm - protège-lame extractible - bouton de réglage de la lame avec échelle graduée - affûteur fixe avec une paire de meuleuses pour affûter la lame.
- ES Máquina para cortar en lonchas embutidos, quesos, carnes, etc. Estructura ligera de aleación de aluminio anodizado - bloque plano - protección vertical - espesor del corte de 0÷15 mm - anillo fijo para proteger la cuchilla y protección de la cuchilla extraíble - pomo de regulación protección vertical con escala graduada - afilador fijo piedras de amolar para afilar la cuchilla.

- EN Slicing machine for cold cuts, cheeses, meats, etc. Light anodized aluminum alloy casing - tray block - blade protection fixed ring - cutting thickness from 0 to 15 mm - extractable blade guard - blade adjustment knob with graduated scale - fixed sharpener with a pair of grinders to sharpen the blade.
- DE Schneidemaschine für Wurst, Käse, Fleisch, usw. Leichtes Gehäuse aus eloxierter Aluminiumlegierung - Schlittenhalterung - fester Ring für den Klingenschutz - Schnittdicke von 0 bis 15 mm - abnehmbarer Klingenschutz - Klingeneinstellknopf mit abgestufter Skala - feste Schleifvorrichtung mit einem Paar Schleifer zum Schärfen der Klinge.
- RU Режущая машина для колбас, сыра, мяса и т.д. Легкий корпус из анодированного алюминиевого сплава - Держатель ползунков - Фиксированное кольцо для защиты полотна - Толщина резания от 0 до 15 мм - Съёмная защита полотна - Регулятор регулировки полотна с градуированной шкалой - Фиксированное шлифовальное устройство с парой шлифмашин для заточки полотна.



	H220N	H250N	H275N	H300N	H330	H350	H370
	0,18 kW (0,25 HP)	0,23 kW (0,3 HP)		0,26 kW (0,35 HP)	0,37 kW (0,5 HP)		
	-			230-400V/3/50Hz			
	230V/1N/50Hz						
	220 mm	250 mm	275 mm	300 mm	330 mm	350 mm	370 mm
	190 x 160(h) mm	220 x 190(h) mm	220 x 210(h) mm	220 x 220(h) mm	260 x 235(h) mm	310 x 260(h) mm	300 x 275(h) mm
	410 x 290 mm	450 x 300 mm		480 x 350 mm	550 x 410 mm	600 x 430 mm	
	580 x 405 x 340(h) mm	620 x 425 x 370(h) mm	620 x 440 x 390(h) mm	650 x 495 x 440(h) mm	770 x 550 x 465(h) mm	890 x 585 x 480(h) mm	
							
	14 Kg	17 Kg	18 Kg	24 Kg	32 Kg	36 Kg	37 Kg
	16 Kg	19 Kg	20 Kg	27 Kg	43 Kg	52 Kg	53 Kg
	490 x 470 x 400(h) mm	540 x 460 x 450(h) mm		640 x 520 x 490(h) mm	700 x 650 x 640(h) mm	800 x 730 x 670(h) mm	
	0,092 m³	0,112 m³		0,163 m³	0,291 m³	0,391 m³	

Special Voltages - Разное питающее напряжение

Affettatrici verticali con carrello removibile

VERTICAL SLICERS
TRANCHEUSES VERTICALES
VERTIKALE AUFSCHNITTMASCHINE
CORTADORAS VERTICALES
ВЕРТИКАЛЬНЫЕ СЛАЙСЕРЫ

V250-VR300N
VM300-V330
V350-V370



V350



VR300N

IT Macchina per affettare salumi, carne, formaggi, ecc. Struttura in lega leggera di alluminio anodizzato - blocco piatto vela per rimozione carrello - disponibili con piatto carne (escluso mod. V250) - spessore taglio 0÷16 mm - anello fisso protezione lama - paralama estraibile - pomello regolazione vela con scala graduata - affilatoio fisso con coppia di smerigli per l'affilatura della lama.

FR Machine à trancher pour charcuterie, fromages, viandes, etc. Corps en alliage d'aluminium anodisé léger - bloc plateau pour l'enlèvement du plateau - également disponible avec plateau à viande coulissant (modèle V250 exclu) - anneau fixe pour la protection de la lame - épaisseur de coupe de 0 à 16 mm - protège-lame extractible - bouton de réglage de la lame avec échelle graduée - affûteur fixe avec une paire de meuleuses pour affûter la lame.

ES Máquina para cortar en lonchas embutidos, quesos, carnes, etc. Estructura ligera de aleación de aluminio anodizado - bloque plano - protección vertical para quitar el carro - disponibles con plato carne (excluido modelo V250) - espesor del corte de 0÷16 mm - anillo fijo para proteger la cuchilla y protección de la cuchilla extraíble - pomo de regulación protección vertical con escala graduada - afilador fijo piedras de amolar para afilar la cuchilla.

EN Slicing machine for cold cuts, cheeses, meats, etc. Light anodized aluminum alloy casing - tray block for table removing - also available with sliding meat table (model V250 excluded) - blade protection fixed ring - cutting thickness from 0 to 16 mm - extractable blade guard - blade adjustment knob with graduated scale - fixed sharpener with a pair of grinders to sharpen the blade.

DE Schneidemaschine für Wurst, Käse, Fleisch, usw...Leichtes Gehäuse aus eloxierter Aluminiumlegierung - Schlittenhalterung für sichere Entnahme- fester Ring für den Klingenschutz - auch mit Fleischschlitten erhältlich (außer Modell V250) - Schnittdicke von 0 bis 16 mm - abnehmbarer Klingenschutz - Klingeneinstellknopf mit abgestufter Skala - feste Schleifvorrichtung mit einem Paar Schleifer zum Schärfen der Klinge.

RU Режущая машина для колбас, сыра, мяса и т.д...Корпус из легкого анодированного алюминиевого сплава - держатель скольжения - фиксированное кольцо для защиты ножей - также предлагается с раздвижным мясным столом (исключая модель V250) - толщина реза от 0 до 16 мм - съемная защита ножей - ручка регулировки ножей с градуированной шкалой - фиксированное шлифовальное устройство с парой шлифмашин для заточки ножей.















V370

**ESCLUSO MOD. V250 / MODEL V250 EXCLUDED
ИСКЛЮЧАЯ МОДЕЛЬ V250**

Disponibili con piatto carne allo stesso prezzo.
Available with meat table at the same price.
Disponibile avec plateau à viande au même prix.
Erhältlich mit Fleischschlitten zum gleichen Preis.
Disponibles con plato para carne al mismo precio.
Доступны с лотком для мяса той же цене.



	V250	VR300N	VM300	V330	V350	V370
	0,26 kW (0,35 HP)			0,37 kW (0,5 HP)		
	-	230-400V/3/50Hz				
	230V/1N/50Hz					
	250 mm	300 mm		330 mm	350 mm	370 mm
	240 x 170(h) mm	240 x 195(h) mm	260 x 190(h) mm	300 x 230(h) mm	310 x 240(h) mm	330 x 260(h) mm
	470 x 370 mm		495 x 360 mm	575 x 435 mm		
	530 x 430 x 500(h) mm	610 x 520 x 520(h) mm	650 x 500 x 460(h) mm	790 x 650 x 560(h) mm	790 x 650 x 570(h) mm	790 x 650 x 580(h) mm
						
	24 Kg	27,6 Kg	35 Kg	43 Kg	44 Kg	45 Kg
	34 Kg	40 Kg	43 Kg	53 Kg	54 Kg	55 Kg
	700 x 630 x 630(h) mm	700 x 630 x 700(h) mm	550 x 670 x 550(h) mm	650 x 800 x 610(h) mm		
	0,278 m³	0,309 m³	0,203 m³	0,317 m³		

Special Voltages - Разное питающее напряжение

K300-K330
K350-K370



K330















K350

Affettatrici verticali con carrello fisso

VERTICAL SLICERS
TRANCHEUSES VERTICALES
VERTIKALE AUFSCHNITTMASCHINE
CORTADORAS VERTICALES
ВЕРТИКАЛЬНЫЕ СЛАЙСЕРЫ

- IT** Macchina per affettare salumi, carne, formaggi ecc. Struttura in lega leggera di alluminio anodizzato - carrello fisso - disponibili con piatto carne - anello fisso protezione lama - spessore taglio 0÷15 mm - paralama estraibile - pomello regolazione vela con scala graduata - affilatoio fisso con coppia di smerigli per l'affilatura della lama.
- EN** Slicing machine for cold cuts, cheeses, meats, etc. Light anodized aluminum alloy casing - also available with sliding meat table - blade protection fixed ring - cutting thickness from 0 to 15 mm - extractable blade guard - blade adjustment knob with graduated scale - fixed sharpener with a pair of grinders to sharpen the blade.
- FR** Machine à trancher pour charcuterie, fromages, viandes, etc. Corps en alliage d'aluminium anodisé léger - également disponible avec plateau à viande coulissant - anneau fixe pour la protection de la lame - épaisseur de coupe de 0 à 15 mm - protège-lame extractible - bouton de réglage de la lame avec échelle graduée - affûteur fixe avec une paire de meuleuses pour affûter la lame.
- DE** Käse, Fleisch, usw. Leichtes Gehäuse aus eloxierter Aluminiumlegierung - Schlittenhalterung für sichere Entnahmefester Ring für den Klingenschutz - auch mit Fleischschlitten erhältlich - Schnittdicke von 0 bis 15 mm - abnehmbarer Klingenschutz - Klingeneinstellknopf mit abgestufter Skala - feste Schleifvorrichtung mit einem Paar Schleifer zum Schärfen der Klinge.
- ES** Máquina para cortar en lonchas embutidos, quesos, carnes, etc. Estructura ligera de aleación de aluminio anodizado - protección vertical - plato fijo para proteger la cuchilla y protección de la cuchilla extraíble - pomo de regulación protección vertical con escala graduada - afilador fijo piedras de amolar para afilar la cuchilla.
- RU** Режущая машина для колбас, сыра, мяса и т.д... Корпус из легкого анодированного алюминиевого сплава - фиксированное кольцо для защиты ножей - также предлагается с раздвижным мясным столом - толщина реза от 0 до 15 мм - съемная защита ножей - ручка регулировки ножей с градуированной шкалой - фиксированное шлифовальное устройство с парой шлифмашин для заточки ножей.



	K300	K330	K350	K370
	0,37 kW (0,5 HP)			
	230-400V/3/50Hz			
	230V/1N/50Hz			
	300 mm	330 mm	350 mm	370 mm
	260 x 200(h) mm	250 x 210(h) mm	300 x 265(h) mm	290 x 275(h) mm
	570 x 470 mm		660 x 540 mm	
	710 x 550 x 610(h) mm		820 x 650 x 640(h) mm	
				
	35 Kg	36 Kg	43 Kg	46 Kg
	47 Kg	48 Kg	55 Kg	58 Kg
	700 x 620 x 700(h) mm		820 x 720 x 760(h) mm	
	0,304 m³		0,449 m³	

Special Voltages - Разное питающее напряжение

Disponibili con piatto carne allo stesso prezzo.
 Available with meat table at the same price.
 Disponible avec plateau à viande au même prix.
 Erhältlich mit Fleischschlitten zum gleichen Preis.
 Disponibles con plato para carne al mismo precio.
 Доступны с лотком для мяса той же цене.

ALP3000



Asciuga lucida posate

CUTLERY DRYER-POLISHER
MACHINES À ESSUYER
ET POLIR LES COUVERTS
BESTECKTROCKNER-/POLIERER
SECADORAS ABRILLANTADORAS DE CUBIERTOS
СУШИЛЬНО-ПОЛИРОВОЧНАЯ МАШИНА ДЛЯ
СТОЛОВЫХ ПРИБОРОВ

IT Macchina per asciugare e lucidare le posate appena uscite dalla lavastoviglie rendendole asciutte e brillanti senza macchie di calcare grazie alla sinergia della vibrazione della vasca interna e allo sfregamento della polvere di tutolo di mais (prodotto completamente vegetale, atossico, trattato con particolari agenti antibatterici). Realizzata in acciaio inox AISI 304 - dotata di una lampada UV che diminuisce la carica batterica presente nelle posate anche dopo il lavaggio - vasca interna rivestita con resina resistente agli urti e certificata ad uso alimentare - capacità di 50 posate al minuto.

EN Cutlery dryer-polisher is created to quickly dry and polish wet cutlery straight out of the dishwasher. Thanks to the synergy of the internal bowl vibrations and to the friction of the corncob powder (completely vegetable product, non-toxic, treated with special antibacterial agents), the cutlery comes out perfectly dry and shiny, with no limescale spots, thus avoiding lengthy polishing by hand. Made of stainless steel AISI 304 - equipped with a UV lamp that reduces the bacterial load in the cutlery even after washing - internal bowl coated with impact-resistant resin certified for food use - capacity of 50 pieces per minute.

FR La machine à essuyer et polir les couverts est conçue pour sécher et polir rapidement les couverts mouillés qui sortent directement du lave-vaisselle. Grâce à la synergie des vibrations internes de la cuve et au frottement de la poudre de rafles de maïs (produit entièrement végétal, non toxique, traité avec des agents antibactériens spéciaux), les couverts ressortent parfaitement secs et brillants, sans trace de calcaire, ce qui évite un long polissage à la main. Fabriqué en acier inox AISI 304 - équipé d'une lampe UV qui réduit la charge bactérienne dans la coutellerie même après le lavage - cuve interne recouverte d'une résine résistante aux chocs et certifiée pour un usage alimentaire - capacité de 50 pièces par minute.

DE Der Besteckrockner-Polierer dient zum schnellen Trocknen und Polieren von nassem Besteck direkt aus der Geschirrspülmaschine. Dank der Synergie der inneren Schüsselschwingungen und der Reibung des Maiskolbenpulvers (rein pflanzliches Produkt, ungiftig, mit speziellen antibakteriellen Mitteln behandelt) entsteht ein perfekt trockenes und glänzendes Besteck ohne Kalkflecken, wodurch langes Polieren von Hand vermieden wird. Aus Edelstahl AISI 304 - ausgestattet mit einer UV-Lampe, die die Bakterienbelastung im Besteck auch nach dem Waschen reduziert - Innenschüssel mit schlagfestem, lebensmitteltauglichem Harz beschichtet - Leistung 50 Stück pro Minute.

ES Máquina realizada para secar y abrillantar rápidamente cubiertos mojados, recién salidos de la lavavajillas. Gracias a la sinergia de la vibración del bol interior y al roce del granulado de mazorca maíz (producto enteramente vegetal, anti-tóxico, tratado con agentes antibacterianos), los cubiertos salen en menos de un minuto perfectamente secos y brillantes, sin manchas de cal, evitando el largo abrillantado manual. De acero inoxidable AISI 304 - dotada de lámpara UV que disminuye drásticamente la carga bacteriana presente en los cubiertos incluso después del lavado - el bol interior está revestido con una resina especial, resistente a los golpes y certificada para uso alimentario. Capacidad 50 cubiertos al minuto.

RU Столовая сушилка-полировальная машина предназначена для быстрого высыхания и полирования столовых приборов прямо из посудомоечной машины. Благодаря синергии внутренних колебаний чаши и трения порошка коронки (полностью нетоксичный, нетоксичный, обработанный специальными антибактериальными средствами продукт) столовые приборы получают совершенно сухими и блестящими, без пятен накипи, что позволяет избежать длительного полирования вручную. Изготовлен из нержавеющей стали AISI 304 - оснащен УФ лампой, снижающей бактериальную нагрузку на столовые приборы даже после мойки - внутренняя чаша покрыта ударопрочной смолой, сертифицированной для пищевого использования - производительность 50 штук в минуту.

ALP3000	
	0,5 kW (0,7 HP)
 1 Ph	230V/1N/50Hz
	2,5 Kg (Tutolo di mais - Corn cob - Кукурузный гранулят)
	3000 h/N.
	620 x 550 x 520(h) mm
	
	53,5 Kg
	70 Kg
	800 x 650 x 720(h) mm
	0,375 m³

Special Voltages - Разное питающее напряжение

TUTOLO	
	Tutolo di mais - Corn cob - Rafle de maïs - Maisgranulat Granulado de maíz - Кукурузный гранулят
	3,5 Kg confezione/pack

TS300
TS400



TS300







TS400

Termosigillatrici semi-automatiche

SEMI-AUTOMATIC
THERMOSEALING MACHINE
THERMOSCELLEUSE SEMI-AUTOMATIQUE
HALBAUTOMATISCHE
THERMOVERSIEGELUNGSMASCHINE
TERMOSELLADORA SEMIAUTOMÁTICA
ПОЛУАВТОМАТИЧЕСКАЯ
ТЕРМОУПАКОВОЧНАЯ МАШИНА

- IT** Termosigillatrice semi-automatica per il confezionamento di prodotti in vaschetta. Possibilità di sigillare in maniera igienica i prodotti in vaschetta al fine di migliorarne la conservazione - ciclo di lavoro manuale - comandi digitali - stampi non inclusi.
- EN** Semi-automatic thermosealing machine for the packaging of products in trays. Allows to hygienically seal products in trays in order to improve their preservation - manual working cycle - digital controls - moulds not included.
- FR** Thermoscelleuse semi-automatique pour l'emballage de produits en bacs. Permet de sceller hygiéniquement les produits en bacs afin d'améliorer leur conservation - cycle de travail manuel - commandes numériques - moules non inclus.
- DE** Halbautomatische Thermoversiegelungsmaschine zum Verpacken von Produkten in Schalen. Kann Produkte in Schalen hygienisch versiegeln, um ihre Haltbarkeit zu verbessern - manueller Arbeitszyklus - digitale Steuerung - Formen nicht inbegriffen.
- ES** Termoselladora semiautomática para el envasado de productos en bandejas. Posibilidad de sellar higiénicamente los productos en bandejas para mejorar su conservación - ciclo de trabajo manual - controles digitales - moldes no incluidos.
- RU** Полуавтоматическая термоупаковочная машина для упаковки продуктов в лотки. Возможность гигиенической герметизации продуктов в лотках для улучшения их сохранности - ручной рабочий цикл - цифровое управление - формы в комплект не входят.

	TS300	TS400
	0,6 kW	1,2 kW
 1 Ph	230V/1N/50-60Hz	
	200 mm	370 mm
	280 x 500 x 600(h) mm aperto / open	400 x 500 x 600(h) mm aperto / open
		
 NET Kg	16 Kg	26 Kg
 GROSS Kg	18 Kg	32 Kg
 mm	600 x 400 x 300(h) mm	610 x 520 x 490(h) mm
 m ³	0,100 m ³	0,290 m ³

Special Voltages - Разное питающее напряжение

NON INCLUSO / NOT INCLUDED

Combinazione vaschette - Container combination
Комбинированные лотки

TS300

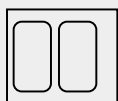

138x96 mm

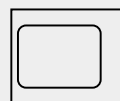

193x138 mm

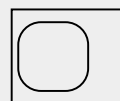

180x180 mm



195x260 mm

NON INCLUSO / NOT INCLUDED

Combinazione vaschette - Container combination
Комбинированные лотки

TS400



GN 1/2
265x320 mm

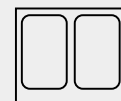

GN 1/4
265x160 mm

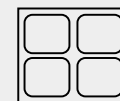

GN 1/8
160x130 mm



GN 2 x
180x180 mm

OPTIONAL



252

247

TS3A



TS3A

Termosigillatrice automatica

HEAT SEALERS
THERMOSCELLEUSES
THERMOVERSIEGELUNGSGERÄTE
SELLADORAS TÉRMICAS
ТЕРМОЗАПЕЧАТЫВАЮЩАЯ МАШИНА

IT Macchina per termo sigillare gli alimenti dentro le vaschette, permettendo così di mantenere fragranza e gusto. Costruita in acciaio inox AISI 304 - piastra saldante interna per evitare scottature - trascinamento automatico del film senza alcun ausilio manuale - controllo elettronico della temperatura di saldatura per sigillare perfettamente le vaschette - dai 6 agli 8 cicli al minuto di lavoro - non è dotata di stampo di serie, è possibile sceglierne uno tra gli optional.











EN Machine for thermo sealing of foods inside the containers allowing to maintain fragrance and taste. Made of stainless steel AISI 304 - internal sealing plate to avoid burns - automatic film dragging with no manual aid - electronic sealing temperature control to perfectly seal the containers - from 6 to 8 operating cycles per minute. Not equipped with moulds, you can choose one among our options.

FR Machine de thermoscellage des aliments à l'intérieur des bacs permettant de maintenir la fragrance et le goût. En acier Inox AISI 304 - plaque de scellage interne pour éviter les brûlures - entraînement automatique du film sans aide manuelle - contrôle électronique de la température de scellage pour sceller parfaitement les récipients - de 6 à 8 cycles par minute de travail - pas de moule en standard, vous pouvez en choisir un en option.

DE Maschine zum thermischen Verschließen von Lebensmitteln in den Behältern, die es ermöglicht, Duft und Geschmack zu erhalten. Aus Edelstahl AISI 304 - mit innenliegender Siegelplatte zur Vermeidung von Verbrennungen - automatisches Nachziehen der Folie ohne manuelle Hilfe - elektronischer Siegeltemperaturregler zum perfekten Verschließen der Behälter - von 6 bis 8 Betriebszyklen pro Minute - standardmäßig ohne Form, optional kann eine Form gewählt werden.

ES Máquina para termosellar los alimentos en bandejas, para que mantengan su fragancia y sabor. Máquinas de acero inoxidable AISI 304, con placa de sellado interior para evitar quemaduras, arrastre automático del film sin ninguna ayuda manual, control electrónico de la temperatura de soldadura para sellar perfectamente las bandejas - de 6 a 8 ciclos de trabajo al minuto - no tiene bandejas de serie, puede elegir una como opción.

RU Машина для термозапечатывания пищевых продуктов внутри емкостей, позволяющая поддерживать аромат и вкус. Изготовлен из нержавеющей стали AISI 304, с внутренней плитой для предотвращения ожогов, автоматическое перетаскивание пленки без помощи оператора, электронный контроль температуры пломбы для идеальной герметизации контейнеров - до 9 предустановленных программ - от 6 до 8 рабочих циклов в минуту - не оснащены стандартной пресс-формой, вы можете выбрать одну.

	TS3A
	1,5 kW (2 HP)
 1 Ph	230V/1N/50Hz
	380 mm - ø 200 mm - 150 mt
 mm	460 x 510 x 555(h) mm
	
 NET Kg	35 Kg
 GROSS Kg	40 Kg
 mm	470 x 510 x 570(h) mm
 m ³	0,137 m ³

Special Voltages - Разное питающее напряжение

NON INCLUSO / NOT INCLUDED

Combinazione vaschette - Container combination
Комбинированные лотки

TS3A

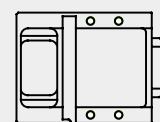

190x260 mm
190x230 mm
190x137 mm
95x137 mm

OPTIONAL



TS1A-TS2A
TS1-TS2



Termosigillatrici
automatiche e manuali

HEAT SEALERS
THERMOSCELLEUSES
THERMOVERSIEGELUNGSGERÄTE
SELLADORAS TÉRMICAS
ТЕРМОЗАПЕЧАТЫВАЮЩАЯ МАШИНА

IT Macchina per termo sigillare gli alimenti dentro le vaschette permettendo di mantenere fragranza e gusto. Costruite in acciaio inox AISI 304, con piastra saldante interna per evitare scottature, trascinamento automatico del film senza alcun ausilio manuale, controllo elettronico della temperatura di saldatura per sigillare perfettamente le vaschette - fino a 9 programmi pre-impostati - dai 6 agli 8 cicli al minuto di lavoro - dotate di stampo multiform.

TS1A-TS2A: sigillatura automatica.

TS1-TS2: sigillatura manuale tramite pressione leva.

FR Machine de thermoscellage des aliments à l'intérieur des bacs permettant de maintenir la fragrance et le goût. En acier Inox AISI 304, avec plaque de scellage interne pour éviter les brûlures, entraînement automatique du film sans aide manuelle, contrôle électronique de la température de scellage pour sceller parfaitement les récipients - jusqu'à 9 programmes prédéfinis - de 6 à 8 cycles par minute de travail - équipée de moule Multiform.

TS1A-TS2A: scellage automatique.

TS1-TS2: scellage manuel par pression du levier.

ES Máquina para termosellar los alimentos en bandejas, para que mantengan su fragancia y sabor. Máquinas de acero inoxidable AISI 304, con placa de sellado interior para evitar quemaduras, arrastre automático del film sin ninguna ayuda manual, control electrónico de la temperatura de soldadura para sellar perfectamente las bandejas -Hasta 9 programas preestablecidos - de 6 a 8 ciclos de trabajo al minuto - equipado con molde multiform.

TS1A-TS2A: sellado automático.

TS1-TS2: el sellado es manual.

EN Machine for thermo sealing of foods inside the containers allowing to maintain fragrance and taste. Made of stainless steel AISI 304, with internal sealing plate to avoid burns, automatic film dragging with no manual aid, electronic sealing temperature control to perfectly seal the containers - up to 9 pre-set programs - from 6 to 8 operating cycles per minute. Equipped with Multiform mould.

TS1A-TS2A: automatic sealing.

TS1-TS2: manual sealing by lever pressure.

DE Maschine zum thermischen Verschließen von Lebensmitteln in den Behältern, die es ermöglicht, Duft und Geschmack zu erhalten. Aus Edelstahl AISI 304, mit innenliegender Siegelplatte zur Vermeidung von Verbrennungen, automatisches Nachziehen der Folie ohne manuelle Hilfe, elektronischer Siegeltemperaturregler zum perfekten Verschließen der Behälter - bis zu 9 voreingestellte Programme - von 6 bis 8 Betriebszyklen pro Minute - ausgestattet mit Multiform-Form.

TS1A-TS2A: automatisches Verschließen

TS1-TS2: manuelles Verschließen.

RU Машина для термозапечатывания пищевых продуктов внутри емкостей, позволяющая поддерживать аромат и вкус. Изготовлен из нержавеющей стали AISI 304, с внутренней плитой для предотвращения ожогов, автоматическое перетаскивание пленки без помощи оператора, электронный контроль температуры пломбы для идеальной герметизации контейнеров - до 9 предустановленных программ - от 6 до 8 рабочих циклов в минуту - оснащены пресс-формами Multiform.

TS1A-TS2A: автоматическое пломбирование

TS1-TS2: ручное пломбирование с помощью рычага давления

INCLUSO/INCLUDED

Combinazione vaschette - Container combination
Комбинированные лотки

TS1A - TS1

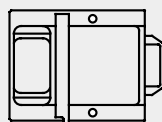

137x190 mm
137x125 mm
137x95 mm

INCLUSO/INCLUDED

Combinazione vaschette - Container combination
Комбинированные лотки

TS2A - TS2

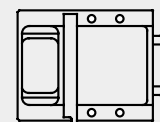

190x260 mm
190x230 mm
190x137 mm
95x137 mm











OPTIONAL



252



251

	AUTOMATICHE - AUTOMATIC		MANUALI - MANUAL	
	TS1A	TS2A	TS1	TS2
	0,55 kW (0,7 HP)	0,75 kW (1 HP)	0,55 kW (0,7 HP)	0,75 kW (1 HP)
	230V/1N/50Hz			
	150 mm - ø 160 mm - 150 mt	220 mm - ø 200 mm - 150 mt	150 mm - ø 160 mm - 150 mt	220 mm - ø 200 mm - 150 mt
	240 x 300 x 500(h) mm	315 x 450 x 550(h) mm	260 x 300 x 500(h) mm	315 x 450 x 550(h) mm
				
	20 Kg	25 Kg	20 Kg	25 Kg
	23 Kg	28 Kg	23 Kg	28 Kg
	260 x 420 x 520(h) mm	320 x 460 x 570(h) mm	260 x 420 x 520(h) mm	320 x 460 x 570(h) mm
	0,057 m³	0,084 m³	0,057 m³	0,084 m³

Special Voltages - Разное питающее напряжение

Bobine film - Film reels - Bobines de film - Folienrolle Bobina de película - бобины с пленкой			
Mod.			
TS1 - TS1A - TS300	BOB01	150 mm - 150 m	
TS2 - TS2A - TS300	BOB02	200 mm - 150 m	
TS400	BOB05	370 mm - 150 m	

BOB-01
TS1 - TS1A
TS300



150 mm
ø 160 mm
150 m

BOB-02
TS2 - TS2A
TS300

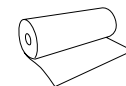

200 mm
ø 200 mm
150 m

BOB-05
TS400

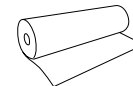

370 mm
ø 200 mm
150 m

Optional

ACCESSORIES
ACCESSOIRES
ZUBEHÖR
ACCESORIOS
AKCECCYAPЫ

Stampi personalizzabili solo con invio vaschetta campione
Customisable moulds only by sending sample tray
Moules personnalisables uniquement par l'envoi d'un bac à échantillon
Moldes personalizables sólo enviando cubeta de muestras
Individuell gestaltbare Formen nur durch Zusendung eines Musterbehälters
Изготовление форм по индивидуальному заказу только при отправке лотка с образцами

Mod.			Impronte - Impression - Empreinte Vertiefung - Sellado - Оттиск
T3SA	ACSTTSA01	Dim. Max. 370 x 280 mm	n. 1
	ACSTTSA02	Dim. Max. 180 x 280 mm	n. 2
	ACSTTSA03	Dim. Max. 180 x 135 mm	n. 4

Stampi - Moulds - Moules - Formen - Moldes - Штампы

Mod.			Impronte - Impression - Empreinte Vertiefung - Sellado - Оттиск
TS1-TS1A	ACSTTSA07	137 x 190 mm - 137 x 125 mm - 137 x 95 mm	multiform
TS2-T2SA	ACSTTSA04	190 x 260 mm - 190 x 230 mm 190 x 137 mm - 95 x 137 mm	multiform
T3SA	ACSTTSA06		multiform
TS300	ACSTTS3001	138 x 96 mm	n. 2
	ACSTTS3002	193 x 138 mm	n. 1
	ACSTTS3003	180 x 180 mm	n. 1
	ACSTTS3004	195 x 260 mm	n. 1
TS400	ACSTTS4001	265 x 320 mm - GN1/2	n. 1
	ACSTTS4002	265 x 160 mm - GN1/4	n. 2
	ACSTTS4003	160 x 130 mm - GN1/8	n. 4
	ACSTTS4004	180 x 180 mm - GN2	n. 2

CAM500TC
CAM700TC
CAM900TC



CAM700TC

Utilizzare solo buste per sottovuoto lisce.
Use only smooth vacuum bags.
N'utilisez que des sachets sous vide lisses.
Nur glatte Vakuüm-Beutel benutzen.
Use sólo bolsas de vacío lisas.
Использовать только гладкие пакеты для вакуума.

Macchine sottovuoto a campana serie TOP

CHAMBER VACUUM PACKERS
MACHINES SOUS VIDE À CLOCHE
KAMMER-VAKUUMVERPACKER
ENVASADORAS AL VACÍO
КОЛПАКОВЫЕ ВАКУУМНЫЕ
УПАКОВОЧНЫЕ МАШИНЫ

IT Macchina per prolungare i tempi di conservazione degli alimenti mantenendone intatte le caratteristiche organoleptiche e impedendone la proliferazione batterica a basse temperature. Carcassa e vasca interna in acciaio inox AISI 304 - vasca con angoli arrotondati - coperchio in plexiglass - apertura automatica del coperchio a fine ciclo - pannello comandi LCD con 20 programmi memorizzabili - funzione di pulizia olio in pompa e soft air inseriti di serie - sistema di saldatura a pistoncini con barra saldante estraibile senza cavi - predisposizione per immissione gas inerte - pompa BUSH (made in Germany) - funzioni step vac ed extra vacuum incluse. Modelli carrellati.















EN Machine aimed at prolonging food preservation times, keeping intact the organoleptic characteristics and preventing the proliferation of bacteria at low temperatures. Stainless steel AISI 304 casing and internal bowl - bowl with rounded corners - plexiglass lid - automatic lid opening at the end of the cycle - LCD control panel with 20 storable programs - oil cleaning function in the pump and soft air function standard included. - piston sealing system with removable sealing bar without cables - provision for inert gas injection - BUSH pump (made in Germany) - "step vac" and "extra vacuum" functions included. Wheeled models.

FR Machine pour prolonger les temps de conservation des aliments, maintenir intactes les caractéristiques organoleptiques et empêcher la prolifération des bactéries à basse température. Corps et cuve intérieure en acier Inox AISI 304 - cuve avec coins arrondis - couvercle en plexiglas - ouverture automatique du couvercle en fin de cycle - panneau de commande LCD avec 20 programmes mémorisables - fonction de nettoyage de l'huile dans la pompe et fonction soft air standard incluse. - Système d'étanchéité de piston avec barre de soudure amovible sans câble - prédisposition d'injection de gaz inerte - pompe BUSH (fabriquée en Allemagne) - fonctions "step vac" et "extra vacuum" incluses. Modèles à roues.

DE Maschine zur Verlängerung der Haltbarkeit von Lebensmitteln, die die organoleptischen Eigenschaften intakt hält und die Vermehrung von Bakterien bei niedrigen Temperaturen verhindert. Gehäuse und Innenschüssel aus Edelstahl AISI 304 - Schüssel mit abgerundeten Ecken - Plexiglasdeckel - automatische Deckelöffnung am Zyklusende - LCD-Bedienfeld mit 20 speicherbaren Programmen - Ölreinigungsfunktion in der Pumpe und Softair-Funktion serienmäßig eingebaut. - Kabelloses Kolbendichtungssystem mit abnehmbarer Schweißleiste - Schutzgaseinspritzung vorgesehen - BUSH-Pumpe (made in Germany) - Funktionen "Step Vac" und "Extra Vakuum" inklusive. Modelle auf Rädern.

ES Máquina para prolongar el tiempo de conservación de los alimentos manteniendo intactas sus características organolépticas y evitando la proliferación bacteriana a bajas temperaturas. Carcasa y bol interior de acero inoxidable AISI 304 - bol interior con esquinas redondeadas - tapa en plexiglas - apertura automática de la tapa al final del ciclo - panel de control LCD con 20 programas que se pueden memorizar - función de limpieza del aceite en la bomba y "soft air" de serie - soldadura con pistones y barra de sellado extraíble y sin cables - equipada para la inyección del gas inerte - bomba BUSH (hecha en Alemania) - funciones de "step vac" y "extra vac" incluidas. Modelos con carro.

RU Машина предназначена для продления сроков хранения продуктов питания, сохранения органолептических свойств и предотвращения размножения бактерий при низких температурах. Корпус из нержавеющей стали AISI 304 и внутренняя чаша - чаша с закругленными углами - крышка из оргстекла - автоматическое открытие крышки в конце цикла - LCD панель управления с 20 сохраняемыми программами - функция очистки масла в насосе и функция мягкого воздуха входит в стандартный комплект поставки. - система поршневого уплотнения со съемной уплотнительной планкой без кабеля - возможность впрыска инертного газа - насос BUSH (немецкого производства) - функция "ступенчатого отпуска" и "дополнительной вакуины" включены. Модели на колесах.

	CAM500TC	CAM700TC	CAM900TC
	1,1 kW (1,5 HP)	1,5 kW (2 HP)	2 kW (2,7 HP)
	-	230-400V/3N/50-60Hz	
	230V/1N/50-60Hz	-	
	500 mm	2 x 700 mm	1 x 500 mm 1 x 900 mm
	20 m³/h	40 m³/h	63 m³/h
	98%		
	520 x 520 x 220(h) mm	720 x 570 x 220(h) mm	920 x 570 x 220(h) mm
	610 x 630 x 1050(h) mm	840 x 680 x 1050(h) mm	1040 x 680 x 1050(h) mm
			
	92 Kg	145 Kg	180 Kg
	107 Kg	160 Kg	205 Kg
	750 x 650 x 1150(h) mm	800 x 870 x 1150(h) mm	1100 x 800 x 1150(h) mm
	0,561 m³	0,800 m³	1,012 m³

Special Voltages - Разное питающее напряжение

CAM300TD
CAM400TD
CAM500TD



CAM400TD

New

Macchine sottovuoto a campana serie TOP

Utilizzare solo buste per sottovuoto lisce.
Use only smooth vacuum bags.
N'utilisez que des sachets sous vide lisses.
Nur glatte Vakuum-Beutel benutzen.
Use sólo bolsas de vacío lisas.
Использовать только гладкие пакеты для вакуума.

CHAMBER VACUUM PACKERS
MACHINES SOUS VIDE À CLOCHE
KAMMER-VAKUUMVERPACKER
ENVASADORAS AL VACÍO
КОЛПАКОВЫЕ ВАКУУМНЫЕ
УПАКОВОЧНЫЕ МАШИНЫ















IT Macchina per prolungare i tempi di conservazione degli alimenti mantenendone intatte le caratteristiche organolettiche e impedendone la proliferazione batterica a basse temperature. Carcassa in acciaio inox - vasca interna in acciaio inox AISI 304 - vasca con angoli arrotondati - coperchio in plexiglass - apertura automatica del coperchio a fine ciclo - pannello comandi LCD da 4,3" TFT a colori con 20 programmi memorizzabili - 9 programmi chef - sensore di vuoto - funzione di pulizia olio in pompa e soft air inseriti di serie - sistema di saldatura a pistoncini con barra saldante estraibile senza cavi - predisposizione per immissione gas inerte - pompa BUSH (made in Germany) - funzioni step vac ed extra vacuum incluse. Modelli da banco.

EN Machine to extend food preservation time while keeping its organoleptic characteristics intact and preventing bacterial growth at low temperatures. Stainless steel casing - AISI 304 stainless steel inner bowl - bowl with rounded corners - plexiglass lid - automatic lid opening at the end of the cycle - 4.3" TFT color LCD control panel with 20 storable programs - 9 chef programs - vacuum sensor - oil cleaning function in pump and soft air fitted as standard - piston sealing system with removable sealing bar without cables - preparation for inert gas input - BUSH pump (made in Germany) - step vac and extra vacuum functions included. Table-top models.

FR Machine permettant de prolonger le temps de conservation des aliments tout en gardant intactes leurs caractéristiques organoleptiques et en empêchant la prolifération bactérienne à basse température. Corps en acier inox - cuve intérieure en acier inox AISI 304 - cuve avec angles arrondis - couvercle en plexiglas - ouverture automatique du couvercle à la fin du cycle - panneau de contrôle LCD couleur TFT 4,3" avec 20 programmes mémorisables - 9 programmes pour cuisiniers - capteur de vide - fonction de nettoyage de l'huile dans la pompe et air doux de série - système de fermeture à piston avec barre de soudure amovible sans câbles - préparation pour l'entrée de gaz inerte - pompe BUSH (fabriquée en Allemagne) - fonctions de vide progressif et de vide supplémentaire incluses. Modèles de table.

DE Maschine zur Verlängerung der Haltbarkeitsdauer von Lebensmitteln, wobei die organoleptischen Eigenschaften erhalten bleiben und das Bakterienwachstum bei niedrigen Temperaturen verhindert wird. Gehäuse aus Edelstahl - Innenbehälter aus Edelstahl AISI 304 - Behälter mit abgerundeten Ecken - Deckel aus Plexiglas - automatisches Öffnen des Deckels am Ende des Zyklus - 4,3" TFT-Farb-LCD-Bedienfeld mit 20 speicherbaren Programmen - 9 Kochprogramme - Vakuumsensor - Ölreinigungsfunktion in der Pumpe und Soft Air serienmäßig eingebaut - Kolbenverschluss mit abnehmbarem Siegelstab ohne Kabel - Vorrüstung für Inertgaszufuhr - BUSH-Pumpe (made in Germany) - Step-Vac- und Extra-Vakuum-Funktionen inklusive. Tischmodelle.

ES Máquina para prolongar el tiempo de conservación de los alimentos manteniendo intactas sus características organolépticas y evitando el crecimiento bacteriano a bajas temperaturas. Carcasa de acero inoxidable - cuba interior de acero inoxidable AISI 304 - cuba con esquinas redondeadas - tapa de plexiglás - apertura automática de la tapa al final del ciclo - panel de control LCD TFT en color de 4,3" con 20 programas almacenables - 9 programas chef - sensor de vacío - función de limpieza de aceite en la bomba y aire suave de serie - sistema de sellado de pistón con barra de sellado extraíble sin cables - preparación para entrada de gas inerte - bomba BUSH (fabricada en Alemania) - funciones step vac y vacío extra incluidas. Modelos de sobremesa.

	CAM300TD	CAM400TD	CAM500TD
	0,75 kW (1 HP)	1,1 kW (1,5 HP)	
	230V/1N/50-60Hz		
	230V/1N/50-60Hz		
	300 mm	400 mm	500 mm
	8 m³/h	18 m³/h	20 m³/h
	98%		
	310 x 350 x 190(h) mm	410 x 450 x 220(h) mm	520 x 520 x 220(h) mm
	410 x 460 x 430(h) mm	510 x 560 x 450(h) mm	610 x 630 x 500(h) mm
			
	38 Kg	60 Kg	72 Kg
	44 Kg	67 Kg	79 Kg
	470 x 550 x 680(h) mm	600 x 650 x 680(h) mm	700 x 700 x 720(h) mm
	0,176 m³	0,265 m³	0,353 m³

Special Voltages - Разное питающее напряжение

RU Машина для увеличения времени хранения продуктов, сохраняя их organoleptические свойства и предотвращая рост бактерий при низких температурах. Корпус из нержавеющей стали - Внутренняя чаша из нержавеющей стали AISI 304 - Чаша со скругленными углами - Крышка из оргстекла - Автоматическое открытие крышки в конце цикла - Цветная ЖК-панель управления 4,3" TFT с 20 сохраненными программами - 9 программ шеф-повара - Датчик вакуума - Функция очистки масла в насосе и мягкий воздух установлены в стандартной комплектации - Поршневая система уплотнения со съемной уплотнительной планкой без кабелей - Подготовка для ввода инертного газа - Насос BUSH (сделано в Германии) - Ступенчатый вакуум и дополнительные функции вакуума включены. Настольные модели.

CAM300ED
CAM350ED
CAM400ED
CAM450ED

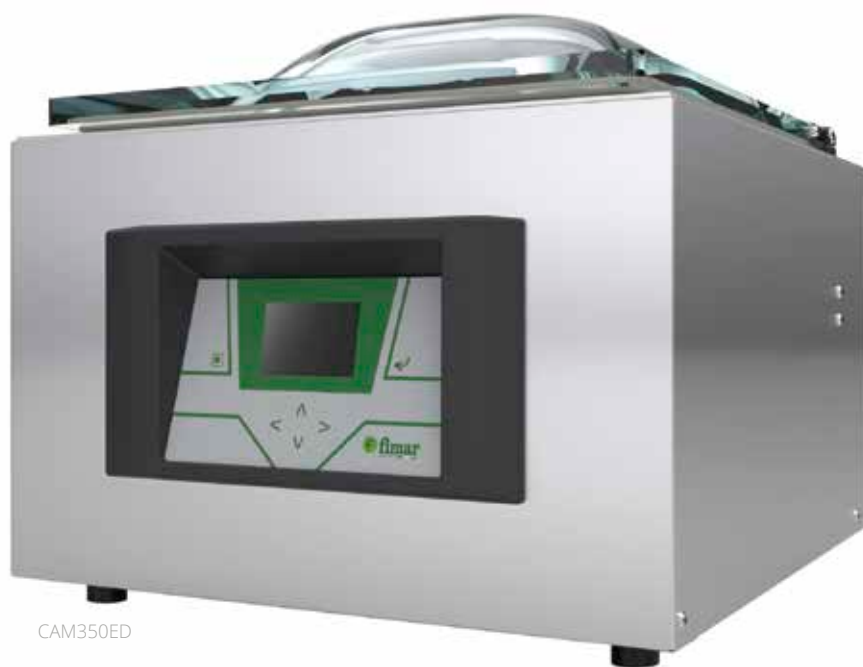

New

Macchine sottovuoto a campana - serie ECO

Utilizzare solo buste per sottovuoto lisce.
Use only smooth vacuum bags.
N'utilisez que des sachets sous vide lisses.
Nur glatte Vakuum-Beutel benutzen.
Use sólo bolsas de vacío lisas.
Использовать только гладкие пакеты для вакуума.

CHAMBER VACUUM PACKERS
MACHINES SOUS VIDE À CLOCHE
KAMMER-VAKUUMVERPACKER
ENVASADORAS AL VACÍO
КОЛПАКОВЫЕ ВАКУУМНЫЕ
УПАКОВОЧНЫЕ МАШИНЫ

IT Macchina per prolungare i tempi di conservazione degli alimenti mantenendone intatte le caratteristiche organolettiche e impedendone la proliferazione batterica a basse temperature. Carcassa in acciaio inox - vasca interna in acciaio inox AISI 304 - vasca con angoli arrotondati - coperchio in plexiglass - apertura automatica del coperchio a fine ciclo - pannello comandi LCD da 3,5" TFT a colori con 5 programmi memorizzabili regolazione del vuoto e della saldatura - sistema di saldatura a pistoni con barra saldante estraibile senza cavi - pompa a bagno d'olio DVP - funzione di marinatura. Modelli da banco.











EN Machine aimed at prolonging food preservation times, keeping intact the organoleptic characteristics and preventing the proliferation of bacteria at low temperatures. Stainless steel casing - AISI 304 stainless steel internal bowl - bowl with rounded corners - plexiglass lid - automatic lid opening at the end of the cycle - 3,5" TFT colour LCD control panel with 5 storable programmes vacuum and sealing adjustment - piston welding system with removable cable-free sealing bar - DVP oil bath pump - marinating function. Countertop models.

FR Machine pour prolonger les temps de conservation des aliments, maintenir intactes les caractéristiques organoleptiques et empêcher la prolifération des bactéries à basse température. Corps en acier inox - cuve intérieure en acier inox AISI 304 - cuve avec coins arrondis - couvercle en plexiglas - ouverture automatique du couvercle en fin de cycle - Panneau de commande LCD couleur TFT 3,5" avec 5 programmes mémorisables réglage du vide et de la soudure - système de soudage à piston avec barre de soudage amovible sans câbles - pompe à bain d'huile DVP. fonction de marinade. Modèles de table.

DE Maschine zur Verlängerung der Haltbarkeit von Lebensmitteln, die die organoleptischen Eigenschaften intakt hält und die Vermehrung von Bakterien bei niedrigen Temperaturen verhindert. Gehäuse aus Edelstahl - Innenschüssel aus Edelstahl AISI 304 - Schüssel mit abgerundeten Ecken - Plexiglasdeckel - automatische Deckelöffnung am Zyklusende - 3,5" TFT-LCD-Farbdisplay mit 5 speicherbaren Programmen - Vakuum- und Siegeleinstellung - Kolbensiegelsystem mit abnehmbarer Siegelschiene ohne Kabel - DVP-Ölbadpumpe - Marinierfunktion. Tischmodelle.

ES Máquina para prolongar el tiempo de conservación de los alimentos manteniendo intactas sus características organolépticas y evitando la proliferación bacteriana a bajas temperaturas. Carcasa de acero inoxidable - bol interior de acero inoxidable AISI 304 - bol interior con esquinas redondeadas - tapa en plexiglás - apertura automática de la tapa al final del ciclo - panel de control TFT LCD en color de 3,5" con 5 programas memorizables ajuste de vacío y sellado - sistema de sellado de pistón con barra de sellado extraíble sin cables - bomba de baño de aceite DVP. Modelos de mostrador.

RU Машина для продления сроков хранения пищевых продуктов при сохранении их organoleptic характеристик нетронутыми и предотвращение их бактериального размножения при низких температурах. Корпус из нержавеющей стали - внутренняя ванна из нержавеющей стали AISI 304 - ванна с закругленными углами - крышка из плексигла - автоматическое открытие крышки в конце цикла - 3,5" ЖК-панель управления Цвет TFT с 5 программами storable регулировка вакуума и сварки - система сварки поршня с кабельно-свободным вытягиваемым сварочным стержнем - насос DVP масляной ванны - marinating функция. Типовые модели.

	CAM300ED	CAM350ED	CAM400ED	CAM450ED
	0,75 kW (1 HP)	0,85 kW (1,2 HP)	1,1 kW (1,5 HP)	
 1 Ph	230V/1N/50-60Hz			
BARRA SALDANTE/ HOT-WELD SEALER	300 mm	350 mm	400 mm	450 mm
POMPA VUOTO/ VACUUM PUMP	8 m³/h	12 m³/h	20 m³/h	
VUOTO MAX OTTENIBILE/ MAX ACHIEVABLE VACUUM	98%			
 mm	310 x 350 x 190(h) mm	360 x 400 x 190(h) mm	410 x 450 x 220(h) mm	460 x 500 x 220(h) mm
 mm	410 x 460 x 430(h) mm	460 x 500 x 430(h) mm	510 x 560 x 450(h) mm	560 x 610 x 460(h) mm
				
 Kg	38 Kg	42 Kg	60 Kg	65 Kg
 Kg	44 Kg	48 Kg	67 Kg	72 Kg
 mm	470 x 550 x 680(h) mm	600 x 650 x 680(h) mm		700 x 700 x 720(h) mm
 m³	0,176 m³	0,265 m³		0,353 m³

Special Voltages - Разное питающее напряжение

MSD300P BAR300P-BAR350 BAR400-BAR500



MSD300P



BAR300P



BAR350



BAR400/500

Macchine sottovuoto a barra saldante

BAR VACUUM PACKERS
MACHINES SOUS VIDE À BARRE
VAKUUMVERPACKER MIT SCHWEISSLEISTE
ENVASADORAS AL VACÍO CON BARRA
ВАКУУМНЫЕ УПАКОВОЧНЫЕ МАШИНЫ СО
СВАРОЧНОЙ ПЛАНКОЙ



IT Macchine per prolungare i tempi di conservazione degli alimenti mantenendone intatte le caratteristiche organolettiche. Tramite l'utilizzo di apposite buste goffrate o contenitori si crea un livello di vuoto tale, da impedire la proliferazione batterica a bassa temperatura. Tutte le macchine sottovuoto supportano il vuoto in sacchetti o contenitori completi di coperchi specifici per l'utilizzo.

MSD300P: Carcassa in plastica - elettrovalvola apertura rapida barra - pompa a secco automatica - pannello comandi digitale - provvista di sensore di regolazione altimetrica.

BAR300P: Robusta carcassa in ABS e acciaio inox - pompa a secco - pannello comandi digitale.

BAR350: Carcassa in acciaio inox - pompa a secco - pannello comandi digitale per saldatura manuale oppure tramite due programmi di lavoro pre-impostati.

BAR400 - BAR500: Carcassa in acciaio inox AISI 304 - pompa a secco per il modello BAR400 - pompa a bagno d'olio per il modello BAR500 - pannello comandi digitale per programmare il tempo di saldatura e di vuoto - start automatico nell'abbassamento della barra superiore - apertura automatica della barra a fine ciclo.

FR Machine pour prolonger les temps de conservation des aliments et maintenir intactes les caractéristiques organoleptiques. Grâce à l'usage de spéciales sachets ou conteneurs, il est possible créer un niveau de vide, tel de empêcher la prolifération bactérien à baisse température. Toutes les machines soutiennent le vide en sachets ou bien en conteneurs complets de couvercles spécifiques ce type d'usage.

MSD300P: Corps en plastic - électrovanne d'ouverture rapide de la barre - pompe à sec - automatiques - panneau des commandes digital - munis de capteur de réglage altimétrique.

BAR300P: corps robuste en ABS et acier inox - pompe à sec - panneau des commandes digital.

BAR350: corps en acier inox - pompe à sec - panneau des commandes digital pour soudure manuelle, ou bien à travers deux programmes de travail pré-réglés.

BAR400 - BAR500: Corps en acier Inox AISI 304 - pompe sèche pour le modèle BAR400 - pompe à bain d'huile pour le modèle BAR500 - panneau de commande numérique pour programmer le temps de soudage et de vide - démarrage automatique lors de la descente de la barre supérieure - ouverture automatique de la barre à la fin du cycle.

ES Máquina para prolongar el tiempo de conservación de los alimentos manteniendo sus características organolépticas. A través del uso de bolsas o contenedores especiales se produce un nivel de vacío que impide la proliferación bacteriana a baja temperatura. Todas las envasadoras al vacío pueden hacer vacío en bolsas o contenedores con tapas específicas para el uso.

MSD300P: Carcasa de plástico - electroválvula abertura rápida de la barra - bomba a seco - automática - digital - dotado de sensor de regulación altimétrica

BAR300P: Carcasa fuerte en ABS y acero inoxidable - bomba en seco - panel de control digital.

BAR350: Carcasa de acero inoxidable - bomba en seco - panel de control digital para la soldadura manual o por medio de dos programas de trabajo preestablecidos.

BAR400 - BAR500: Carcasa de acero inoxidable AISI 304 - bomba a seco en el modelo BAR400, de baño de aceite en el modelo BAR500 - panel de control digital para regular el tiempo de soldadura y de vacío - start automático al bajar la barra superior - apertura automática de la barra al final del ciclo.

EN Machine aimed at prolonging food preservation times, keeping intact the organoleptic characteristics. The use of specific embossed bags or containers creates a vacuum level that keeps intact the organoleptic characteristics and prevents the proliferation of bacteria at low temperatures. All vacuum machines can be used for vacuum in bags or containers with lids specifically designed for this purpose.

MSD300P: Plastic casing - solenoid valve quick bar opening - automatic dry pump - digital control panel - with height adjustment sensor.

BAR300P: Robust ABS and stainless steel casing - dry pump - digital control panel.

BAR350: Stainless steel casing - dry pump - digital control panel for manual sealing or by using two pre-set programs.

BAR400 - BAR500: Stainless steel AISI 304 casing - dry pump for BAR400 model - oil bath pump for BAR500 model - digital control panel to set sealing and vacuum time - automatic start when lowering the upper bar - automatic bar opening at the end of the cycle.

DE Maschine zur Verlängerung der Haltbarkeit von Lebensmitteln, die die organoleptischen Eigenschaften intakt hält. Die Verwendung von speziellen geprägten Beuteln oder Behältern erzeugt ein Vakuumniveau, das die Vermehrung von Bakterien bei niedrigen Temperaturen verhindert. Alle Vakuumaschinen können für das Vakuum in Beuteln oder Behältern mit speziellen Deckeln eingesetzt werden.

MSD300P: Kunststoffgehäuse - Magnetventil mit Schnellverschluss - Trockenpumpe - automatisch - digital - ausgestattet mit Höheneinstellsensor.

BAR300P: Robustes ABS- und Edelstahlgehäuse - Trockene Pumpe - Digitales Bedienfeld.

BAR350: Edelstahlgehäuse - Trockene Pumpe - Digitales Bedienfeld für manuelle Versiegelung oder mit zwei voreingestellten Programmen. Alle Vakuumaschinen können für das Vakuum in Beuteln oder Behältern mit speziellen Deckeln eingesetzt werden.

BAR400 - BAR500: Gehäuse aus Edelstahl AISI 304 - Trockenpumpe für das Modell BAR400, Ölbadpumpe für das Modell BAR500 - digitales Bedienfeld zur Programmierung von Schweiß- und Vakuumzeit - automatischer Start beim Absenken des oberen Stabes - automatische Öffnung des Stabes am Ende des Zyklus.









RU Машина предназначена для продления сроков хранения продуктов питания, сохранения органолептических свойств. Использование специальных тисненых пакетов или контейнеров создает уровень вакуума, который сохраняет органолептические свойства и предотвращает размножение бактерий при низких температурах. Все вакуумные машины могут быть использованы для вакуума в мешках или контейнерах с соответствующими крышками.

MSD300P: Пластиковый корпус - электромагнитный клапан быстрого открытия барной стойки - сухой насос - автоматический - цифровой - оснащен датчиком регулировки высоты.

BAR300P: Прочный корпус из ABS и нержавеющей стали - сухой насос - цифровая панель управления.

BAR350: Корпус из нержавеющей стали - сухой насос - цифровая панель управления для ручного уплотнения или с помощью двух предустановленных программ. Все вакуумные машины могут быть использованы для вакуума в мешках или контейнерах с соответствующими крышками.

BAR400 - BAR500: Корпус из нержавеющей стали AISI 304 - сухой насос для модели BAR400, масляный насос для модели BAR500 - цифровая панель управления для программирования времени сварки и вакуума - автоматический запуск при опускании верхней штанги - автоматическое открытие штанги в конце цикла.

	MSD300P	BAR300P	BAR350	BAR400	BAR500
	0,49 kW (0,7 HP)	0,45 kW (0,6 HP)		0,55 kW (0,7 HP)	0,75 kW (1 HP)
	230V/1N/50-60Hz	230V/1N/50Hz			230V/1N/50-60Hz
BARRA SALDANTE/ HOT-WELD SEALER	320 mm	300 mm	350 mm	400 mm	500 mm
POMPA VUOTO/ VACUUM PUMP	0,9 m³/h	1,2 m³/h		2,4 m³/h	4 m³/h
VUOTO MAX OTTENIBILE/ MAX ACHIEVABLE VACUUM	80%	85%			98%
	390 x 310 x 140(h) mm	320 x 260 x 140(h) mm	370 x 280 x 170(h) mm	420 x 280 x 180(h) mm	520 x 380 x 210(h) mm
					
	4,5 Kg	6 Kg	8 Kg	13 Kg	23 Kg
	5,5 Kg	7 Kg	9 Kg	14 Kg	24 Kg
	420 x 350 x 190(h) mm	420 x 290 x 210(h) mm	510 x 330 x 245(h) mm	550 x 365 x 250(h) mm	610 x 420 x 300(h) mm
	0,028 m³	0,025 m³	0,040 m³	0,050 m³	0,076 m³

Special Voltages - Разное питающее напряжение

Utilizzare solo buste per sottovuoto goffrate.
Use only embossed bags.
Utiliser seulement les sachets gauffrés.
Nur gaufrierte Beutel fuer vakuum benuzten.
Usar solo bolsas para envasado al vacío gofradas.
Использовать только пакеты для вакуума с тиснением.

Optional

ACCESSORIES
ACCESSOIRES
ZUBEHÖR
ACCESORIOS
AKCECCYAPY

Buste goffrate e lisce - Embossed and smooth bags - Sacs gaufrés et lisses - Geprägte und Glatte Beutel - Bolsas gofrados y lisas - Тисненные и гладкие конверты

	Confezione 100 pz - Pack 100 pcs - 100 pièces par paquet 100 Stk. Packung - 100 uds. por caja - 100 шт. в упаковке	Temp. max / h	 mm
SAC03	µm 90 Buste Goffrate - Conservazione e cottura Embossed bags - Preservation and cooking Sacs gaufrés - Conservation et cuisson Geprägte Beutel - Konservieren und kochen Bolsas gofrados - Conservación y cocina Конверты с тиснением - хранение и приготовление	100°C - 2 h	150 x 300 mm
SAC01			200 x 300 mm
SAC19			200 x 400 mm
SAC05			250 x 350 mm
SAC02			300 x 400 mm
SAC18			400 x 600 mm
SAC03C	µm 90 Buste Goffrate per cottura extra performance Embossed bags for extra performance cooking Sacs gaufrés pour une cuisson encore plus performante Geprägte Beutel für besonders leistungsstarkes Kochen Bolsas gofradas para una cocción de mayor rendimiento Рельефные пакеты для более эффективного приготовления	120°C - 4 h	150 x 300 mm
SAC01C			200 x 300 mm
SAC02C			300 x 400 mm
SAC18C			400 x 600 mm
SAC27C	µm 90 Buste lisce - Conservazione e cottura Smooth bags - Preservation and cooking Sacs lisses - Conservation et cuisson Glatte Beutel - Konservieren und kochen Bolsas lisas - Conservación y cocina Гладкие пакеты - Хранение и приготовление пищи	100°C - 2 h	150 x 300 mm
SAC11			200 x 300 mm
SAC12			250 x 350 mm
SAC14			300 x 400 mm
SAC16			400 x 500 mm

2 rotoli - 2 rolls - 2 rouleaux - 2 Rollen - 2 rollos - 2 рулонов

	 mm
ROT01	200 x 6000 mm
ROT02	300 x 6000 mm

ROT01

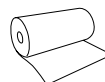

ROT02

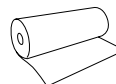

Rotolo di carta adesiva per stampante - Adhesive printer paper roll
Rouleau de papier adhésif pour imprimante - Klebepapierrolle für Drucker
Rollo de papel adhesivo para impresora - Рулон клейкой бумаги для печатающего устройства

Mod.

CAM500TC - CAM700TC - CAM900TC

Barra saldante aggiuntiva - Additional sealing bar
Barre de soudure supplémentaire
Zusätzliche Schweißstange - Barra selladora añadida
Дополнительная сварочная планка для моделей

Configurazione barre fuori standard - Non-standard bar configuration
Configuration des barres hors standards - Nicht standardmäßige
Stangenkonfiguration - Configuración de las barras fuera estándar
Конфигурация нестандартных планок

Mod.

CAM500TC - CAM700TC - CAM900TC

CAM500TC

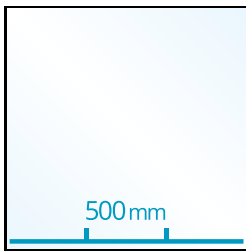

STANDARD

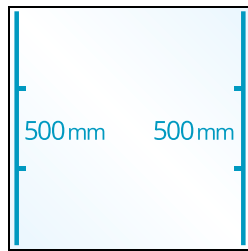

OPTIONAL

CAM700TC

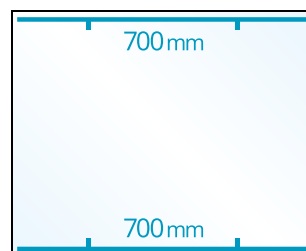

STANDARD

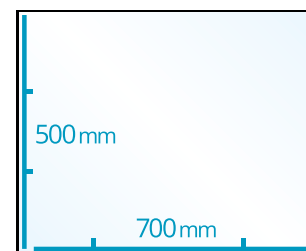

OPTIONAL



CAM900TC

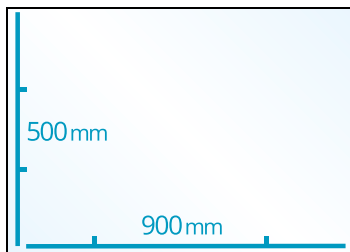

STANDARD

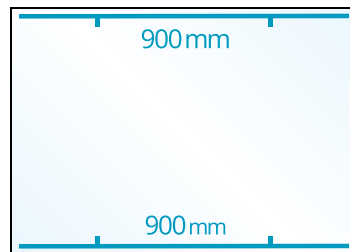

OPTIONAL

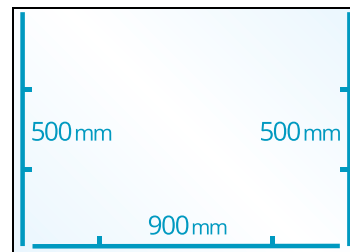





Cottura

COOKING
CUISSON
KOCHEŃ
COCCIÓN
ПРИГОТОВЛЕНИЕ

IT

La linea cottura risponde alle esigenze di ogni tipo di richiesta, dalla più moderna cottura Sous-Vide, ai tradizionali Forni Elettrici per Pizza, Forni a Convezione o Forni a Gas, con i relativi accessori come Armadi Lievitori, Celle per la Lievitazione e Cappe a condensazione. Ma non solo, anche Cucine, Griglie a Pietra Lavica, Brasiere, Fry Top, Gyros Elettrici e a Gas, Friggitrici, Cuocipasta e Salamandre.

FR

La ligne de cuisson répond aux besoins de chaque type de demande, de la plus moderne cuisson Sous-Vide, aux traditionnels fours à pizza électriques, fours à convection ou fours à gaz, avec les accessoires correspondants tels que les armoires de levure, cellules de levure et hottes à condensation. Non seulement cela, mais aussi des cuisinières, des grilles à pierre lavique, des sauteuses, des Fry-Tops, des gyros électriques et à gaz, des friteuses, des cuiseurs à pâtes et des salamandres.

ES

La línea de cocción responde a diferentes necesidades, de la más moderna cocción sous-vide, a los tradicionales hornos eléctricos para pizza, hornos de convección o hornos de gas, con los relativos accesorios como armarios de fermentación, cámaras para la fermentación, campana de condensación. Además en nuestro catálogo se encuentran cocinas, parrillas, piedras lavicas, ollas de cocción lenta, Fry Top, gyros eléctricos y de gas, freidoras, cocedor de pasta y salamandras.

EN

The cooking line meets the needs of every type of request, from the most modern Sous-Vide cooking, to the traditional Electric Pizza Ovens, Convection Ovens or Gas Ovens, with their accessories such as Proving Cabinets, Proving Cells and Condensing Hoods. Moreover, there are also ranges, lava stone grills, brat pans, fry tops, electric and gas gyros, fryers, pasta cookers and salamanders.

DE

Die Kochlinie erfüllt die Bedürfnisse aller Arten von Anforderungen, von der modernsten Sous-Vide-Küche bis zu den traditionellen elektrischen Pizzaöfen, Konvektions- oder Gasöfen, mit dem entsprechenden Zubehör wie Gärschränke, Gärzellen und Kondensationshauben. Nicht nur das, sondern auch Herde, Lavasteingrill, Fry Tops, Elektrik- und Gasgyros, Friteusen, Pastakoher und Salamander.

RU

Линия готовки отвечает всем требованиям, от самых современных духовых шкафов до традиционных электрических пиццерий, конвекционных и газовых печей, с соответствующими принадлежностями, такими как дрожжевые шкафы, дрожжевые камеры и конденсационные вытяжки. И не только это, но и кухни, каменные грили Lava, жаровни, жаровни, электрические и газовые гироскопы, фритюрницы, макаронные плиты и саламандры.

SV25
RH60



SV25

New

DISPONIBILE DA
AVAILABLE FROM 01/2026



RH60

Cottura sous-vide

SOUS-VIDE COOKING
CUISSON SOUS-VIDE
VAKUUM GAREN
COCCIÓN SOUS-VIDE
ВАКУУМНАЯ ВАПКА



GUARDA IL VIDEO
WATCH THE VIDEO

IT Macchine per la cottura sottovuoto a bassa temperatura (sous-vide) con display per la visualizzazione delle temperature dell' acqua da 0 a 99°C - blocco macchina in mancanza di acqua - sensore temperatura con delta 0,1°C.
SV25: Scheda di controllo con 5 programmi di cottura - precisione di lavorazione +/- 0,3°C - vasca in acciaio inox e rubinetti di scarico con valvola di sicurezza - raggiunge i 70°C in circa 50' - capacità di scaldare fino a 25 L di acqua. Optional: sonda al cuore.

RH60: raggiunge i 70°C in circa 30' - capacità di scaldare fino a 56 L di acqua.

EN Low-temperature vacuum cooking machines (sous-vide) with water temperature display from 0 to 99°C - machine shutdown in case of lack of water - temperature sensor with 0,1°C delta.

SV25: Control board with 5 cooking programmes - processing accuracy +/- 0,3°C - stainless steel tank and drain cocks with safety valve - reaches 70°C in about 50' - for up to 25 L of water. Optional: core probe.

RH60: reaches 70°C in about 30' - for up to 56 L of water.

FR Machines de cuisson sous-vide à basse température avec écran d'affichage de la température de l'eau de 0 à 99°C - arrêt de la machine en cas de manque d'eau - sonde de température avec delta de 0,1°C.

SV25: Panneau de contrôle avec 5 programmes de cuisson - précision de traitement +/- 0,3°C - cuve et robinets de vidange en acier inox avec soupape de sécurité - atteint 70°C en 50' environ - capacité jusqu'à 25 L d'eau. En option: sonde à cœur.

RH60: atteint 70°C en 30' environ - capacité jusqu'à 56 L d'eau.

DE Niedertemperatur-Vakuumgarer (Sous-vide) mit Wassertemperaturanzeige von 0 bis 99°C - Gerät schaltet bei Wassermangel ab - Temperaturfühler mit Delta von 0,1°C.

SV25: Bedienfeld mit 5 Kochprogrammen - Prozessgenauigkeit +/- 0,3°C - Wannen- und Ablassventile aus Edelstahl mit Sicherheitsventil - erreicht 70°C in etwa 50' - Wasserkapazität bis zu 25 L.

RH60: erreicht 70°C in etwa 30' - Wasserkapazität bis zu 56 Liter.

ES Cocedoras al vacío de baja temperatura (sous-vide) con indicación de la temperatura del agua de 0 a 99°C - la máquina se para si se acaba el agua - sonda de temperatura con delta de 0,1°C.



SV25: Panel de mandos con 5 programas de cocción - precisión de proceso +/- 0,3°C - cuba y grifos de vaciado de acero inoxidable con válvula de seguridad - alcanza los 70°C en unos 50' - capacidad de agua hasta 25 L. Sonda al corazón opcional.

RH60: alcanza 70°C en unos 30' - capacidad hasta 56 litros de agua.

RU Низкотемпературные вакуумные варочные аппараты (sous-vide) с индикацией температуры воды от 0 до 99°C - аппарат останавливается, если заканчивается вода - температурный щуп с дельтой 0,1°C.

SV25: панель управления с 5 программами приготовления - точность обработки +/- 0,3°C - бак из нержавеющей стали и сливные краны с предохранительным клапаном - достигает 70°C примерно за 50' - емкость для воды до 25 л. Дополнительный термомощуп.

RH60: достигает 70°C примерно за 30' - объем воды до 56 л.

	SV25	RH60
		
	2 kW	
 1 Ph	230V/1N/50-60Hz	
	25 L	56 L
	640 x 350 x 330(h) mm	160 x 196 x 419(h) mm
		
 NET Kg	13 Kg	4,5 Kg
 GROSS Kg	14 Kg	5 Kg
 mm	700 x 470 x 380(h) mm	300 x 250 x 480(h) mm
 m³	0,125 m³	0,036 m³

Special Voltages - Разное питающее напряжение

	SONDASV
	Sonda al cuore - Core probe - Sonde à cœur Kerntemperaturfühler - Sonda al corazón - Щуп продукта
Mod.	SV25



FMD - FMDW



FMD44



FMD44

Forni pizza elettrici digitali

DIGITAL ELECTRIC PIZZA OVENS
FOURS À PIZZA ÉLECTRIQUES NUMÉRIQUES
DIGITALE ELEKTRISCHE PIZZAÖFEN
HORNOS ELÉCTRICOS DIGITALES PARA PIZZA
ЦИФРОВЫЕ ЭЛЕКТРИЧЕСКИЕ ПЕЧИ ДЛЯ ПИЦЦЫ

IT Forni elettrici professionali per la cottura di pizza, focacce, ecc. Rivestimento frontale inox - camera di cottura interamente refrattaria - pannello comandi digitale - isolamento termico mediante rivestimento in lana di roccia - porte con vetro di ispezione in pirex - illuminazione interna. Versione forni "W" con dimensioni della camera cottura invertite (più larghi e meno profondi).

EN Professional electric ovens for baking pizza, focaccia, etc. Stainless steel front panel - fully refractory cooking chamber - digital control panel - heat insulation by means of rock wool coating - doors with pyrex inspection glass - internal lighting. "W" oven version with inverted cooking chamber dimensions (wider and narrower).













FR Fours électriques professionnels pour la cuisson de pizzas, focaccia, etc. Revêtement frontal en acier Inox - chambre de cuisson entièrement réfractaire - tableau de commande numérique - isolation thermique par revêtement en laine de roche - portes avec vitred'inspection en pyrex - éclairage intérieur. Version "W" avec chambre de cuisson inversée (plus large et moins profonde).

DE Professionelle Elektrobacköfen zum Backen von Pizza, Focaccia, usw. Edelstahl-Frontblende - voll feuerfester Garraum - digitales Bedienfeld - Wärmedämmung durch Steinwolleverkleidung - Türen mit Pyrex-Schauglas - Innenbeleuchtung. Ofenvariante "W" mit umgekehrten Garraummaßen (breiter und geringer).













ES Hornos eléctricos profesionales para hornear pizza, focaccia, etc. Revestimiento frontal de acero inoxidable - cámara de cocción totalmente refractaria - panel de control digital - aislamiento térmico mediante revestimiento de lana de roca - puertas con cristal de inspección pyrex - iluminación interior. Versión de horno "W" con cámara de cocción invertida (más ancha y menos profunda).

RU Профессиональные электрические печи для выпечки пиццы, focaccia и т.д. Передняя облицовка из нержавеющей стали - полностью огнеупорная варочная камера - цифровая панель управления - теплоизоляция благодаря облицовке минеральной ватой - двери с закаленным смотровым стеклом - внутреннее освещение. Вариант печи "W" с инвертированными размерами варочной камеры (шире и меньше).



	FMD4	FMD44	FMD6	FMDW6	FMD66	FMDW66
	6 kW (1 Ph - 27A) (3 Ph - 9A)	12 kW (1 Ph - 54A) (3 Ph - 18A)	9 kW (1 Ph - 36A) (3 Ph - 12A)		18 kW (1 Ph - 72A) (3 Ph - 24A)	
	230-400V/3N/50-60Hz					
	230V/1N/50-60Hz					
	50±500°C					
	Digitale - Digital - Цифровой					
	720 x 720 x 140(h) mm	720 x 720 x 140(h) mm x2	720 x 1080 x 140(h) mm	1080 x 720 x 140(h) mm	720 x 1080 x 140(h) mm x2	1080 x 720 x 140(h) mm x2
	1150 x 850 x 420(h) mm	1150 x 850 x 750(h) mm	1150 x 1210 x 420(h) mm	1520 x 850 x 420(h) mm	1150 x 1210 x 750(h) mm	1520 x 850 x 750(h) mm
						
	135 Kg	235 Kg	195 Kg	200 Kg	350 Kg	365 Kg
	157 Kg	262 Kg	222 Kg	225 Kg	377 Kg	390 Kg
	1250 x 1040 x 570(h) mm	1250 x 1040 x 920(h) mm	1250 x 1400 x 570(h) mm	1650 x 1040 x 570(h) mm	1250 x 1400 x 920(h) mm	1650 x 1040 x 920(h) mm
	0,741 m ³	1,196 m ³	0,998 m ³	0,978 m ³	1,610 m ³	1,579 m ³

Special Voltages - Разное питающее напряжение

	FMD9	FMD99
	13,2 kW (1 Ph - 60A) (3 Ph - 20A)	26,4 kW (3 Ph - 40A)
 3 Ph	230-400V/3N/50-60Hz	
 1 Ph	230V/1N/50-60Hz	-
	50÷500°C	
	Digitale - Digital - Цифровой	
	1080 x 1080 x 140(h) mm	1080 x 1080 x 140(h) mm x2
 mm	1520 x 1210 x 420(h) mm	1520 x 1210 x 750(h) mm
		
 NET Kg	225 Kg	465 Kg
 GROSS Kg	275 Kg	485 Kg
 mm	1650 x 1400 x 570(h) mm	1650 x 1400 x 920(h) mm
 m³	1,317 m³	2,123 m³

Special Voltages - Разное питающее напряжение



FML - FMLW
FME - FMEW



FME4



FML6

Forni pizza elettrici

ELECTRIC PIZZA OVENS
FOURS À PIZZA ÉLECTRIQUES
ELEKTRISCHE PIZZAÖFEN
HORNOS ELÉCTRICOS PARA PIZZA
ЭЛЕКТРИЧЕСКИЕ ПЕЧИ ДЛЯ ПИЦЦЫ

IT Forni elettrici professionali per la cottura di pizza, focacce, ecc. Rivestimento frontale inox - piano di cottura refrattario - isolamento termico mediante rivestimento in lana di roccia - porte con vetro di ispezione in pirex - pirometri - illuminazione interna - 2 termostati per ogni camera. Versione forni "W" con dimensioni della camera cottura invertite (più larghi e meno profondi).

EN Professional electric ovens for baking pizza, focaccia, etc. Stainless steel on the front - refractory cooking surface - thermal insulation by means of rock wool coating - doors with pyrex inspection glass - pyrometers - internal lighting - 2 thermostats for each chamber. "W" oven version with inverted cooking chamber dimensions (wider and narrower).

FR Fours électriques professionnels pour la cuisson de pizzas, focaccia, etc. - Revêtement frontal en acier Inox - plaque de cuisson réfractaire - isolation thermique par laine de roche - portes avec vitre d'inspection en pyrex - pyromètres - éclairage intérieur - 2 thermostats pour chaque chambre. Version "W" avec chambre de cuisson inversée (plus large et moins profonde).













DE Professionelle Elektrobacköfen zum Backen von Pizza, Focaccia, usw. Edelstahl-Frontblende - hitzebeständige Kochfläche - digitales Bedienfeld - Wärmedämmung durch Steinwolleverkleidung - Türen mit Pyrex-Schauglas - Pyrometer - Innenbeleuchtung - 2 Thermostate pro Garraum. Ofenvariante "W" mit umgekehrten Garraummaßen (breiter und geringer).

ES Hornos eléctricos profesionales para hornear pizza, focaccia, etc. Revestimiento frontal de acero inoxidable - encimera refractaria - aislamiento térmico mediante revestimiento de lana de roca - puertas con cristal de inspección pyrex - pirómetros - iluminación interna - 2 termostatos para cada cámara. Versión de horno "W" con cámara de cocción invertida (más ancha y menos profunda).













RU Профессиональные электрические печи для выпечки пиццы, фокачки и т.д. нержавеющая сталь - огнеупорная варочная поверхность - теплоизоляция с помощью покрытия из минеральной ваты - двери с закаленным смотровым стеклом - пирометры - внутреннее освещение - по 2 термостата для каждой камеры. Вариант печи "W" с инвертированными размерами варочной камеры (шире и меньше).



FML44

	FML4	FML44	FML6	FMLW6	FML66	FMLW66	FML9	FML99
	6 kW (1 Ph - 27A) (3 Ph - 9A)	12 kW (1 Ph - 54A) (3 Ph - 18A)	9 kW (1 Ph - 36A) (3 Ph - 12A)		18 kW (1 Ph - 72A) (3 Ph - 24A)		13,2 kW (1 Ph - 60A) (3 Ph - 20A)	26,4 kW (3 Ph - 40A)
	230-400V/3N/50-60Hz							
	230V/1N/50-60Hz							-
	50±500°C							
	720 x 720 x 140(h) mm	720 x 720 x 140(h) mm x2	720 x 1080 x 140(h) mm	1080 x 720 x 140(h) mm	720 x 1080 x 140(h) mm x2	1080 x 720 x 140(h) mm x2	1080 x 1080 x 140(h) mm	1080 x 1080 x 140(h) mm x2
	1010 x 850 x 420(h) mm	1010 x 850 x 750(h) mm	1010 x 1210 x 420(h) mm	1370 x 850 x 420(h) mm	1010 x 1210 x 750(h) mm	1370 x 850 x 750(h) mm	1370 x 1210 x 420(h) mm	1370 x 1210 x 750(h) mm
								
	86 Kg	146 Kg	116 Kg	130 Kg	200 Kg	215 Kg	170 Kg	350 Kg
	108 Kg	173 Kg	143 Kg	155 Kg	231 Kg	240 Kg	190 Kg	370 Kg
	1090 x 1040 x 570(h) mm	1090 x 1040 x 920(h) mm	1090 x 1400 x 570(h) mm	1450 x 1040 x 570(h) mm	1090 x 1400 x 920(h) mm	1450 x 1040 x 920(h) mm	1450 x 1400 x 570(h) mm	1450 x 1400 x 920(h) mm
	0,657 m³	1,032 m³	0,885 m³	0,860 m³	1,389 m³	1,387 m³	1,198 m³	1,827 m³

Special Voltages - Разное питающее напряжение

	FME4	FME44	FME6	FMEW6	FME66	FMEW66	FME9	FME99
	4,2 kW (1 Ph - 20A) (3 Ph - 7A)	8,4 kW (1 Ph - 40A) (3 Ph - 15A)	7,2 kW (1 Ph - 30A) (3 Ph - 10A)	6,4 kW (1 Ph - 28A) (3 Ph - 10A)	14,4 kW (1 Ph - 63A) (3 Ph - 21A)	12,8 kW (1 Ph - 55A) (3 Ph - 19A)	9,6 kW (1 Ph - 42A) (3 Ph - 16A)	19,2 kW (3 Ph - 33A)
	230-400V/3N/50-60Hz							
	230V/1N/50-60Hz							-
	50±500°C							
	610 x 610 x 140(h) mm	610 x 610 x 140(h) mm x2	610 x 915 x 140(h) mm	915 x 610 x 140(h) mm	610 x 915 x 140(h) mm x2	915 x 610 x 140(h) mm x2	910 x 910 x 140(h) mm	910 x 910 x 140(h) mm x2
	900 x 735 x 420(h) mm	900 x 735 x 750(h) mm	900 x 1020 x 420(h) mm	1150 x 735 x 420(h) mm	900 x 1020 x 750(h) mm	1150 x 735 x 750(h) mm	1150 x 1020 x 420(h) mm	1150 x 1020 x 750(h) mm
								
	66 Kg	114 Kg	85 Kg	100 Kg	150 Kg	187 Kg	115 Kg	252 Kg
	86 Kg	139 Kg	110 Kg	125 Kg	179 Kg	212 Kg	145 Kg	275 Kg
	1000 x 960 x 570(h) mm	1000 x 960 x 920(h) mm	1210 x 960 x 570(h) mm	1250 x 960 x 570(h) mm	1210 x 960 x 920(h) mm	1250 x 960 x 920(h) mm	1210 x 1210 x 570(h) mm	1210 x 1210 x 920(h) mm
	0,547 m ³	0,883 m ³	0,669 m ³	0,684 m ³	1,068 m ³	1,104 m ³	0,835 m ³	1,347 m ³

Special Voltages - Разное питающее напряжение

FYL - FES



FYL44



FES4

Forni pizza elettrici

ELECTRIC PIZZA OVENS
FOURS À PIZZA ÉLECTRIQUES
ELEKTRISCHE PIZZAÖFEN
HORNOS ELÉCTRICOS PARA PIZZA
ЭЛЕКТРИЧЕСКИЕ ПЕЧИ ДЛЯ ПИЦЦЫ

- IT Forni elettrici professionali per la cottura di pizza, focacce, ecc. Rivestimento frontale inox - piano di cottura refrattario - isolamento termico mediante rivestimento in lana di roccia - porte con vetro di ispezione in pyrex - illuminazione interna - 2 termostati per ogni camera.
- EN Professional electric ovens for baking pizza, focaccia, etc. Stainless steel covering on the front - refractory cooking surface - thermal insulation by means of rock wool coating - doors with pyrex inspection glass - internal lighting - 2 thermostats for each chamber.
- FR Fours électriques professionnels pour la cuisson de pizzas, focaccia, etc. Revêtement frontal en acier Inox - plaque de cuisson réfractaire - isolation thermique par laine de roche - portes avec vitre d'inspection en pyrex - éclairage intérieur - 2 thermostats pour chaque chambre.













- DE Professionelle Elektrobacköfen zum Backen von Pizza, Focaccia, usw. Edelstahl Frontblende - hitzebeständige Kochfläche - digitales Bedienfeld - Wärmedämmung durch Steinwolleverkleidung - Türen mit Pyrex-Schauglas - Innenbeleuchtung - 2 Thermostate pro Garraum.
- ES Hornos eléctricos profesionales para hornear pizza, focaccia, etc. Revestimiento frontal de acero inoxidable - encimera refractaria - aislamiento térmico mediante revestimiento de lana de roca - puertas con cristal de inspección pyrex - iluminación interna - 2 termostatos para cada cámara.
- RU Профессиональные электрические печи для выпечки пиццы, фокаччи и т.д. Нержавеющая сталь или покрытие спереди - огнеупорная варочная поверхность - теплоизоляция с помощью покрытия из минеральной ваты - двери с закаленным смотровым стеклом - внутреннее освещение - по 2 термостата для каждой камеры.



FES44

	FYL4	FYL44	FYL6	FYL66	FES4	FES44
	6 kW (1 Ph - 27A) (3 Ph - 9A)	12 kW (1 Ph - 54A) (3 Ph - 18A)	9 kW (1 Ph - 36A) (3 Ph - 12A)	18 kW (1 Ph - 72A) (3 Ph - 24A)	4,2 kW (1 Ph - 20A) (3 Ph - 7A)	8,4 kW (1 Ph - 40A) (3 Ph - 15A)
	230-400V/3N/50-60Hz					
	230V/1N/50-60Hz					
	50±500°C					
	720 x 720 x 140(h) mm	720 x 720 x 140(h) mm x2	720 x 1080 x 140(h) mm	720 x 1080 x 140(h) mm x2	660 x 660 x 140(h) mm	660 x 660 x 140(h) mm x2
	1010 x 850 x 420(h) mm	1010 x 850 x 750(h) mm	1010 x 1210 x 420(h) mm	1010 x 1210 x 750(h) mm	900 x 785 x 420(h) mm	900 x 785 x 750(h) mm
						
	86 Kg	146 Kg	116 Kg	200 Kg	73 Kg	123 Kg
	108 Kg	173 Kg	143 Kg	231 Kg	85 Kg	136 Kg
	1090 x 1040 x 570(h) mm	1090 x 1040 x 920(h) mm	1090 x 1400 x 570(h) mm	1090 x 1400 x 920(h) mm	990 x 960 x 580(h) mm	990 x 960 x 930(h) mm
	0,657 m³	1,032 m³	0,885 m³	1,389 m³	0,551 m³	0,883 m³

Special Voltages - Разное питающее напряжение

	FES6	FES66
	7,2 kW (1 Ph - 30A) (3 Ph - 10A)	14,4 kW (1 Ph - 63A) (3 Ph - 21A)
	230-400V/3N/50-60Hz	
	230V/1N/50-60Hz	
	50÷500°C	
	660 x 995 x140(h) mm	660 x 995 x 140(h) mm x2
	900 x 1080 x 420(h) mm	900 x 1080 x 750(h) mm
		
	93 Kg	159 Kg
	106 Kg	174 Kg
	1200 x 960 x 580(h) mm	1200 x 960 x 930(h) mm
	0,668 m³	1,071 m³

Special Voltages - Разное питающее напряжение



MICROV1C-MICRO1C MICROV2C-MICRO2C MINI



MICROV1C



MICROV2C



MICRO1C



MICRO2C

Forni pizza elettrici

ELECTRIC PIZZA OVENS
FOURS À PIZZA ÉLECTRIQUES
ELEKTRISCHE PIZZAÖFEN
HORNOS ELÉCTRICOS PARA PIZZA
ЭЛЕКТРИЧЕСКИЕ ПЕЧИ ДЛЯ ПИЦЦЫ

IT Forno elettrico professionale per la cottura di pizza, focacce, ecc. Rivestimento frontale inox - piano di cottura refrattario - isolamento termico mediante rivestimento in lana di roccia - 3 termostati per modello MINI - 2 termostati per modello MICROV1C-MICRO1C - 4 termostati per modello MICROV2C - MICRO2C.

MICROV1C-MICROV2C: porte con vetro di ispezione in pirex.
MICRO1C-MICRO2C-MINI: porta cieca.

EN Professional electric ovens for baking pizza, focaccia, etc. Stainless steel front covering - refractory cooking surface - thermal insulation by means of rock wool coating - 3 thermostats on mod. MINI - 2 thermostats on mod. MICROV1C - MICRO1C - 4 thermostats for mod. MICROV2C-MICRO2C. MICROV1C-MICROV2C: doors with pyrex inspection glass. MICRO1C-MICRO2C-MINI: blind door.

FR Fours électriques professionnels pour la cuisson de pizzas, focaccia, etc. revêtement frontal en acier Inox - plaque de cuisson réfractaire - isolation thermique par laine de roche - 3 thermostats pour le mod. MINI, 2 thermostats pour le mod. MICROV1C-MICRO1C - 4 thermostats pour le mod. MICROV2C-MICRO2C.

MICROV1C-MICROV2C: portes avec vitre d'inspection en pyrex.
MICRO1C-MICRO2C-MINI: porte non vitrée.













DE Professionelle Elektrobacköfen zum Backen von Pizza, Focaccia, usw. Edelstahl-Frontblende - hitzebeständige Kochfläche - Wärmedämmung durch Steinwollebeschichtung - 3 Thermostate im Mod. MINI - 2 Thermostate bei Mod. MICROV1C - MICRO1C - 4 Thermostate für Mod. MICROV2C-MICRO2C. MICROV1C-MICROV2C: Türen mit Pyrex-Schauglas. MICRO1C-MICRO2C-MINI: Blindertür

ES Hornos eléctricos profesionales para hornear pizza, focaccia, etc. Revestimiento frontal de acero inoxidable - superficie de cocción refractaria - aislamiento térmico mediante revestimiento de lana de roca - 3 termostatos en el mod. MINI - 2 termostatos en el mod. MICROV1C-MICRO1C - 4 termostatos para mod. MICROV2C-MICRO2C.

MICROV1C-MICROV2C: puertas con cristal de inspección pyrex.
MICRO1C-MICRO2C-MINI: puerta ciega.

RU Профессиональные электрические печи для выпечки пиццы, фокаччи и др. Облицовка из нержавеющей стали - огнеупорная варочная поверхность - теплоизоляция с помощью покрытия из минеральной ваты - 3 термостата на мод. MINI - 2 термостата на мод. MICROV1C - MICRO1C - 4 термостата для мод. MICROV2C-MICRO2C. MICROV1C-MICROV2C: двери с закаленным смотровым стеклом.

MICRO1C-MICRO2C-MINI: слепая дверь.

	MICROV1C	MICRO1C	MICROV2C	MICRO2C	MINI
					
	2,2 kW (1 Ph - 9,5A)		4,4 kW (1 Ph - 19A) (3 Ph - 9,6A)		6 kW (1 Ph - 27A) (3 Ph - 9A)
	-		230-400V/3N/50-60Hz		
	230V/1N/50-60Hz				
	50±500°C				
	405 x 405 x 110(h) mm		405 x 405 x 110(h) mm x2		500 x 500 x 110(h) mm x2
	555 x 460 x 290(h) mm		555 x 460 x 530(h) mm		780 x 600 x 530(h) mm
					
	27 Kg		54 Kg		66 Kg
	35 Kg		63 Kg		79 Kg
	620 x 620 x 450(h) mm		620 x 620 x 690(h) mm		850 x 820 x 690(h) mm
	0,173 m³		0,265 m³		0,481 m³

Special Voltages - Разное питающее напряжение



MINI

MICROV18C
MICROV22C



MICROV18C



MICROV22C

Forni pizza elettrici

ELECTRIC PIZZA OVENS
FOURS À PIZZA ÉLECTRIQUES
ELEKTRISCHE PIZZAÖFEN
HORNOS ELÉCTRICOS PARA PIZZA
ЭЛЕКТРИЧЕСКИЕ ПЕЧИ ДЛЯ ПИЦЦЫ

- IT** Forni elettrici professionali per la cottura di pizza, focacce, ecc.
Rivestimento frontale inox - piano di cottura refrattario - isolamento termico mediante rivestimento in lana di roccia - 2 termostati - porte con vetro di ispezione in pirex. Camera di altezza 18 cm per il modello MICROV18C e 22 cm per il modello MICROV22C che è dotato di luce e pirometro.
- EN** Professional electric ovens for baking pizza, focaccia, etc.
Stainless steel front covering - refractory cooking surface - thermal insulation by means of rock wool coating - 2 thermostats - doors with pyrex inspection glass. Chamber height 18 cm on MICROV18C and height 22 cm on mod. MICROV22C also equipped with light and pyrometer.
- FR** Fours électriques professionnels pour la cuisson de pizzas, focaccia, etc.
Revêtement frontal en acier Inox - surface de cuisson réfractaire - isolation thermique par revêtement en laine de roche - 2 thermostats - portes avec vitre en pyrex. Hauteur de la chambre 18 cm sur le modèle MICROV18C et hauteur 22 cm sur le modèle MICROV22C équipé aussi de lumière et pyromètre.
- DE** Professionelle Elektrobacköfen zum Backen von Pizza, Focaccia, usw.
Edelstahl-Frontblende - feuerfeste Kochfläche - Wärmedämmung durch Steinwollebeschichtung - 2 Thermostate - Türen mit Pyrex-Schauglas. Kammerhöhe 18 cm bei Modell MICROV18C und Höhe 22 cm bei Modell MICROV22C auch mit Licht und Pyrometer.
- ES** Hornos eléctricos profesionales para hornear pizza, focaccia, etc.
Revestimiento frontal de acero inoxidable - superficie de cocción refractaria - aislamiento térmico mediante revestimiento de lana de roca - 2 termostatos - puertas con cristal de inspección pyrex. Altura de cámara 18 cm en el modelo MICROV18C y 22 cm en el modelo MICROV22C equipado con luz y pirómetro.
- RU** Профессиональные электрические печи для выпечки пиццы, фокачки и т.д. Облицовка из нержавеющей стали - огнеупорная варочная поверхность - теплоизоляция с помощью покрытия из минеральной ваты - 2 термостата - двери с закаленным смотровым стеклом. Высота камеры 18 см у модели MICROV18C и 22 см у модели MICROV22C, оснащенной подсветкой и пирометром.

	MICROV18C	MICROV22C
	2,2 kW (1 Ph - 9,5A)	
 1 Ph	230V/1N/50-60Hz	
	50÷500°C	
	405 x 405 x 180(h) mm	405 x 405 x 220(h) mm
 mm	555 x 460 x 360(h) mm	600 x 560 x 400(h) mm
		
 NET Kg	29 Kg	33 Kg
 GROSS Kg	34 Kg	40 Kg
 mm	610 x 610 x 500(h) mm	630 x 610 x 540(h) mm
 m ³	0,186 m ³	0,208 m ³

Special Voltages - Разное питающее напряжение

FP









FP

Fornetto per pizza

PIZZA OVEN
FOUR À PIZZA
PIZZAOFEN
HORNO PARA PIZZA
ПЕЧКА ДЛЯ ПИЦЦЫ

- IT Forno per riscaldare pizze, panini, cibi precotti, toast farciti, piadine, ecc. Struttura in acciaio inox - griglia estraibile con manico pieghevole - termostato 50÷300°C - timer 0÷15 minuti - cassetto raccolta residui di cottura.
- EN Small oven for heating pizzas, sandwiches, pre-cooked food, stuffed toast, piadinas, etc.. Stainless steel casing - extractable grill with folding handle - thermostat 50÷300°C - timer 0÷15 minutes - drawer for collecting cooking waste.
- FR Petit four pour réchauffer pizzas, sandwiches, aliments pré-cuits, toasts farcis, piadinas, etc. Corps en acier Inox - grille extractible avec poignée escamotable - thermostat 50÷300°C - minuterie 0÷15 minutes - tiroir de récolte des résidus de cuisson.
- DE Tishofen zum Erwärmen von Pizza, Sandwiches, vorgekochten Speisen, gefülltem Toast, Piadinas, usw. Edelstahlgehäuse - herausnehmbarer Gitterrost mit Faltgriff - Thermostat 50÷300°C - Timer 0÷15 Minuten - Kchrückständen Sammelfach.
- ES Hornillo para calentar pizzas, bocadillos, comida precocinada, tostadas rellenas, piadinas, etc. Estructura de acero inoxidable - parrilla extraíble con mango plegable - termostato 50÷300°C - temporizador 0÷15 minutos - cajón para recoger los residuos de la cocción.
- RU Печь для разогревания пиццы, бутербродов, пищевых полуфабрикатов, сэндвичей, лепешек и т.п. Корпус из нержавеющей стали, выдвижная решетка со складной ручкой, термостат 50÷300°C - таймер 0÷15 минут, поддон для сбора отходов.

	FP
	1,75 kW
 1 Ph	230V/1N/50-60Hz
	50÷300°C
	Meccanico - Mechanical - Механический 0÷15'
	300 x 330 x 50(h) mm
	500 x 400 x 210(h) mm
	
 NET Kg	14 Kg
 GROSS Kg	16 Kg
 mm	580 x 500 x 290(h) mm
 m ³	0,084 m ³

Special Voltages - Разное питающее напряжение

FGI4-FGI6-FGI9



FGI6

Forni pizza a gas

RSP01	RSP02
Raccordo per sovrapposizione forni a gas - Overlap connection gas ovens - Raccord à superposition pour fours à gaz Anschluss für die Übereinanderstellung von Gasöfen Superposición para hornos a gas - Наложение для газовых плит	
Mod. FGI4	Mod. FGI6 - FGI9



RSP01

RAV01	RAV02
Raccordo antivento per forni a gas - Windproof connection for gas ovens - Raccord coupe-vent pour fours à gaz Winddichte Verbindung für Gasöfen Conexión cortaviento para hornos a gas Муфта для защиты от ветра для газовых плит	
Mod. FGI4	Mod. FGI6 - FGI9



RAV01

GAS PIZZA OVENS
FOURS À PIZZA À GAZ
GAS PIZZAÖFEN
HORNOS A GAS PARA PIZZA
ПЕЧИ ДЛЯ ПИЦЦЫ

IT Forni a gas professionali per la cottura di pizza, focacce, ecc.
 Rivestimento frontale inox - piano di cottura refrattario - isolamento termico mediante rivestimento in lana di roccia - porte con vetro di ispezione in pirex - accensione con piezoelettrico - alimentazione a metano, in dotazione kit G.P.L - illuminazione interna - termostato digitale - allacciamento gas 3/4"G. Accessori: Raccordo antivento per migliorare la combustione - raccordo sovrapposizione 2 forni.

















EN Professional gas ovens for baking pizza, focaccia, etc.
 Stainless steel front covering - refractory cooking surface - thermal insulation by means of rock wool coating - doors with pyrex inspection glass - piezoelectric ignition - natural gas supply, supplied with LPG set - internal lighting - digital thermostat - 3/4 "G gas connection.
 Accessories: windproof connection to improve combustion - overlap connection for 2 ovens.

FR Fours à gaz professionnels pour la cuisson de pizzas, focaccia, etc.
 Revêtement frontal en acier Inox - surface de cuisson réfractaire - isolation thermique par revêtement en laine de roche - portes avec vitre d'inspection en pyrex - allumage piézoélectrique - alimentation gaz naturel, fournie avec kit GPL - éclairage intérieur - thermostat numérique - raccordement gaz 3/4" G. Accessoires: raccord coupe-vent pour améliorer la combustion - raccord à superposition pour 2 fours.

DE Professionelle Gasbacköfen zum Backen von Pizza, Focaccia, usw.
 Edelstahl-Frontblende - hitzebeständige Kochfläche - Wärmedämmung durch Steinwollebeschichtung - Türen mit Pyrex-Schauglas - piezoelektrische Zündung - Erdgasversorgung, geliefert mit LPG-Set - Innenbeleuchtung - digitaler Thermostat - 3/4 "G-Gasanschluss.
 Zubehör: winddichte Verbindung zur Verbesserung der Verbrennung - Stapelverbindung für 2 Öfen.

ES Hornos profesionales a gas para hornear pizza, focaccia, etc.
 Revestimiento frontal de acero inoxidable - superficie de cocción refractaria - aislamiento térmico mediante revestimiento de lana de roca - puertas con cristal de inspección pyrex - encendido piezoeléctrico - aprovisionamiento de gas natural, provisto con juego de GLP - iluminación interior - termostato digital - conexión de gas 3/4 "G".
 Accesorios: conexión cortaviento para mejorar la combustión - superposición para 2 hornos.





RU Профессиональные газовые печи для выпечки пиццы, лепешек и т.п..
 Фронтальная облицовка из нержавеющей стали, огнеупорная жарочная поверхность, теплоизоляционное покрытие из минеральной ваты, дверки со смотровыми окошками из стекла пирекс, пьезоэлектрическое зажигание, работа на метане, в комплекте с оснасткой для работы на сжиженном природном газе, внутренняя подсветка, цифровой термостат.
 Комплектующие: Соединение с защитой против ветра для улучшения сгорания - соединение для вертикального размещения 2 печей.

	FGI4	FGI6	FGI9
	13,9 kW	18 kW	24,5 kW
 1 Ph	230V/1N/50-60Hz		
	50÷450°C		
	Digitale - Digital - Цифровой		
 kcal/h BTU/h	11.954 kcal/h 47.437 BTU/h	15.480 kcal/h 61.429 BTU/h	21.070 kcal/h 83.611 BTU/h
 METANO METHANE METAHA	G20 = 1,470 m³/h G25 = 1,710 m³/h	G20 = 1,904 m³/h G25 = 2,215 m³/h	G20 = 2,592 m³/h G25 = 3,015 m³/h
 GPL LPG	G30/G31 = 1,087 Kg/h	G30/G31 = 1,408 Kg/h	G30/G31 = 1,917 Kg/h
	N° 4 (Bruciatori - Burners - горелки)		N° 6 (Bruciatori - Burners - горелки)
	620 x 620 x 155(h) mm	620 x 920 x 155(h) mm	920 x 920 x 155(h) mm
 mm	1000 x 840 x 470(h) mm	1000 x 1140 x 470(h) mm	1300 x 1140 x 470(h) mm
			
 NET Kg	115 Kg	146 Kg	181 Kg
 GROSS Kg	131 Kg	163 Kg	201 Kg
 mm	1090 x 1040 x 640(h) mm	1070 x 1340 x 640(h) mm	1370 x 1340 x 640(h) mm
 m³	0,73 m³	0,92m³	1,17 m³

Cavalletti

per forni pizza

STAND FOR PIZZA OVENS
SUPPORT PUOR FOUR À PIZZA
PIZZAOFEN-GESTELL
CABALLETE PARA HORNOS PARA PIZZA
ПЕЧЬ ДЛЯ ПИЦЦЫ МОЛЬБЕРТ

					
CAVFOFMD4	1010 x 850 x 980(h) mm	39 Kg	40 Kg	1020 x 860 x 130(h) mm	0,114 m³
CAVFOFMD44	1010 x 850 x 850(h) mm				
CAVFOFMD6	1010 x 1210 x 980(h) mm	48 Kg	49 Kg	1020 x 1220 x 130(h) mm	0,162 m³
CAVFOFMD66	1010 x 1210 x 850(h) mm				
CAVFOFMDW6	1370 x 850 x 980(h) mm	45 Kg	46 Kg	1380 x 860 x 130(h) mm	0,154 m³
CAVFOFMDW66	1370 x 850 x 850(h) mm				
CAVFOFMD9	1370 x 1210 x 980(h) mm	63 Kg	64 Kg	1380 x 1220 x 130(h) mm	0,219 m³
CAVFOFMD99	1370 x 1210 x 850(h) mm				
CAVFOFML4	1010 x 850 x 980(h) mm	39 Kg	40 Kg	1020 x 860 x 130(h) mm	0,114 m³
CAVFOFML44	1010 x 850 x 850(h) mm				
CAVFOFML6	1010 x 1210 x 980(h) mm	48 Kg	49 Kg	1020 x 1220 x 130(h) mm	0,162 m³
CAVFOFML66	1010 x 1210 x 850(h) mm				
CAVFOFMLW6	1370 x 850 x 980(h) mm	45 Kg	46 Kg	1380 x 860 x 130(h) mm	0,154 m³
CAVFOFMLW66	1370 x 850 x 850(h) mm				
CAVFOFML9	1370 x 1210 x 980(h) mm	63 Kg	64 Kg	1380 x 1220 x 130(h) mm	0,219 m³
CAVFOFML99	1370 x 1210 x 850(h) mm				
CAVFOFME4	900 x 735 x 980(h) mm	30 Kg	31 Kg	910 x 750 x 130(h) mm	0,088 m³
CAVFOFME44	900 x 735 x 850(h) mm				
CAVFOFME6	900 x 1020 x 980(h) mm	38 Kg	39 Kg	910 x 1030 x 130(h) mm	0,122 m³
CAVFOFME66	900 x 1020 x 850(h) mm				
CAVFOFMEW6	1150 x 735 x 980(h) mm	39 Kg	40 Kg	1160 x 750 x 130(h) mm	0,113 m³
CAVFOFMEW66	1150 x 735 x 850(h) mm				

					
CAVFOFME9	1150 x 1020 x 980(h) mm	47Kg	48 Kg	1160 x 1030 x 130(h) mm	0,155 m³
CAVFOFME99	1150 x 1020 x 850(h) mm				
CAVFOFYL4	1010 x 850 x 980(h) mm	39 Kg	40 Kg	1020 x 860 x 130(h) mm	0,114 m³
CAVFOFYL44	1010 x 850 x 850(h) mm				
CAVFOFYL6	1010 x 1210 x 980(h) mm	48 Kg	49 Kg	1020 x 1220 x 130(h) mm	0,162 m³
CAVFOFYL66	1010 x 1210 x 850(h) mm				
CAVFOFES4	900 x 785 x 980(h) mm	33 Kg	34 Kg	740 x 890 x 130(h) mm	0,085 m³
CAVFOFES44	900 x 785 x 850(h) mm	31 Kg	32 Kg		
CAVFOFES6	900 x 1080 x 980(h) mm	41 Kg	42 Kg	1020 x 890 x 130(h) mm	0,118 m³
CAVFOFES66	900 x 1080 x 850(h) mm	39 Kg	40 Kg		
CAVFOFINI	780 x 600 x 980(h) mm	26 Kg	27 Kg	790 x 610 x 130(h) mm	0,063 m³
CAVFOFGI4 CAVFOFGI44	1000 x 840 x 1000(h) mm	34 Kg	35 Kg	1020 x 770 x 130(h) mm	0,102 m³
CAVFOFGI6 CAVFOFGI66	1000 x 1140 x 1000(h) mm	42 Kg	43 Kg	1020 x 1070 x 130(h) mm	0,142 m³
CAVFOFGI9 CAVFOFGI99	1300 x 1140 x 1000(h) mm	52 Kg	53 Kg	1310 x 1070 x 130(h) mm	0,182 m³



AV4938/67/39



IT Contenitore per impasti pizza

EN Pizza dough container

FR Conteneur pour pâte à pizza

DE Pizzateigbehälter



	AV4938	AV4967	AV4939 Coperchio/Cover
	600 x 400 x 75(h) mm	600 x 400 x 90(h) mm	600 x 400 mm

Scopri tutti gli optional su Forcar Multiservice!
Discover Forcar Multiservice!

CL
FML-FMLW-FYL
FMD-FMDW-FME-FES
MINI-FGI4-FGI6-FGI9



Celle di lievitazione per forni pizza

PROVING CELLS FOR PIZZA OVENS
CELLULES DE FERMENTATION
CONTROLÉE POUR FOURS À PIZZA
GÄRZELLEN FÜR PIZZAÖFEN
CÉLULAS DE FERMENTACIÓN PARA HORNOS DE PIZZA
ЯЧЕЙКИ РАССТРОЕЧНЫЕ ПЕЧЕЙ ДЛЯ ПИЦЦЫ

IT Celle di lievitazione per forni pizza, in lamiera verniciata di nero complete di riscaldatore. Le celle sono utilizzabili come supporti per i forni in alternativa ai cavalletti.
Accessori: porta teglie e kit ruote.











EN Proving cells for pizza ovens in black coated metal plate including heating unit. The cells can be used as oven supports in alternative to stands.
Accessories: tray rack and wheel set.

FR Cellules de levage pour fours à pizza en tôle peinte en noir, avec chauffage. Les cellules peuvent être utilisées comme supports de four en alternative aux supports.
Accessoires: porte plaques et jeu de roues.

DE Gärzellen für Pizzaöfen aus schwarz beschichteter Metallplatte inklusive Heizeinheit. Die Zellen können als Backofenstützen alternativ zum Gestell verwendet werden.
Zubehör: Blechträger und Rädersatz.











ES Células de fermentación para hornos de pizza en chapa negra con unidad de calentamiento incluida. Las celdas se pueden utilizar como soportes de horno en lugar de los caballetes.
Accesorios: porta bandejas y juego de ruedas.

RU Ячейки расстрочные для печей для пиццы из нержавеющей стали, окрашенной в черный цвет. Используются как опоры для печей в качестве альтернативных подставок.
Комплектующие: держатель противней - комплект колес.

	CL FML-FYL-FMD 4	CL FML-FYL-FMD 44	CL FML-FYL-FMD 6	CL FMLW-FMDW 6	CL FML-FYL-FMD 66	CL FMLW-FMDW 66	CL FML-FMD 9	CL FML-FMD 99
	1,1 kW							
 1 Ph	230V/1N/50-60Hz							
	Max. 90°C							
	9* 11**	7* 9**	9* 11**		7* 9**		9* 11**	7* 9**
	1010 x 855 x 980(h) mm	1010 x 855 x 850(h) mm	1010 x 1215 x 980(h) mm	1370 x 855 x 980(h) mm	1010 x 1215 x 850(h) mm	1370 x 855 x 850(h) mm	1370 x 1215 x 980(h) mm	1370 x 1215 x 850(h) mm
								
 NET Kg	69 Kg* 72 Kg**	64 Kg* 65 Kg**	85 Kg* 90 Kg**	84 Kg* 89 Kg**	78 Kg* 81 Kg**	77 Kg* 80 Kg**	104 Kg* 110 Kg**	96 Kg* 100 Kg**
 GROSS Kg	85 Kg* 88 Kg**	80 Kg* 81 Kg**	103 Kg* 108 Kg**	102 Kg* 107 Kg**	96 Kg* 99 Kg**	95 Kg* 98 Kg**	127 Kg* 133 Kg**	119 Kg* 123 Kg**
 mm	1090 x 1040 x 1130(h) mm	1090 x 1040 x 980(h) mm	1400 x 1090 x 1130(h) mm		1400 x 1090 x 980(h) mm		1400 x 1400 x 1130(h) mm	1400 x 1400 x 980(h) mm
 m³	1,280 m³	1,140 m³	1,720 m³		1,500 m³		2,210 m³	1,920 m³

* Con ruote / With wheels
Avec roues / Mit Rädern
Con ruedas / С колесами











** Senza ruote / Without wheels
Sans roues / Ohne Räder
Sin ruedas / Без колес

	CL FME 4	CL FME 44	CL FME 6	CL FMEW 6	CL FME 66	CL FMEW 66	CL FME 9	CL FME 99
	1,1 kW							
	230V/1N/50-60Hz							
	Max. 90°C							
	9* 11**	7* 9**	9* 11**		7* 9**		9* 11**	7* 9**
	900 x 740 x 980(h) mm	900 x 740 x 850(h) mm	900 x 1025 x 980(h) mm	1150 x 740 x 980(h) mm	900 x 1025 x 850(h) mm	1150 x 740 x 850(h) mm	1150 x 1025 x 980(h) mm	1150 x 1025 x 850(h) mm
								
	60 Kg* 62 Kg**	55 Kg* 56 Kg**	71 Kg* 75 Kg**	69 Kg* 73 Kg**	63 Kg* 67 Kg**	62 Kg* 65 Kg**	82 Kg* 88 Kg**	74 Kg* 78 Kg**
	74 Kg* 76 Kg**	69 Kg* 70 Kg**	87 Kg* 91 Kg**	85 Kg* 89 Kg**	79 Kg* 83 Kg**	78 Kg* 81 Kg**	105 Kg* 111 Kg**	97 Kg* 101 Kg**
	990 x 960 x 1130(h) mm	990 x 960 x 980(h) mm	1200 x 960 x 1130(h) mm		1200 x 960 x 980(h) mm		1200 x 1200 x 1130(h) mm	1200 x 1200 x 980(h) mm
	1,070 m³	0,930 m³	1,300 m³		1,130 m³		1,630 m³	1,410 m³

	ACGPCL	ACGPCLM
	Porta teglie - Tray rack - Porte plaques - Blechräger - Porta bandejas - Держатель противней	
	400 x 600 mm	400 x 500 mm
Mod.	CL FML - FMLW - FYL - FMD - FMDW FME - FMEW - FES - FGI	CL MINI

* Con ruote / With wheels
Avec roues / Mit Rädern
Con ruedas / С колесами

** Senza ruote / Without wheels
Sans roues / Ohne Räder
Sin ruedas / Без колес

	CL FES 4	CL FES 44	CL FES 6	CL FES 66	CL MINI	CL FGI 4	CL FGI 6	CL FGI 9
	1,1 kW							
	230V/1N/50-60Hz							
	Max. 90°C							
	9* 11**	7* 9**	9* 11**	7* 9**	9* 11**			
	900 x 790 x 980(h) mm	900 x 790 x 850(h) mm	900 x 1085 x 980(h) mm	900 x 1085 x 850(h) mm	780 x 605 x 980(h) mm	1000 x 845 x 1000(h) mm	1000 x 1145 x 1000(h) mm	1300 x 1145 x 1000(h) mm
								
	62 Kg* 64 Kg**	57 Kg* 58 Kg**	73 Kg* 77 Kg**	65 Kg* 69 Kg**	50 Kg* 52 Kg**	67 Kg* 70 Kg**	79 Kg* 83 Kg**	91 Kg* 96 Kg**
	76 Kg* 78 Kg**	71 Kg* 72 Kg**	89 Kg* 93 Kg**	81 Kg* 85 Kg**	60 Kg* 62 Kg**	83 Kg* 86 Kg**	96 Kg* 100 Kg**	111 Kg* 116 Kg**
	990 x 960 x 1130(h) mm	990 x 960 x 980(h) mm	1200 x 960 x 1130(h) mm	1200 x 960 x 980(h) mm	850 x 810 x 980(h) mm	1090 x 1040 x 1130(h) mm	1340 x 1070 x 1130(h) mm	1370 x 1340 x 1130(h) mm
	1,073 m³	0,931 m³	1,301 m³	1,128 m³	0,670 m³	1,280 m³	1,620 m³	2,070 m³

ACRCL

Kit ruote per cella - Wheel set - Jeu de roues - Rädersatz - Grupo de ruedas para celda - Набор колёс
(da aggiungere al momento dell'ordine della cella to be added when ordering the cell)

Mod.

CL FML - FMLW - FYL - FMD - FMDW - FME - FMEW - FES - FGI

* Con ruote / With wheels
Avec roues / Mit Rädern
Con ruedas / С колесами

** Senza ruote / Without wheels
Sans roues / Ohne Räder
Sin ruedas / Без колес

CAPPA FML-FMLW-FYL FMD-FMDW-FME-FMEW



FORNO CON CAPPA ASPIRANTE CON FILTRO A CARBONI ATTIVI
OVEN WITH ACTIVE CARBON FILTER COOKER HOOD



FORNO CON CAPPA ASPIRANTE
OVEN WITH COOKER HOOD



FILTRO A CARBONI ATTIVI
ACTIVE CARBON FILTER

Cappe aspiranti
forni pizza

HOODS FOR PIZZA OVENS
HOTTES POUR FOURS À PIZZA
DUNSTABZUGSHAUBEN FÜR PIZZAÖFEN
CAMPANAS EXTRACTORAS PARA HORNOS DE PIZZA
ВЫТЯЖНЫЕ КОЛПАКИ ДЛЯ ПЕЧЕЙ ДЛЯ ПИЦЦЫ

IT Le cappe aspiranti sono disponibili per tutti i modelli di forni elettrici (esclusi modelli MICRO, MINI e FES). Di facile installazione, prevedono una motorizzazione con tre velocità di aspirazione. Grazie all'accessorio filtro con carbone attivo è possibile utilizzarla anche senza collegarla alla canna fumaria.









EN Oven cooker hoods are available for all models of electric ovens (except for the series MICRO, MINI and FES). Easy to install, they are provided with a three speeds suction motor. Thanks to the active carbon filter, it is possible to use them without being connected to the chimney flue.

FR Les hottes aspirantes sont disponibles pour tous les modèles de fours électriques (à l'exception des séries MICRO, MINI et FES). Faciles à installer, elles sont dotées d'une motorisation à trois vitesses d'aspiration. Grâce au filtre accessoire à charbon actif, il est possible de l'utiliser sans la raccorder au conduit de la cheminée.

DE Die Dunstabzugshauben sind für alle Elektrobacköfen (ausgenommen Serie MICRO, MINI und FES) verfügbar. Sie sind einfach zu installieren und bieten einen Motor mit drei Absaugstärken. Dank des eingebauten Aktivkohle-Filters können sie auch ohne Anschluss an den Kamin verwendet werden.

ES Las campanas aspiradoras son disponibles para todos los modelos de hornos eléctricos (excepto serie MICRO, MINI y FES). De fácil instalación, tienen una motorización de tres velocidades de aspiración. Gracias al complemento filtro con carbón activo es posible utilizarlas también sin conectarlas al tubo de la chimenea.

RU Вытяжные колпаки имеются в наличии для всех моделей электрических печей (кроме серий MICRO, MINI и FES), Легко устанавливаются, возможны 3 скорости всасывания. Благодаря дополнительному фильтру из активированного угля, наши вытяжные колпаки не нуждаются в соединении с дымоходом.

	CAPPA FML-FYL-FMD 4/44	CAPPA FML-FYL-FMD 6/66	CAPPA FML-FYL-FMD 9/99	CAPPA FMLW-FMDW 6/66	CAPPA FME 4/44	CAPPA FME 6/66	CAPPA FME 9/99	CAPPA FMEW 6/66
	0,31 kW							
 1 Ph	230V/1N/50Hz							
	1010 x 1085 x 240(h) mm	1010 x 1445 x 240(h) mm	1370 x 1445 x 240(h) mm	1370 x 1085 x 240(h) mm	900 x 970 x 240(h) mm	900 x 1255 x 240(h) mm	1150 x 1255 x 240(h) mm	1150 x 970 x 240(h) mm
								
 NET Kg	24 Kg	30 Kg	39 Kg	30 Kg	22 Kg	24 Kg	30 Kg	23 Kg
 GROSS Kg	26 Kg	32 Kg	41 Kg	32 Kg	24 Kg	26 Kg	32 Kg	25 Kg
 mm	1030 x 1100 x 250(h) mm	1390 x 1100 x 250(h) mm	1390 x 1460 x 250(h) mm	1390 x 1100 x 250(h) mm	920 x 980 x 250(h) mm	920 x 1060 x 250(h) mm	1170 x 1060 x 250(h) mm	1170 x 980 x 250(h) mm
 m ³	0,283 m ³	0,382 m ³	0,507 m ³	0,382 m ³	0,225 m ³	0,244 m ³	0,310 m ³	0,287 m ³

ACFILTRCAPPA

Filtro con carbone attivo - Active carbon filter - Filtre à charbon actif - Filter mit Aktivkohle - Filtro con carbón activo - Фильтр с активированным углем

RAPIDO

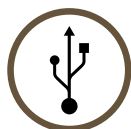

ENTRATA USB
USB INPUT



TOUCH SCREEN



VELOCE
FAST



GUARDA IL VIDEO
WATCH THE VIDEO



RAPIDO



Forno combinato
plug and cook

COMBI OVEN
FOUR COMBINÉ
KOMBI-DÄMPFER
HORNO COMBI
ΠΑΡΟΚΟΗΒΕΚΤΟΜΑΤ

Rapid-O

IT "Rapid-O" è un forno combinato che unisce la vaporizzazione dell'acqua ed un'elevata velocità dell'aria all'interno della camera di cottura - non ha bisogno di cappa o filtro - pronto all'uso. Struttura in acciaio inox - frontalino touch screen da 7 pollici - porta in vetro temperato - serbatoio da 3 L fino a 400 cicli di cottura - regolazione automatica di temperatura e livello di umidità in base all'effetto finale desiderato - 6 ricette precaricate e fino a 18 ricette memorizzabili - possibilità di tempo extra per prolungare il ciclo di cottura di 15 o 30 secondi - segnale di fine ciclo - teglia e pala per infornare incluse.











EN "Rapid-O" is a combi-oven that combines water steaming and high air flow rate inside the baking chamber - no hood or filter required - ready to use - plug and cook. Stainless steel construction - 7-inch touch screen front panel - tempered glass door - 3 L reservoir for up to 400 cooking cycles - automatic temperature and humidity level adjustment according to the desired final effect - 6 preloaded recipes and up to 18 recipes can be stored - possibility of extra time to extend the cooking cycle by 15 or 30 seconds - finish cycle signal - tray and baking shovel included.

FR "Rapid-O" est un four combiné qui utilise la vapeur d'eau et une grande vitesse d'air à l'intérieur de la chambre de cuisson. Il ne nécessite ni hotte ni filtre et est prêt à l'emploi - plug and cook (brancher et cuire). Construction en acier inox - panneau frontal à écran tactile de 7 pouces - porte en verre trempé - réservoir de 3 L pour 400 cycles de cuisson - réglage automatique de la température et du taux d'humidité en fonction de l'effet final souhaité - 6 recettes préchargées et possibilité de mémoriser jusqu'à 18 recettes - possibilité de temps supplémentaire pour prolonger le cycle de cuisson de 15 ou 30 secondes - signal de fin de cycle - plaque et palette de cuisson incluses.

DE "Rapid-O" ist ein Kombi-Dämpfer, der Wasserdampf und hohe Luftgeschwindigkeit in der Backkammer kombiniert - keine Haube oder Filter erforderlich - sofort einsatzbereit - mit Plug-and-Cook-Funktion. Gehäuse aus Edelstahl - 7-Zoll-Touchscreen auf der Vorderseite - Tür aus gehärtetem Glas - 3-Liter-Behälter für bis zu 400 Garvorgänge - automatische Einstellung von Temperatur und Luftfeuchtigkeit je nach gewünschtem Endergebnis - 6 vorinstallierte Rezepte und bis zu 18 speicherbare Rezepte - Möglichkeit der Verlängerung des Garvorgangs um 15 oder 30 Sekunden - Signal für das Ende des Garvorgangs - Bleche inbegriffen - inklusive Backschaufel.

ES "Rapid-O" es un horno combinado que combina la cocción al vapor del agua y la alta velocidad del aire en el interior de la cámara de cocción - sin necesidad de campana ni filtro - listo para usar - con función plug and cook. Construcción de acero inoxidable - panel frontal con pantalla táctil de 7 pulgadas - puerta de cristal templado - depósito de 3 L para hasta 400 ciclos de cocción - ajuste automático de la temperatura y el nivel de humedad según el efecto final deseado - 6 recetas precargadas y posibilidad de almacenar hasta 18 recetas - posibilidad de tiempo extra para ampliar el ciclo de cocción en 15 o 30 segundos - señal de ciclo finalizado - bandeja y la paleta de horneado incluida.

RU "Rapid-O" - это пароконвектомат, сочетающий в себе водяной пар и высокую скорость движения воздуха внутри рабочей камеры - не требуется вытяжка или фильтр - готов к использованию - с функцией "plug and cook". Конструкция из нержавеющей стали - 7-дюймовая сенсорная передняя панель - дверца из закаленного стекла - резервуар объемом 3 л для 400 циклов приготовления - автоматическая регулировка температуры и уровня влажности в зависимости от желаемого конечного эффекта - 6 предварительно загруженных рецептов и возможность сохранения до 18 рецептов - возможность дополнительного времени для продления цикла приготовления на 15 или 30 секунд - сигнал окончания цикла - Листы включены - лопатка для выпечки в комплекте.

RAPIDO	
	
	3,3 kW
 1 Ph	230V/1N/50-60Hz
	1x GN2/3 360 x 360 x 175(h) mm
	430 x 672 x 513(h) mm
	
 NET Kg	43 Kg
 GROSS Kg	52 Kg
 mm	500 x 760 x 670(h) mm
 m ³	0,255 m ³

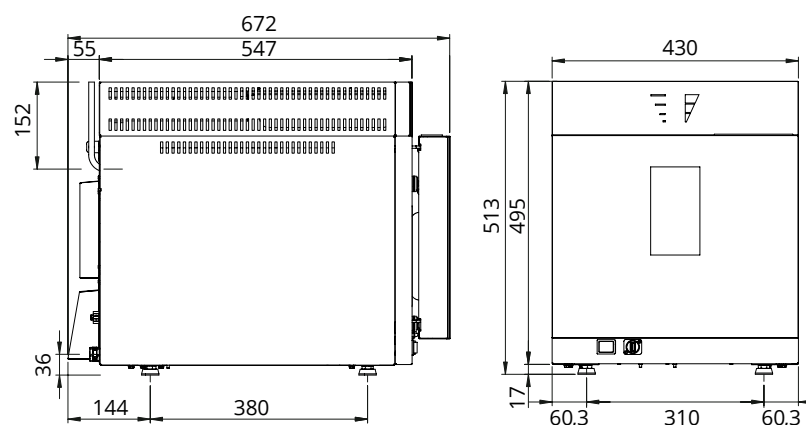

SLIM6D
SLIM623D

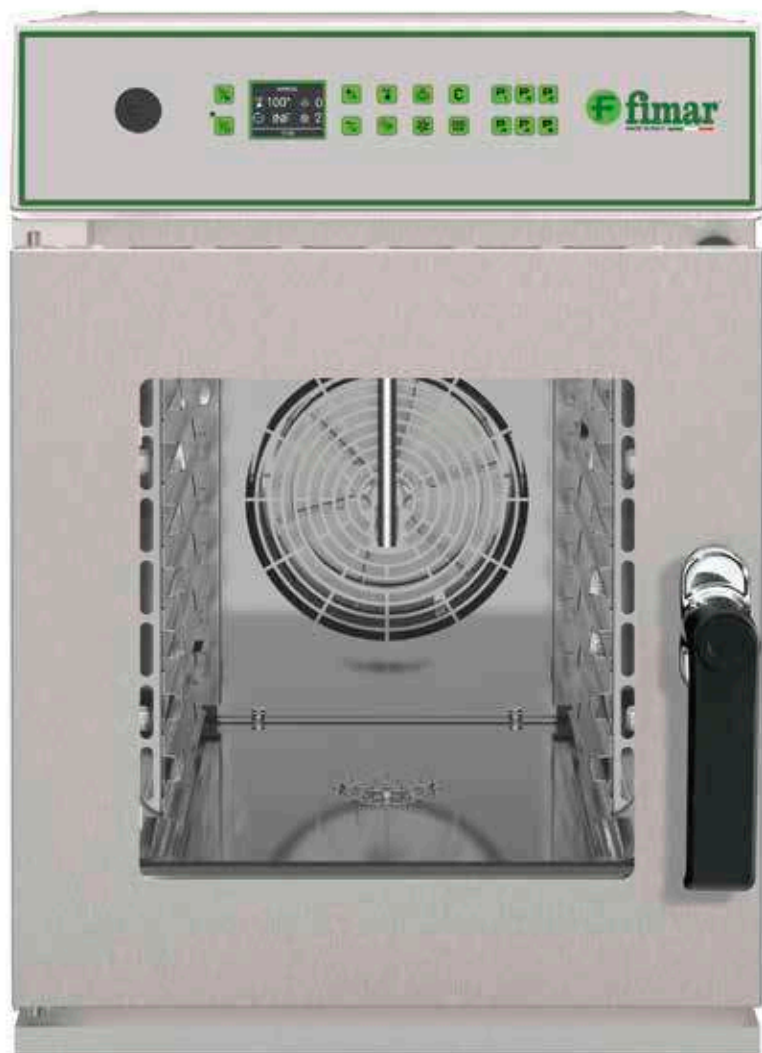

SLIM6D

Forni per gastronomia

convezione/vapore diretto digitali

GASTRONOMY OVENS DIGITAL
FOURS GASTRONOMIE NUMÉRIQUE
GASTRONOMIE-ÖFEN DIGITAL
HORNOS PARA GASTRONOMÍA DIGITALES
ГАСТРОНОМИЧЕСКИЕ ПЕЧИ ЦИФРОВЫЕ

IT Forni per gastronomia a convezione/vapore diretto. Struttura in acciaio inox - illuminazione interna a led - ventilatore centrifugo con autoreverse - porta con doppio vetro (vetro interno apribile) - scarico acqua - kit lavaggio interno incluso. Controllo digitale con 99 programmi - fino a 4 cicli di cottura in sequenza automatica per programma - preriscaldamento automatico - regolazione iniezione acqua digitale - sonda al cuore - regolazione ventole a 5 velocità - LCD da 2.4 pollici a colori - multi timer - connettività wifi e usb 2.0 per caricamento delle ricette.













EN Mixed convection/direct steam gastronomy ovens. Stainless steel casing - internal LED lamp - centrifugal fan with automatic reverse - double-glazed door (removable internal glass) - water drain -washing kit. Digital control with 99 programs - up to 4 cooking cycles in automatic sequence per program - automatic preheating - digital water injection regulation - core probe - 5-speed fan regulation - 2.4 inch colour LED -multi timer - Wi-Fi and usb 2.0 connection for uploading recipes.

FR Fours à convection et à vapeur directe pour la gastronomie. Corps en acier inox - éclairage interne à LED - ventilateur centrifuge avec inverseur automatique - porte avec double vitrage (possibilité d'ouvrir le verre interne) - évacuation de l'eau - kit de lavage inclus. Commande numérique avec 99 programmes - jusqu'à 4 cycles de cuisson en séquence automatique par programme - préchauffage automatique - régulation numérique de l'injection d'eau - sonde à cœur - régulation à 5 vitesses du ventilateur - LED couleur de 2,4 pouces - minuterie multiple - connectivité wifi et USB 2.0 pour télécharger des recettes.

DE Heißluft-/Direktdampfbacköfen für die Gastronomie. Edelstahlgehäuse - interne Ledbeleuchtung - Zentrifugalgebläse mit automatischer Wendefunktion - Tür mit Doppelverglasung (Innenglas kann geöffnet werden) - Wasserablauf - Wasch-Set. Digitale Steuerung mit 99 Programmen - bis zu 4 Kochzyklen in automatischer Abfolge pro Programm - automatische Vorwärmung - digitale Wassereinstellung - Kerntemperaturfühler - Lüftereinstellung mit 5 Stufen - 2,4-Zoll-LED-Farbdisplay - Multitimer - WiFi und USB-2.0-Anschluss zum Hochladen von Rezepten.

ES Hornos para gastronomía a convección/Vapor directo. Estructura de acero inoxidable - iluminación interior por LED - ventilador centrifugo con autorreversaciones - puerta con doble acristalamiento (se puede abrir el cristal interior) - drenaje de agua - kit de lavado incluido. Control digital con 99 programas - hasta 4 ciclos de cocción en secuencia automática por programa - precalentamiento automático - regulación de descarga de vapor - regulación digital de inyección de agua - sonda de corazón - regulación de ventilador de 5 velocidade - pantalla LCD en color de 2,4 pulgadas -multitemporizador - conectividad wifi y usb 2.0 para cargar recetas.

RU Конструкция из нержавеющей стали - светодиодное внутреннее освещение - центробежный вентилятор с автореверсированием - дверь с двойным остеклением (внутреннее стекло может быть открыто) - слив воды - комплект для внутренней промывки прилагается. Цифровое управление с 99 программами - до 4 циклов приготовления в автоматической последовательности в каждой программе - автоматический предварительный нагрев - регулирование выпуска пара - цифровое регулирование впрыска воды - датчик температуры сердечника - двухскоростное управление вентилятора - 2,4-дюймовый цветной ЖК-дисплей - мультитаймер - возможность подключения к Wi-Fi и usb 2.0 для загрузки рецептов.

	SLIM6D	SLIM623D
	6,3 kW	5,3 kW
	400V/3N/50-60Hz	
	230V/1N/50-60Hz	
	50±260°C	
	6 x GN1/1**	6 x GN2/3**
	380 x 563 x 376(h) mm	380 x 388 x 376(h) mm
	532 x 860/913 x 748(h) mm senza / con maniglia without / with handle	532 x 690/738 x 748(h) mm senza / con maniglia without / with handle
		
	72 Kg	63 Kg
	86 Kg	77 Kg
	600 x 1000 x 927(h) mm	
	0,560 m³	

** Teglie non incluse.
Trays not included.
Plaques pas incluses.
Bleche nicht inbegriffen.
Bandejas no incluidas.
Противни не входят в комплект.

SLIM6M
SLIM623M

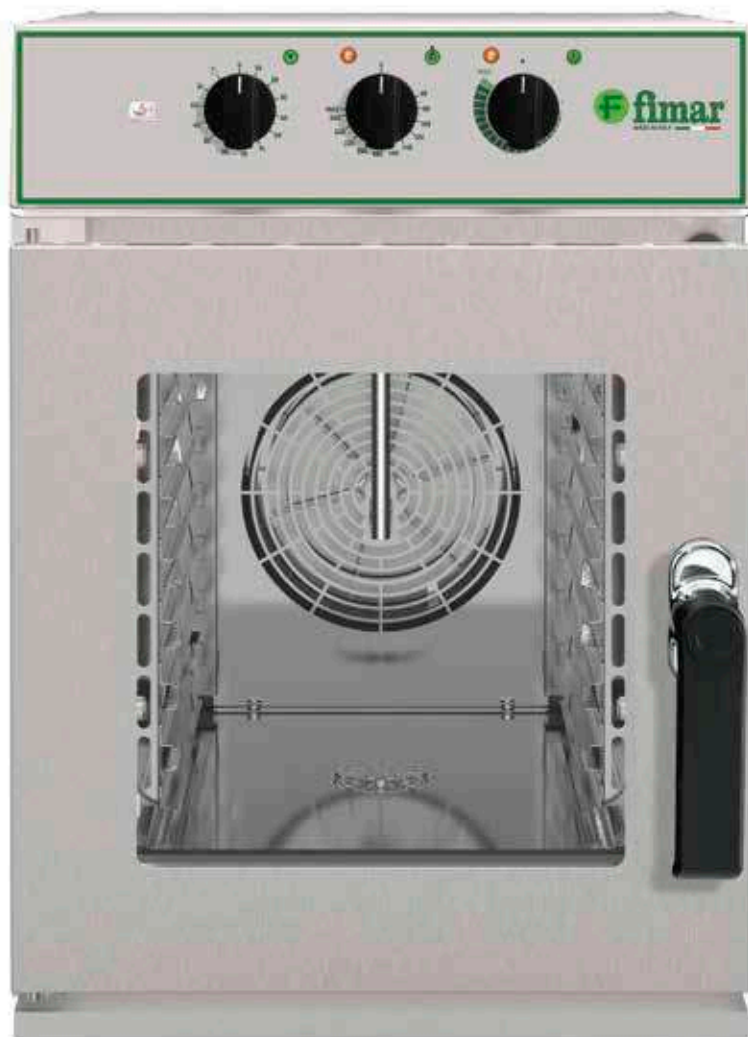













SLIM6M

Forni per gastronomia
convezione/vapore diretto meccanici

GASTRONOMY OVENS MECHANICAL
FOURS GASTRONOMIE MÉCANIQUES
GASTRONOMIE-ÖFEN MECHANISCH
HORNOS PARA GASTRONOMÍA MECÁNICO
ГАСТРОНОМИЧЕСКИЕ ПЕЧИ МЕХАНИЧЕСКИЕ

- IT** Forni per gastronomia a convezione/vapore diretto. Struttura in acciaio inox - illuminazione interna a LED - ventilatore centrifugo con autoreverse - porta con doppio vetro (vetro interno apribile) - scarico acqua - umidificatore con regolatore di energia (iniezione diretta).
- EN** Mixed convection/direct steam gastronomy ovens. Stainless steel casing - internal LED lamp - centrifugal fan with automatic reverse - double-glazed door (removable internal glass) - water drain - humidifier with energy regulator (direct injection).
- FR** Fours à convection et à vapeur directe pour la gastronomie. Corps en acier Inox - éclairage interne à LED - ventilateur centrifuge avec inverseur automatique - porte avec double vitrage (possibilité d'ouvrir le verre interne) - évacuation de l'eau - humidificateur avec régulateur d'énergie (injection directe).
- DE** Heißluft-/Direktdampfbacköfen für die Gastronomie. Edelstahlgehäuse - interne Ledbeleuchtung - Zentrifugalgebläse mit automatischer Wendefunktion - Tür mit Doppelverglasung (Innenglas kann geöffnet werden) - Wasserablauf - Befeuchter mit Energieregler (Direkteinspritzung).
- ES** Hornos para gastronomía a convección/vapor directo. Estructura de acero inoxidable - iluminación interior por LED - ventilador centrífugo con autorreversaciones - puerta con doble acristalamiento (se puede abrir el cristal interior) - drenaje de agua - humidificador con regulador de energía (inyección directa).
- RU** Конструкция из нержавеющей стали - светодиодное внутреннее освещение - центробежный вентилятор с автореверсированием - дверь с двойным остеклением (внутреннее стекло может быть открыто) - слив воды - увлажнитель с регулятором энергии (прямой впрыск).

	SLIM6M	SLIM623M
	6,3 kW	5,3 kW
	400V/3N/50-60Hz	
	230V/1N/50-60Hz	
	50±260°C	
	6 x GN1/1**	6 x GN2/3**
	380 x 563 x 376(h) mm	380 x 388 x 376(h) mm
	532 x 860/913 x 748(h) mm senza / con maniglia without / with handle	532 x 690/738 x 748(h) mm senza / con maniglia without / with handle
		
	72 Kg	63 Kg
	86 Kg	77 Kg
	600 x 1000 x 927(h) mm	
	0,560 m³	



** Teglie non incluse.
Trays not included.
Plaques pas incluses.
Bleche nicht inbegriffen.
Bandejas no incluidas.
Противни не входят в комплект.

TOP4TN
TOP6TN
TOP10TN



TOP4TN



TOP6TN



TOP10TN

** Teglie non incluse.
Trays not included.
Plaques pas incluses.
Bleche nicht inbegriffen.
Bandejas no incluidas.
Противни не входят в комплект.

Forni misti touch
convezione/vapore diretto GN1/1 60x40

MIXED OVENS WITH TOUCH CONTROLS
FOURS MIXTES À COMMANDES TACTILES
KOMBINIERTE "TOUCH" BACKÖFEN
HORNOS MIXTOS CONTROLLES TÁCTILES
ПЕЧИ СМЕШАННОГО ПРИГОТОВЛЕНИЯ С
СЕНСОРНЫМ УПРАВЛЕНИЕМ













IT Forni misti touch a convezione/vapore diretto. Struttura in acciaio inox - illuminazione interna a led - ventilatore centrifugo con autoreverse (2 ventole per il TOP4TN e per il TOP6TN, 3 ventole per il TOP10TN) - porta con doppio vetro (vetro interno apribile) - scarico acqua - kit lavaggio di serie - supporto universale per teglie GN1/1 o pasticceria 60x40 cm (teglie non incluse). Controllo touch con 120 programmi (20 ricette già registrate) - fino a 6 cicli di cottura in sequenza automatica per programma - preriscaldamento automatico - ventilatore fino a 2 velocità - regolatore del vapore - regolazione iniezione acqua digitale - sonda al cuore - gestione valvola di sfiato aperta / chiusa integrata - touch screen capacitivo da 5 pollici - connettività tramite USB 2.0.

EN Mixed convection/direct steam ovens with touch controls. Stainless steel casing - internal LED lamp - centrifugal fan with automatic reverse (2 on mod. TOP4TN and TOP6TN, 3 on mod TOP10TN) - double-glazed door (removable internal glass) - water drain -standard washing kit - universal holder for GN1/1 trays or 60x40 cm pastry trays (trays not included). Touch control with 120 programs (20 preset recipes) - up to 6 cooking cycles in automatic sequence per program - automatic preheating - double speed regulator - steam regulator - digital water injection regulation - core probe integrated open/closed air valve management - 5-inch capacitive touch screen - connectivity via USB 2.0.

FR Fours mixtes à convection et à vapeur directe avec commandes tactiles. Corps en acier Inox - éclairage interne à LED - ventilateur centrifuge avec inverseur automatique (2 pour TOP4TN et TOP6TN, 3 pour TOP10TN) - porte avec double vitrage (possibilité d'ouvrir le verre interne) - évacuation de l'eau - kit de lavage de série - support universel pour bacs GN1/1 ou bacs pâtisserie 60x40 cm (bacs non fournis). Commandes tactiles avec 120 programmes (20 recettes enregistrées)- jusqu'à 6 cycles de cuisson en séquence automatique par programme - préchauffage automatique - régulateur de double vitesse - régulateur de vapeur - régulation numérique de l'injection d'eau - sonde à cœur - gestion intégrée des vannes d'air ouvertes/fermées - écran tactile capacitif de 5 pouces - connectivité via USB 2.0.

DE Kombinierte Heißluft-/Direktdampfbacköfen mit Touch-Steuerung. Edelstahlgehäuse - interne Ledbeleuchtung - Zentrifugalgebläse mit automatischer Wendefunktion - (2 für TOP4TN und TOP6TN, 3 für TOP10TN) - Tür mit Doppelverglasung (Innenglas kann geöffnet werden) - Wasserablauf - Wasch-Set als Standard - Universalhalterung für GN1/1 Bleche oder 60x40 cm Konditoreibleche (Bleche nicht inbegriffen). Touch Steuerung mit 120 Programme (20 eingetragene Rezepte)- bis zu 6 Kochzyklen in automatischer Abfolge pro Programm - automatische Vorwärmung - Dampfaustrittseinstellung - digitale Wassereinspritzeneinstellung - Kerntemperaturfühler - integriertes Management des offenen/geschlossenen Luftventils - kapazitiver 5-Zoll-Touchscreen - USB 2. 0-Schnittstelle.

ES Hornos mixtos de convección/vapor directo. Estructura de acero inoxidable - iluminación interior por LED - ventilador centrifugo con autorreversaciones (2 para TOP4TN y TOP6TN, 3 para TOP10TN) - puerta con doble acristalamiento (se puede abrir el cristal interior) - drenaje de agua - kit de lavado estándar - soporte universal para bandejas GN1/1 o pastelería de 60x40 cm (bandejas no incluidas). Control táctil con 120 programas (20 recetas ya registradas) - hasta 6 ciclos de cocción en secuencia automática por programa - precalentamiento automático - regulación de descarga de vapor - regulación digital de inyección de agua - sonda de corazón - gestión integrada de válvulas de aire abiertas/cerradas - pantalla táctil capacitiva de 5 pulgadas - conectividad mediante USB 2.0.

	TOP4TN	TOP6TN	TOP10TN
	10,5 kW	12,7 kW	15,7 kW
	400V/3/50Hz		
	50±260°C		
	Digitale - Digital - Цифровой 0÷120'		
	4 x 600 x 400 mm** GN1/1 - P = 80 mm	6 x 600 x 400 mm** GN1/1 - P = 80 mm	10 x 600 x 400 mm** GN1/1 - P = 80 mm
	660 x 490 x 452(h) mm	660 x 490 x 612(h) mm	660 x 490 x 948(h) mm
	937 x 821/885 x 715(h) mm senza / con maniglia without / with handle	937 x 821/885 x 875(h) mm senza / con maniglia without / with handle	937 x 827/890 x 1211(h) mm senza / con maniglia without / with handle
			
	89 Kg	98 Kg	135 Kg
	105 Kg	115 Kg	153 Kg
	1020 x 970 x 868(h) mm	1020 x 970 x 1028(h) mm	1020 x 970 x 1363(h) mm
	0,859 m³	1,020 m³	1,350 m³

RU Смешанные конвекционные/прямые паровые печи с сенсорным управлением. Конструкция из нержавеющей стали - светодиодное внутреннее освещение - центробежный вентилятор с автореверсированием (2 для TOP4TN и TOP6TN, 3 для TOP10TN) - дверь с двойным остеклением (внутреннее стекло может быть открыто) - слив воды - стандартный комплект для мойки - универсальная опора для лотков GN1/1 или кондитерских изделий размером 60x40 см (лотки не входят в комплект поставки). Сенсорное управление с помощью 120 программ - до 6 циклов приготовления в автоматической последовательности в каждой программе - автоматический предварительный нагрев - регулирование выпуска пара - цифровое регулирование впрыска воды - датчик температуры сердечника - интегрированное управление воздушными клапанами открытого/закрытого типа - 5-дюймовый емкостной сенсорный экран - возможность подключения через USB 2.0.

TOP4DN
TOP6DN
TOP10DN



TOP4DN



TOP6DN

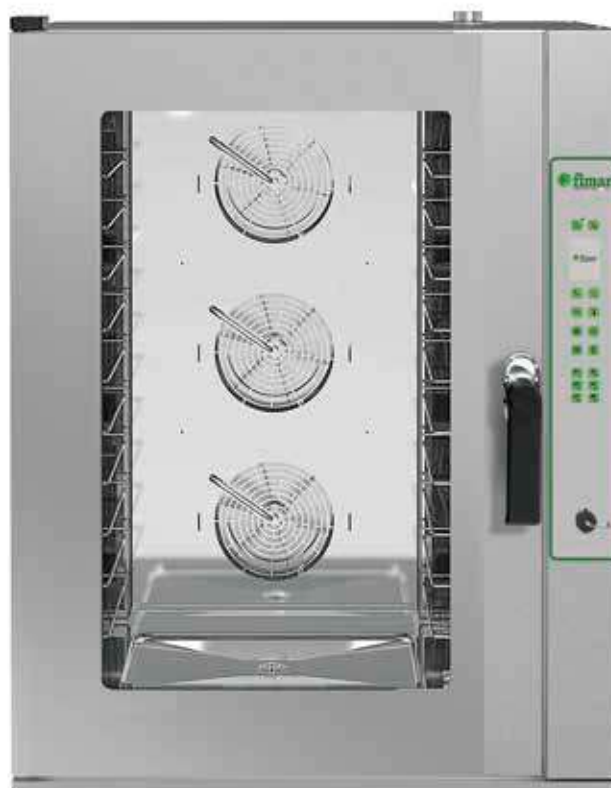

TOP10DN

** Teglie non incluse.
Trays not included.
Plaques pas incluses.
Bleche nicht inbegriffen.
Bandejas no incluidas.
Противни не входят в комплект.

MIXED CONVECTION/DIRECT STEAM OVENS
FOURS MIXTES À CONVECTION ET À VAPEUR DIRECTE
KOMBINIERTHE HEISSLUFT-/DIREKTDAMPFBACKÖFEN
HORNOS MIXTOS CONVECCIÓN/VAPOR DIRECTO
СМЕШАННЫЕ КОНВЕКЦИОННЫЕ/ПРЯМЫЕ ПАРОВЫЕ ПЕЧИ

Forni misti digitali
convezione/vapore diretto GN1/1 60x40











IT Forni misti convezione/vapore diretto. Struttura in acciaio inox - illuminazione interna a LED - ventilatore centrifugo con autoreverse (2 ventole per il TOP4DN e per il TOP6DN, 3 ventole per il TOP10DN) - porta con doppio vetro (vetro interno apribile) - scarico acqua - predisposizione kit lavaggio. Controllo digitale con 99 programmi - fino a 4 cicli di cottura in sequenza automatica per programma - preriscaldamento automatico - regolazione iniezione acqua digitale - sonda al cuore - regolazione ventole a 5 velocità - sistema che velocizza l'eliminazione di umidità in camera di cottura all'occorrenza - LED da 2.4 pollici a colori - multi timer - connettività wifi e USB 2.0 per caricamento delle ricette.

EN Mixed convection/direct steam ovens with touch controls. Stainless steel casing - internal LED lamp - centrifugal fan with automatic reverse (2 on mod. TOP4DN and TOP6DN, 3 on mod TOP10DN) - double-glazed door (removable internal glass) - water drain - set up for washing kit. Digital control with 99 programs - up to 4 cooking cycles in automatic sequence per program - automatic preheating - steam drain regulation - digital water injection regulation - core probe - 5-speed fan regulation - system that speeds up moisture removal in the cooking chamber when needed - 2.4 inch colour LED - multi timer - Wi-Fi and USB 2.0 connection for uploading recipes.

FR Fours mixtes à convection et à vapeur directe avec commandes tactiles. Corps en acier Inox - éclairage interne à LED - ventilateur centrifuge avec inverseur automatique (2 pour TOP4DN et TOP6DN, 3 pour TOP10DN) - porte avec double vitrage (possibilité d'ouvrir le verre interne) - évacuation de l'eau - kit de lavage prêt à poser. Commande numérique avec 99 programmes - jusqu'à 4 cycles de cuisson en séquence automatique par programme - préchauffage automatique - régulation de l'évacuation de la vapeur - régulation numérique de l'injection d'eau - sonde à cœur - régulation à 5 vitesses du ventilateur - système qui accélère l'élimination de l'humidité dans la chambre de cuisson lorsque c'est nécessaire - LED couleur de 2,4 pouces - minuterie multiple - connectivité wifi et USB 2.0 pour télécharger des recettes.

DE Kombinierte Heißluft-/Direktdampfbacköfen mit Touch-Steuerung. Edelstahlgehäuse - interne Ledbeleuchtung - Zentrifugalgebläse mit automatischer Wendefunktion - (2 für TOP4DN und TOP6DN, 3 für TOP10DN) - Tür mit Doppelverglasung (Innenglas kann geöffnet werden) - Wasserablauf - Wasch-Set bereit. Digitale Steuerung mit 99 Programmen - bis zu 4 Kochzyklen in automatischer Abfolge pro Programm - automatische Vorwärmung - Dampfaustrittseinstellung - digitale Wassereinspritzeneinstellung - Kerntemperaturfühler - Lüftereinstellung mit 5 Stufen - schnelles Entfeuchtungssystem für den Gärraum - 2,4-Zoll-LED-Farbdisplay - Multitimer - Wi-Fi- und USB-2.0-Anschluss zum Hochladen von Rezepten.

ES Hornos mixtos de convección/vapor directo. Estructura de acero inoxidable - iluminación interna por leds - ventilador centrifugo con autorreversaciones (2 ventiladores para TOP4DN y TOP6DN, 3 ventiladores para TOP10DN) - puerta con doble acristalamiento (se puede abrir el cristal interior) - drenaje de agua - kit de lavado listo. Control digital con 99 programas - hasta 4 ciclos de cocción en secuencia automática por programa - precalentamiento automático - control digital de la inyección de agua - sonda de corazón - control del ventilador de 5 velocidades - sistema que acelera la eliminación de la humedad en la cámara de cocción si es necesario - LED en color de 2,4 pulgadas - multitemporizador - conectividad wifi y usb 2.0 para cargar recetas.

	TOP4DN	TOP6DN	TOP10DN
	10,8 kW		16,1 kW
	400V/3N/50-60Hz		
	230V/1N/50-60Hz		-
	50÷260°C		
	Digitale - Digital - Цифровой 0÷120'		
	4 x 600 x 400 mm** GN1/1 - P = 80 mm	6 x 600 x 400 mm** GN1/1 - P = 80 mm	10 x 600 x 400 mm** GN1/1 - P = 80 mm
	660 x 490 x 452(h) mm	660 x 490 x 612(h) mm	660 x 490 x 948(h) mm
	937 x 821/885 x 715(h) mm senza / con maniglia without / with handle	937 x 821/885 x 875(h) mm senza / con maniglia without / with handle	937 x 827/890 x 1211(h) mm senza / con maniglia without / with handle
			
	87 Kg	98 Kg	135 Kg
	103 Kg	115 Kg	153 Kg
	1020 x 970 x 868(h) mm	1020 x 970 x 1028(h) mm	1020 x 970 x 1363(h) mm
	0,860 m³	1,020 m³	1,337 m³

RU Смешанные конвекционные/прямоточные паровые печи. Конструкция из нержавеющей стали - внутреннее светодиодное освещение - центробежный вентилятор с автореверсом (2 вентилятора для TOP4DN и TOP6DN, 3 вентилятора для TOP10DN) - дверца с двойным стеклом (внутреннее стекло можно открыть) - слив воды - предрасположенность к мытью комплекта. Цифровое управление с 99 программами - до 4 циклов приготовления в автоматической последовательности для каждой программы - автоматический предварительный нагрев - цифровой контроль впрыска воды - термощуп - 5-скоростное управление вентилятором - система, ускоряющая устранение влажности в рабочей камере при необходимости - цветной светодиодный индикатор 2,4 дюйма - мультитаймер - возможность подключения к Wi-Fi и USB 2.0 для загрузки рецептов.

TOP4M
TOP6M
TOP10M



TOP4M



TOP6M

















TOP10M

Forni misti meccanici
convezione/vapore diretto GN1/1 60x40

MIXED CONVECTION/DIRECT STEAM OVENS
FOURS MIXTES À CONVECTION ET À VAPEUR DIRECTE
KOMBINIERTHE HEISSLUFT-/DIREKTDAMPFBÄCKÖFEN
HORNOS MIXTOS CONVECCIÓN/VAPOR DIRECTO
СМЕШАННЫЕ КОНВЕКЦИОННЫЕ/ПРЯМЫЕ ПАРОВЫЕ ПЕЧИ

- IT** Forni misti convezione/vapore diretto. Struttura in acciaio inox - illuminazione interna alogena - ventilatore centrifugo con autoreverse (3 per TOP10M, 2 per TOP4M - 6M) - porta con doppio vetro (vetro interno apribile) - scarico acqua - umidificatore con regolatore di energia (iniezione diretta).
- EN** Mixed convection/direct steam ovens. Stainless steel casing - internal halogen lamp - centrifugal fan with automatic reverse (3 for TOP10M - 2 for TOP4-6M) - double-glazed door (removable internal glass) - water drain - humidifier with energy regulator (direct injection).
- FR** Fours mixtes à convection et à vapeur directe. Corps en acier Inox - éclairage interne halogène - ventilateur centrifuge avec inverseur automatique (3 pour TOP10M - 2 pour TOP4-6M) - porte avec double vitrage (possibilité d'ouvrir le verre interne) - évacuation de l'eau - humidificateur avec régulateur d'énergie (injection directe).
- DE** Kombinierte Heissluft-/Direktdampfbacköfen. Edelstahlgehäuse - interne Halogenbeleuchtung - Zentrifugalgebläse mit automatischer Wendefunktion (3 für TOP10M - 2 für TOP4-6M) - Tür mit Doppelverglasung (Innenglas kann geöffnet werden) - Wasserablauf - Befeuchter mit Energieregler (Direkteinspritzung).
- ES** Hornos mixtos de convección/vapor directo. Estructura de acero inoxidable - iluminación interior halógena - ventilador centrifugo con autorreversaciones (3 para TOP10M - 2 para TOP4-6M) - puerta con doble acristalamiento (se puede abrir el cristal interior) - drenaje de agua - humidificador con regulador de energía (inyección directa).
- RU** Смешанные конвекционные печи/с прямым паром - структура из нержавеющей стали - внутреннее галогенное освещение - центробежный вентилятор с автоматической функцией реверса (3 для TOP10M, 2 для TOP4-6M) - дверца с двойным стеклом (внутреннее стекло открывается) - слив воды - увлажнитель с регулятором энергии (прямое впрыскивание).

	TOP4M	TOP6M	TOP10M
	10,8 kW		16,1 kW
	400V/3N/50-60Hz		400V/3/50-60Hz
	230V/1N/50-60Hz		-
	50±260°C		
	Meccanico - Mechanical - Механический 0±120'		
	4 x 600 x 400 mm** GN1/1 - P = 80 mm	6 x 600 x 400 mm** GN1/1 - P = 80 mm	10 x 600 x 400 mm** GN1/1 - P = 80 mm
	660 x 480 x 455(h) mm	660 x 480 x 615(h) mm	660 x 480 x 950(h) mm
	940 x 890 x 715(h) mm	940 x 890 x 875(h) mm	940 x 890 x 1211(h) mm
			
	87 Kg	101 Kg	135 Kg
	105 Kg	116 Kg	149 Kg
	1020 x 970 x 900(h) mm	1020 x 970 x 1000(h) mm	1020 x 970 x 1350(h) mm
	0,851 m³	0,989 m³	1,316 m³

** Teglie non incluse.
Trays not included.
Plaques pas incluses.
Bleche nicht inbegriffen.
Bandejas no incluidas.
Противни не входят в комплект.

STR6
STR10



STR10



STR6

Forni a convezione meccanici GN1/1 60x40

MECHANICAL CONVECTION OVENS
FOURS À CONVECTION MÉCANIQUE
MECHANISCHE KOMBIÖFEN
HORNOS DE CONVECCIÓN MECÁNICA
МЕХАНИЧЕСКИЕ КОНВЕКЦИОННЫЕ ПЕЧИ

- IT** Forni a convezione meccanici. Struttura in acciaio inox con porta doppio vetro (vetro interno apribile) - illuminazione interna alogena - umidificatore con regolatore di energia (iniezione diretta) - ventilatori centrifughi con autoreverse (3 per STR10 e 2 per STR6).
- EN** Mechanical convection ovens. Stainless steel casing with doubleglazed door (removable internal glass) - internal halogen lamp - humidifier with energy regulator (direct injection) - centrifugal fan with automatic reverse (3 for STR10 - 2 for STR6).
- FR** Fours à convection mécanique. Corps en acier Inox avec porte avec double vitrage (possibilité d'ouvrir le verre interne) - éclairage interne halogène - humidificateur avec régulateur d'énergie (injection directe) - ventilateur centrifuge avec inverseur automatique (3 pour STR10 - 2 pour STR6).
- DE** Mechanische Kombiöfen. Edelstahlgehäuse und Tür mit Doppelverglasung (Innenglas kann geöffnet werden) - interne Halogenbeleuchtung - Befeuchter mit Energieregler (Direkteinspritzung) - Zentrifugalgebläse mit automatischer Wendefunktion (3 für STR10 - 2 für STR6).
- ES** Hornos de convección mecánica. Estructura de acero inoxidable y puerta con doble acristalamiento (se puede abrir el cristal interior) - iluminación interior halógena - humidificador con regulador de energía (inyección directa) - ventilador centrifugo con autorreversaciones (3 para STR10 - 2 para STR6).
- RU** механические конвекционные печи. Конструкция из нержавеющей стали и дверь с двойным остеклением (внутреннее стекло может быть открыто) - галогенное внутреннее освещение - увлажнитель с регулятором энергии (прямое впрыскивание) - центробежный вентилятор с автореверсированием (3 для STR10 - 2 для STR6).

	STR6	STR10
	10,4 kW	16,1 kW
	400V/3N/50Hz	400V/3/50Hz
	230V/1N/50Hz	-
	50÷300°C	
	Meccanico - Mechanical - Механический 0÷120'	
	6 x 600 x 400 mm** GN1/1 - P = 80 mm	10 x 600 x 400 mm** GN1/1 - P = 80 mm
	460 x 630 x 612(h) mm	460 x 630 x 948(h) mm
	792 x 954/1021 x 941(h) mm senza / con maniglia without / with handle	793 x 954/1021 x 1277(h) mm senza / con maniglia without / with handle
		
	100 Kg	134 Kg
	115 Kg	150 Kg
	880 x 1110 x 1118(h) mm	880 x 1110 x 1456(h) mm
	1,09 m ³	1,42 m ³

** Teglie non incluse.
Trays not included.
Plaques pas incluses.
Bleche nicht inbegriffen.
Bandejas no incluidas.
Противни не входят в комплект.

FOALTOP10T
FOALTOP64T
FOALSTR



FOALTOP10T





FOALTOP64T

Armadi lievitatori

per forni serie Top e Start

PROVING CABINET FOR OVENS
ARMOIRES DE LEVAGE POUR FOURS
GÄRSCHRÄNKE FÜR ÖFEN
ARMARIOS FERMENTADORES PARA HORNOS
ЯЧЕЙКИ РАССТРОЕЧНЫЕ ДЛЯ ПЕЧЕЙ

- IT** Armadi riscaldati/lievitori per forni. Struttura in acciaio inox e porta in vetro - termostato - bacinella per l'acqua sul fondo dell'armadio.
FOALTOP10T: 12 teglie - per modello forno TOP10.
FOALTOP64T: 8 teglie - per modelli forni TOP4 e TOP6.
FOALSTR: 12 teglie - per modelli forni STR6 e STR10.
- EN** Heated/Proving cabinets for ovens. Stainless steel casing and glass door - thermostat - water basin at the bottom of the cabinet.
FOALTOP10T: 12 trays - for oven model TOP10.
FOALTOP64T: 8 trays - for oven models TOP4 and TOP6.
FOALSTR: 12 trays - for oven models STR6 and STR10.
- FR** Armoires/ascenseurs chauffants pour fours. Structure en acier Inox et porte vitrée - thermostat - bac à eau au fond de l'armoire.
FOALTOP10T: 12 plaques - pour le modèle TOP10.
FOALTOP64T: 8 plaques - pour les modèles TOP4 et TOP6.
FOALSTR: 12 plaques - pour les modèles STR6 et STR10.
- DE** Warmhalteschränke/Gärschränke für Öfen - Edelstahlgehäuse und Glastür - Thermostat - Wasserbehälter am Schrankboden.
FOALTOP10T: 12 Bleche - für das Modell TOP10.
FOALTOP64T: 8 Bleche - für die Modelle TOP4 und TOP6.
FOALSTR: 12 Bleche - für die Modelle STR6 und STR10.
- ES** Armarios/elevadores calefaccionados para hornos. Estructura de acero inoxidable y puerta de vidrio - termostato - depósito de agua en la parte inferior del armario.
FOALTOP10T: 12 bandejas - para horno modelo TOP10.
FOALTOP64T: 8 bandejas - para hornos modelo TOP4 y TOP6.
FOALSTR: 12 bandejas - para hornos modelo STR6 y STR10.
- RU** Отапливаемые шкафы/лифты для печей. Конструкция из нержавеющей стали и стеклянная дверь - термостат - водяной резервуар в нижней части шкафа.
FOALTOP10T: 12 противней - для печи модели TOP10.
FOALTOP64T: 8 противней - для печей моделей TOP4 и TOP6.
FOALSTR: 12 противней - для печей моделей STR6 и STR10.

	FOALTOP10T	FOALTOP64T	FOALSTR
	2 kW		2,6 kW
 1 Ph	230V/1N/50-60Hz		
	Max. 60°C		
 N.	12 x 600 x 400 mm** GN1/1 P = 75 mm	8 x 600 x 400 mm** GN1/1 P = 75 mm	12 x 600 x 400 mm** GN1/1 P = 80 mm
	817 x 826 x 621(h) mm	625 x 713 x 707(h) mm	410 x 860 x 540(h) mm
 mm	935 x 855 x 706(h) mm	935 x 803 x 867(h) mm	792 x 903 x 706(h) mm
			
 NET Kg	50 Kg	48 Kg	
 GROSS Kg	65 Kg	62 Kg	
 mm	980 x 950 x 850(h) mm	975 x 840 x 993(h) mm	850 x 940 x 832(h) mm
 m ³	0,772 m ³	0,813 m ³	0,664 m ³

** Teglie non incluse.
Trays not included.
Plaques pas incluses.
Bleche nicht inbegriffen.
Bandejas no incluidas.
Противни не входят в комплект.

Cappa a condensazione

CONDENSING HOOD
HOTTE DE CONDENSATION
KONDENSATIONSHAUBE
CAMPANA DE CONDENSACIÓN
КОНДЕНСАЦИОННЫЙ
КОНДЕНСАЦИОННЫЙ КОЛПАК

IT Cappa a condensazione in acciaio inox - due filtri antigrasso in acciaio inox - due velocità di estrazione.

EN Stainless steel condensing hood - two stainless steel grease filters - two extraction speeds.

FR Hotte de condensation en acier Inox - deux filtres à graisse en acier Inox - deux vitesses d'extraction.

DE Kondensationshaube aus Edelstahl - zwei Fettfilter aus Edelstahl - zwei Absauggeschwindigkeiten.

ES Campana de condensación de acero inoxidable - dos filtros antigrasa de acero inoxidable - dos velocidades de extracción.

RU Конденсационный конденсационный колпак из нержавеющей стали - два фильтра для смазки из нержавеющей стали две скорости вытяжки.

	ACCAPSTR	ACCAPTOP	ACCAPTOPT	ACCAPSLIM23M
Mod.	STR6 - STR10	TOP4M - TOP4DN TOP6M - TOP6DN TOP10M - TOP10DN	TOP4TN - TOP6TN TOP10TN	SLIM6D - SLIM623D SLIM6M - SLIM623M
	0,3kW			
	230V/1N/50-60Hz			
	790 x 991 x 320(h) mm	937 x 892 x 323(h) mm		532 x 853 x 323(h) mm
	30 Kg	32 Kg		25 Kg
	38 Kg	39 Kg		31 Kg
	800 x 1200 x 365(h) mm	1030 x 960 x 496(h) mm		
	0,350 m³	0,495 m³		0,490 m³

	ACDOC
	Doccetta - Shower - Douchette Handbrause - Ducha manual - Душручной
Mod.	TOPM - TOPDN
	1 Kg
	1,2 Kg
	150 x 100 x 50(h) mm
	0,001 m³



ACCAPTOP



ACDOC

Supporti per forni

SUPPORTS FOR OVENS
SUPPORTS POUR FOURS
ÖFENGESTELL
SOPORTES PARA HORNOS
ОПОРЫ ДЛЯ ПЕЧЕЙ С КОНСТРУКЦИЕЙ

IT Supporti per forni con struttura in acciaio inox forniti in kit di montaggio.
EN Stainless steel supports for ovens supplied in assembly kit.
FR Supports pour fours avec structure en acier Inox fournis en kit de montage.

DE Öfengestell aus Edelstahl im Lieferumfang des Montagesatzes.
ES Soportes para hornos con estructura de acero inoxidable incluidos en el kit de montaje.
RU Опоры для печей с конструкцией из нержавеющей стали, входящей в монтажный комплект.

	FOCAVSTR	FOCAVTOP10	FOCAVTOP64	FOCAVSLIM
Mod.	STR6 - STR10	TOP10M - TOP10DN TOP10TN	TOP4M - TOP4DN - TOP4TN TOP6M - TOP6DN - TOP6TN	SLIM6D - SLIM6M
	6x 600 x 400 mm GN1/1 P= 80 mm			6x GN1/1
	790 x 735 x 700(h) mm	920 x 620 x 700(h) mm	920 x 620 x 800(h) mm	530 x 610 x 800(h) mm
	21,5 Kg	21 Kg	23 Kg	21 Kg
	22,5 Kg	22 Kg	24 Kg	23 Kg
	830 x 830 x 300(h) mm	680 x 1000 x 280(h) mm		
	0,206 m³	0,190 m³		

	ACKITLAV
	Kit lavaggio per forni - Oven washing kit Kit lavage - Spülkit - Kit de lavado Моющий комплект
Mod.	TOPDN
	2,8 Kg
	3,2 Kg
	850 x 180 x 125(h) mm
	0,019 m³



FOCAVSTR



FOCAVTOP10



FOCAVTOP64



FOCAVSLIM



ACKITLAV

CMP423D
CMP4GPD



CMP423D



CMP4GPD

Forni a convezione compatti digitali

COMPACT CONVECTION OVENS
FOURS À CONVECTION COMPACTS
KOMPAKTE KOMBIÖFEN
HORNOS DE CONVECCIÓN COMPACTOS
КОМПАКТНЫЕ КОНВЕКЦИОННЫЕ ПЕЧИ

- IT** Forni a convezione con umidificatore. Struttura in acciaio inox - porta a ribalta - illuminazione interna alogena - porta doppio vetro - controllo digitale con 99 programmi - fino a 3 cicli di cottura in sequenza automatica - preriscaldamento automatico - regolazione iniezione acqua digitale - 2 ventilatori centrifughi con autoreverse per il CMP4GPD ed 1 ventilatore per il CMP423D.
- EN** Convection ovens with humidifier. Stainless steel casing - tilting door - internal halogen lamp - double-glazed door - digital control with 99 programs - up to 3 cooking cycles in automatic sequence - automatic preheating - digital water injection regulation - 2 centrifugal fans with automatic reverse on mod. CMP4GPD and 1 fan on mod. CMP423D.
- FR** Fours à convection avec humidificateur. Corps en acier Inox - porte basculante - éclairage halogène interne - porte à double vitrage - commande numérique avec 99 programmes - jusqu'à 3 cycles de cuisson en séquence automatique - préchauffage automatique - régulation numérique de l'injection d'eau - 2 ventilateurs centrifuges avec retour automatique pour le CMP4GPD et 1 ventilateur pour le CMP423D.
- DE** Heißluftöfen mit Befeuchter. Edelstahlstruktur - Klapptür - Halogen-Innenbeleuchtung - Tür mit Doppelverglasung - digitale Steuerung mit 99 Programmen - bis zu 3 Kochzyklen in automatischer Abfolge - automatische Vorwärmung - digitale Wassereinspritzeneinstellung - 2 Zentrifugalgebläse mit automatischer Wendefunktion für Mod. CMP4GPD und 1 Gebläse für Mod. CMP423D.
- ES** Hornos de convección con humidificador. Estructura de acero inoxidable - puerta batiente - iluminación halógena interna - con doble acristalamiento - control digital con 99 programas - hasta 3 ciclos de cocción en secuencia automática - precalentamiento automático - regulación digital de la inyección de agua - 2 ventiladores centrifugos con autorreversa para el CMP4GPD y 1 ventilador para el CMP423D.
- RU** Конвекционные печи с увлажнителем воздуха. Конструкция из нержавеющей стали - дверца люка - внутреннее галогенное освещение - двойное остекление - цифровое управление с 99 программами - до 3 циклов готовки в автоматической последовательности - автоматический предварительный нагрев - цифровое регулирование впрыска воды - 2 центробежных вентилятора с реверсом для CMP4GPD и 1 вентилятор для CMP423D.

	CMP423D	CMP4GPD
	3 kW	6,7 kW
	-	400V/3N/50-60Hz
	230V/1N/50-60Hz	
	50±260°C	
	Digitale - Digital - цифровой 0÷120'	
	4 x 450 x 340 mm* GN2/3 - P = 75 mm	4 x 600 x 400 mm** GN1/1 - P = 75 mm
	474 x 378 x 320(h) mm	660 x 456 x 340(h) mm
	560 x 639/683 x 530(h) mm senza / con maniglia without / with handle	750 x 708/755 x 553(h) mm senza / con maniglia without / with handle
		
	33 Kg	45 Kg
	41 Kg	50 Kg
	584 x 724 x 680(h) mm	774 x 764 x 682(h) mm
	0,287 m³	0,406 m³

	ACGRICMP4534	ACTE423V
	Griglia acciaio inox Stainless steel grill Grille en acier inox Edelstahl Gitter Rejilla de acero inoxidable Решётка из нерж. стали	Teglia acciaio inox Stainless steel tray Plaque en acier inox Blech aus Edelstahl Bandeja de acero inoxidable Противень из нерж. стали
Mod.	CMP423D - CMP423M	
	450 x 340 mm	

* Teglie incluse.
Trays included.
Plaques incluses.
Bleche inbegriffen.
Bandejas incluidas.
Листы включены.

** Teglie non incluse.
Trays not included.
Plaques pas incluses.
Bleche nicht inbegriffen.
Bandejas no incluidas.
Противни не входят в комплект.

CMP4GPM
CMP4GPMI



CMP4GPM



CMP4GPMI

Forni a convezione compatti meccanici 60x40

COMPACT CONVECTION OVENS
FOURS À CONVECTION COMPACTS
KOMPAKTE KOMBIÖFEN
HORNOS DE CONVECCIÓN COMPACTOS
КОМПАКТНЫЕ КОНВЕКЦИОННЫЕ ПЕЧИ

- IT** Forni a convezione con umidificatore. Struttura in acciaio inox - porta a ribalta - illuminazione interna alogena - porta doppio vetro - regolazione iniezione acqua manuale - 2 ventilatori centrifughi con autoreverse per il CMP4GPMI ed 1 ventilatore per il CMP4GPM.
- EN** Convection ovens with humidifier. Stainless steel casing - tilting door - internal halogen lamp - double-glazed door - manual water injection regulation - 2 centrifugal fans with automatic reverse on mod. CMP4GPMI and 1 fan on mod. CMP4GPM.
- FR** Fours à convection avec humidificateur. Corps en acier Inox - porte basculante - éclairage halogène interne - porte à double vitrage - régulation manuelle de l'injection d'eau - 2 ventilateurs centrifuges avec retour automatique pour le CMP4GPMI et 1 ventilateur pour le CMP4GPM.
- DE** Heißluftöfen mit Befeuchter. Edelstahlstruktur - Klapptür - Halogen-Innenbeleuchtung - Tür mit Doppelverglasung - manuelle Wassereinspritzstellung - 2 Zentrifugalgebläse mit automatischer Wendefunktion für Mod. CMP4GPMI und 1 Gebläse für Mod. CMP4GPM.
- ES** Hornos de convección con humidificador. Estructura de acero inoxidable - puerta batiente - iluminación halógena interna - puerta con doble acristalamiento - regulación manual de la inyección de agua - 2 ventiladores centrifugos con autorreversa para el CMP4GPMI y 1 ventilador para el CMP4GPM.
- RU** Конвекционные печи с увлажнителем воздуха. Конструкция из нержавеющей стали - распашная дверь - внутреннее галогенное освещение - дверь с двойным остеклением - ручное регулирование впрыска воды - 2 центробежных вентилятора с реверсом для CMP4GPMI и 1 вентилятор для CMP4GPM.

	CMP4GPM	CMP4GPMI
	3,4 kW	6,7 kW
	-	400V/3N/50-60Hz
	230V/1N/50-60Hz	
	50÷280°C	
	Meccanico - Mechanical - Механический 0÷120'	
	4 x 600 x 400 mm** GN1/1 - P = 75 mm	
	660 x 456 x 340(h) mm	
	750 x 645/693 x 553(h) mm senza / con maniglia without / with handle	750 x 708/755 x 553(h) mm senza / con maniglia without / with handle
		
	45 Kg	
	50 Kg	
	774 x 764 x 682(h) mm	
	0,403 m³	

** Teglie non incluse.
Trays not included.
Plaques pas incluses.
Bleche nicht inbegriffen.
Bandejas no incluidas.
Противни не входят в комплект.

CMP332M
CMP423M



CMP332M



CMP423M

Forni a convezione













compatti meccanici

COMPACT CONVECTION OVENS
FOURS À CONVECTION COMPACTS
KOMPAKTE KOMBIÖFEN
HORNOS DE CONVECCIÓN COMPACTOS
КОМПАКТНЫЕ КОНВЕКЦИОННЫЕ ПЕЧИ

- IT** Forni a convezione. Struttura in acciaio inox - porta a ribalta - illuminazione interna alogena - porta doppio vetro. 4 teglie in acciaio incluse per il modello CMP423M - 3 teglie in alluminio incluse per il modello CMP332M.
- EN** Convection ovens. Stainless steel casing - tilting door - internal halogen lamp - double-glazed door. 4 steel trays included on model CMP423M - 3 aluminium trays included on model CMP332M.
- FR** Fours à convection. Corps en acier Inox - porte basculante - éclairage halogène interne - porte à double vitrage. 4 plaques en acier incluses pour le modèle CMP423M - 3 plaques en aluminium incluses pour le modèle CMP332M.
- DE** Heißluftöfen. Edelstahlstruktur - Klapptür - Halogen-Innenbeleuchtung - Tür mit Doppelverglasung. 4 Stahlbleche enthalten für Modell CMP423M - 3 Aluminiumbleche enthalten für Modell CMP332M.
- ES** Hornos de convección. Estructura de acero inoxidable - puerta batiente - iluminación halógena interna - puerta con doble acristalamiento. 4 bandejas de acero incluidas para el modelo CMP423M - 3 bandejas de aluminio incluidas para el modelo CMP332M.
- RU** Конвекционные печи. Конструкция из нержавеющей стали - распашная дверь - внутреннее галогенное освещение - дверь с двойным остеклением. 4 стальных лотка входят в комплект поставки модели CMP423M - 3 алюминиевых лотка входят в комплект поставки модели CMP332M.

	ACGRI332V	ACGRICMP4534
	Griglia acciaio inox - Stainless steel grill - Grille en acier inox Edelstahl Gitter - Rejilla de acero inoxidable - Решётка из нерж. стали	
Mod.	CMP332M	CMP423M - CMP423D
	346 x 260 mm	450 x 340 mm

	ACTE332V	ACTE423V
	Teglia acciaio inox - Stainless steel tray - Plaque en acier inox - Blech aus Edelstahl - Bandeja de acero inoxidable - Противень из нерж. стали	
Mod.	CMP332M	CMP423M - CMP423D
	346 x 260 mm	450 x 340 mm

	CMP332M	CMP423M
	2,9 kW	
	230V/1N/50Hz	
	50÷280°C	
	Meccanico - Mechanical - Механический 0÷120'	
	3 x 346 x 260 mm*	4 x 450 x 340 mm* GN2/3 - P = 75 mm
	379 x 338 x 245(h) mm	474 x 400 x 320(h) mm
	465 x 520/570 x 455(h) mm senza / con maniglia without / with handle	560 x 588/632 x 530(h) mm senza / con maniglia without / with handle
		
	25 Kg	28 Kg
	30 Kg	35 Kg
	505 x 660 x 550(h) mm	584 x 724 x 680(h) mm
	0,183 m³	0,284 m³

* Teglie incluse.
Trays included.
Plaques incluses.
Bleche inbegriffen.
Bandejas incluidas.
Листы включены.

FOALCMP4GP
FOALCMP423



FOALCMP4GP



FOALCMP423

Armadi lievitatori per forni CMP

PROVING CABINET FOR OVENS
ARMOIRES DE LEVAGE POUR FOURS
GÄRSCHRÄNKE FÜR ÖFEN
ARMARIOS FERMENTADORES PARA HORNO
ЯЧЕЙКИ РАССТРОЕЧНЫЕ ДЛЯ ПЕЧЕЙ

- IT** Armadi riscaldati/lievitatori per forni a convezione. Struttura in acciaio inox e porta in vetro - bacinella per l'acqua sul fondo dell'armadio.
FOALCMP4GP: 8 teglie - per modelli forni CMP4GPD - CMP4GPM - CMP4GPMI.
FOALCMP423: 8 teglie - per modelli forni CMP423D - CMP423M.
- EN** Heated/Proving cabinets for convection. Stainless steel casing and glass door - thermostat - water basin at the bottom of the cabinet.
FOALCMP4GP: 8 trays - for ovens model CMP4GPD - CMP4GPM - CMP4GPMI.
FOALCMP423: 8 trays - for ovens model CMP423D - CMP423M.
- FR** Armoires/ascenseurs chauffants pour fours à convection. Structure en acier Inox et porte vitrée - thermostat - bac à eau au fond de l'armoire.
FOALCMP4GP: 8 plaques - pour les modèles CMP4GPD - CMP4GPM - CMP4GPMI.
FOALCMP423: 8 plaques - pour les modèles CMP423D - CMP423M.
- DE** Warmhalteschränke/Gärschränke für Konvektions - Edelstahlgehäuse und Glastür - Thermostat - Wasserbehälter am Schrankboden.
FOALCMP4GP: 8 Bleche - für die Modelle CMP4GPD - CMP4GPM - CMP4GPMI.
FOALCMP423: 8 Bleche - für die Modelle CMP423D - CMP423M.
- ES** Armarios/elevadores calefaccionados para hornos de convección. Estructura de acero inoxidable y puerta de vidrio - termostato - depósito de agua en la parte inferior del armario.
FOALCMP4GP: 8 bandejas - para hornos modelo CMP4GPD - CMP4GPM - CMP4GPMI.
FOALCMP423: 8 bandejas - para hornos modelo CMP423D - CMP423M.
- RU** Шкафы подогрева/расстроечные для кофнлвие. Конструкция из нержавеющей стали и стеклянная дверь - термостат - водяной резервуар в нижней части шкафа.
FOALCMP4GP: 8 противней - для печей моделей CMP4GPD - CMP4GPM - CMP4GPMI.
FOALCMP423: 8 противней - для печей моделей CMP423D - CMP423M.

	FOALCMP4GP	FOALCMP423
	2 kW	
 1 Ph	230V/1N/50-60Hz	
	Max. 60°C	
 N.	8 x 600 x 400 mm** GN1/1 P = 75 mm	8 x 450 x 340 mm** GN2/3 P = 75 mm
	610 x 610 x 700(h) mm	480 x 540 x 700(h) mm
 mm	800 x 690 x 860(h) mm	600 x 690 x 860(h) mm
		
 NET Kg	36 Kg	28 Kg
 GROSS Kg	50 Kg	40 Kg
 mm	860 x 800 x 1010(h) mm	660 x 700 x 1010(h) mm
 m ³	0,695 m ³	0,467 m ³

** Teglie non incluse.
Trays not included.
Plaques pas incluses.
Bleche nicht inbegriffen.
Bandejas no incluidas.
Противни не входят в комплект.

Supporti per forni

SUPPORTS FOR OVENS
SUPPORTS POUR FOURS
ÖFENGESTELL
SOPORTES PARA HORNOS
ОПОРЫ ДЛЯ ПЕЧЕЙ С КОНСТРУКЦИЕЙ

IT Supporti per forni con struttura in acciaio inox forniti in kit di montaggio.







EN Stainless steel supports for ovens supplied in assembly kit.

FR Supports pour fours avec structure en acier Inox fournis en kit de montage.

DE Öfengestell aus Edelstahl im Lieferumfang des Montagesatzes.

ES Soportes para hornos con estructura de acero inoxidable incluidos en el kit de montaje.

RU Опоры для печей с конструкцией из нержавеющей стали, входящей в монтажный комплект.

	FOCAVCMP4GP	FOCAVCMP423
Mod.	CMP4GPD - CMP4GPM - CMP4GPMI	CMP423D - CMP423M
	6x 600 x 400 mm GN1/1 P= 80 mm	6x 450 x 340 mm P= 100 mm
	792 x 570 x 800(h) mm	592 x 530 x 800(h) mm
	21 Kg	19 Kg
	22 Kg	21 Kg
	680 x 850 x 350(h) mm	650 x 800 x 350(h) mm
	0,202 m³	0,182 m³



FOCAVCM4GP



FOCAVCM423



FN423E
FN423EV



FN423E



FN423EV

Forni a convezione
elettrici per gastronomia GN2/3

CONVECTION OVENS
FOURS À CONVECTION
KOMBIÖFEN
HORNOS DE CONVECCIÓN
КОНВЕКЦИОННЫЕ ПЕЧИ

- IT** Forni a convezione elettrici. Struttura in acciaio inox - illuminazione interna - 1 ventilatore centrifugo - umidificatore automatico con regolatore di energia per il mod. FN423EV - selettore a 8 funzioni (defrost, 4 modalità a convezione, 2 modalità grill, solo ventola) - porta con doppio vetro interno estraibile - guarnizione porta ad incasso - cassetto raccolta condensa estraibile - guide supporto teglie estraibili - 1 griglia compresa.
- EN** Electric convection ovens. Stainless steel casing - internal lighting - 1 centrifugal fan - automatic humidifier with energy regulator for model FN423EV - 8-function selector (defrost, 4 convection modes, 2 grill modes, fan only) - double-glazed door with removable internal glass - built-in door gasket - removable condensate drain drawer - removable tray slides - 1 grid included.
- FR** Fours électriques à convection. Structure en acier Inox - éclairage intérieur - 1 ventilateur centrifuge - humidificateur automatique avec régulateur d'énergie pour le modèle FN423EV - sélecteur 8 fonctions (dégivrage, 4 modalités de convection, 2 de grillage, ventilateur seulement) - porte avec double vitrage intérieur amovible - joint de porte intégré - bac extractible pour la récupération du condensat - glissières support plateau amovible - 1 grille en dotation.
- DE** Elektrische Heißluftöfen. Edelstahlgehäuse - Innenbeleuchtung - 1 Zentrifugalgebläse - automatischer Befeuchter mit Energieregler für das Modell FN423EV - 8 Funktionsschalter (Abtauen, 4 Umluftbetriebsarten, 2 Grillbetriebsarten, nur Gebläse) - Tür mit doppelt ausziehbarem Innenglas - eingebaute Türdichtung - ausziehbare Kondenswasser Sammelkasten - ausziehbare Blechführungen - 1 Gitter inbegriffen.
- ES** Hornos eléctricos de convección. Estructura de acero inoxidable - iluminación interior - 1 ventilador centrifugo - humidificador automático con regulador de energía para el modelo FN423EV - selector de 8 funciones (desescarche, 4 modalidades de convección, 2 modalidades de parrilla, sólo ventilador) - puerta con doble vidrio interior extraíble - junta de puerta incorporada - cajón de recogida de condensados extraíble - guías de soporte de bandeja extraíbles - 1 rejilla incluida.
- RU** Электрические конвекционные печи. Конструкция из нержавеющей стали - внутреннее освещение - 1 центробежный вентилятор - автоматический увлажнитель с регулятором энергии для модели FN423EV - 8-функциональный селектор (оттайка, 4 режима конвекции, 2 режима решетки, только вентилятор) - дверь с двойным извлекаемым внутренним стеклом - встроенная прокладка - выдвижной ящик для сбора конденсата - выдвижной поддон с направляющими - 1 решетка в комплекте.

** Teglie non incluse.
Trays not included.
Plaques pas incluses.
Bleche nicht inbegriffen.
Bandejas no incluidas.
Противни не входят в комплект.

	FN423E	FN423EV con umidificatore / with humidifier
	3,1 kW	
 1 Ph	230V/1N/50-60Hz	
	50±270°C	
	Meccanico - Mechanical - Механический 0±120'	
	4 x GN2/3** P = 75 mm	
	390 x 390 x 370(h) mm	
	620 x 600 x 580(h) mm	
		
 NET Kg	35 Kg	
 GROSS Kg	46 Kg	
 mm	680 x 680 x 785(h) mm	
 m³	0,363 m³	

FN423M
FN423MV



FN423M



















FN423MV

Forni a convezione
a gas metano per gastronomia GN2/3

CONVECTION OVENS
FOURS À CONVECTION
KOMBIÖFEN
HORNOS DE CONVECCIÓN
КОНВЕКЦИОННЫЕ ПЕЧИ

- IT** Forni a convezione a gas. Struttura in acciaio inox - illuminazione interna - porta con doppio vetro, vetro interno estraibile - guide supporto teglie estraibili - guarnizione porta ad incasso - cassetto raccolta condensa estraibile - 1 ventilatore centrifugo - umidificatore con regolazione di energia e selettore a 3 funzioni (solo per il modello FN423MV defrost, convezione, grill). Allacciamento gas 3/8"G - 1 griglia compresa.
- EN** Gas convection ovens. Stainless steel casing - internal lighting - double-glazed door with removable internal glass - removable tray slides - built-in door gasket - removable condensate drain drawer - 1 centrifugal fan - humidifier with energy regulator and 3-function selector (for model FN423MV only, defrost, convection, grill). Gas connection 3/8"G - 1 grid included.
- FR** Fours à convection à gaz. Corps en acier inox - éclairage intérieur - porte avec double vitrage intérieur amovible - glissières support plateau amovible - joint de porte intégré - bac extractible pour la récupération du condensat - 1 ventilateur centrifuge - humidificateur avec régulateur d'énergie et sélecteur 3 fonctions (que pour le model FN423MV dégivrage, convection, grillage). Raccordement gaz 3/8"G - 1 grille en dotation.
- DE** Gaskonvektionsofen. Edelstahlgehäuse - Innenbeleuchtung - Tür mit doppelt ausziehbarem Innenglas - ausziehbare Blechführungen - eingebaute Türdichtung - ausziehbare Kondenswasser Sammelkasten - 1 Zentrifugalgebläse - Befeuchter mit Energieregler und 3 Funktionsschalter (nur für Model FN423MV, Abtauen, Umluftbetrieb, Grillbetrieb). Gasanschluss 3/8"G - 1 Gitter inbegriffen.
- ES** Hornos de convección de gas. Estructura de acero inoxidable - iluminación interior - puerta con doble vidrio interior extraíble - guías de soporte de bandeja extraíbles - junta de puerta incorporada - cajón de recogida de condensados extraíble - 1 ventilador centrifugo - humidificador automático con regulador de energía para el modelo FN423MV - selector de 3 funciones (desescarche, convección, parrilla). Conexión de gas 3/8"G - 1 rejilla incluida.
- RU** Газовые конвекционные печи. Конструкция из нержавеющей стали - внутреннее освещение - съемная внутренняя дверь с дв ойным остеклением - направляющие - встроенная дверная прокладка -съемный ящик для сбора конденсата - 1 центробежный вентилятор - автоматический увлажнитель с регулятором энергии для модели FN423MV -3-функциональный переключатель (оттайка, конвекция, гриль). Газовое соединение 3/8"G- 1 решетка в комплекте.

	FN423M	FN423MV con umidificatore / with humidifier
	-	1,9 kW
	4 kW	
 1 Ph	230V/1N/50-60Hz	
	50÷270°C	
	Meccanico - Mechanical - Механический 0÷120'	
	3.450 kcal/h 13662 BTU/h	
 METANO METHANE МЕТАНА	G20 = 0,42 m³/h G25 = 0,49 m³/h	
	N° 1 (Bruciatori - Burners - горелки)	
	4 x GN2/3** P = 75 mm	
	390 x 390 x 370(h) mm	
	620 x 645 x 615(h) mm	
		
 NET Kg	38 Kg	
 GROSS Kg	49 Kg	
 mm	680 x 680 x 785(h) mm	
 m³	0,363 m³	

** Teglie non incluse.
Trays not included.
Plaques pas incluses.
Bleche nicht inbegriffen.
Bandejas no incluidas.
Противни не входят в комплект.

FN423G
FN423GV



FN423G



















FN423GV

Forni a convezione
a gas GPL per gastronomia GN2/3

CONVECTION OVENS
FOURS À CONVECTION
KOMBIÖFEN
HORNOS DE CONVECCIÓN
КОНВЕКЦИОННЫЕ ПЕЧИ

- IT** Forni a convezione a gas. Struttura in acciaio inox - illuminazione interna - porta con doppio vetro, vetro interno estraibile - guide supporto teglie estraibili - guarnizione porta ad incasso - cassetto raccolta condensa estraibile - 1 ventilatore centrifugo - umidificatore con regolazione di energia e selettore a 3 funzioni (solo per il modello FN423GV defrost, convezione, grill). Allacciamento gas 3/8"G - 1 griglia compresa.
- EN** Gas convection ovens. Stainless steel casing - internal lighting - double-glazed door with removable internal glass - removable tray slides - built-in door gasket - removable condensate drain drawer - 1 centrifugal fan - humidifier with energy regulator and 3-function selector (for model FN423GV only, defrost, convection, grill). Gas connection 3/8"G - 1 grid included.
- FR** Fours à convection à gaz. Corps en acier Inox - éclairage intérieur - porte avec double vitrage intérieur amovible - glissières support plateau amovible - joint de porte intégré - bac extractible pour la récupération du condensat - 1 ventilateur centrifuge - humidificateur avec régulateur d'énergie et sélecteur 3 fonctions (que pour le model FN423GV dégivrage, convection, grillage). Raccordement gaz 3/8"G - 1 grille en dotation.
- DE** Gaskonvektionsofen. Edelstahlgehäuse - Innenbeleuchtung - Tür mit doppelt ausziehbarem Innenglas - ausziehbare Blechführungen - eingebaute Türdichtung - ausziehbare Kondenswasser Sammelkasten - 1 Zentrifugalebläse - Befeuchter mit Energieregler und 3 Funktionsschalter (nur für Model FN423GV, Abtauen, Umluftbetrieb, Grillbetrieb). Gasanschluss 3/8"G - 1 Gitter inbegriffen.
- ES** Hornos de convección de gas. Estructura de acero inoxidable - iluminación interior - puerta con doble vidrio interior extraíble - guías de soporte de bandeja extraíbles - junta de puerta incorporada - cajón de recogida de condensados extraíble - 1 ventilador centrifugo - humidificador automático con regulador de energía para el modelo FN423GV - selector de 3 funciones (desescarche, convección, parrilla). Conexión de gas 3/8"G - 1 rejilla incluida.
- RU** Газовые конвекционные печи. Конструкция из нержавеющей стали - внутреннее освещение - съемная внутренняя дверь с двойным остеклением - направляющие - встроенная дверная прокладка - съемный ящик для сбора конденсата - 1 центробежный вентилятор - автоматический увлажнитель с регулятором энергии для модели FN423GV - 3-функциональный переключатель (оттайка, конвекция, гриль). Газовое соединение 3/8"G - 1 гриль входит в комплект поставки.

	FN423G	FN423GV con umidificatore / with humidifier
	-	1,9 kW
	4 kW	
 1 Ph	230V/1N/50-60Hz	
	50÷270°C	
	Meccanico - Mechanical - Механический 0÷120'	
	3.450 kcal/h 13662 BTU/h	
	G30 = 0,29 Kg/h G31 = 0,31 Kg/h	
	N° 1 (Bruciatori - Burners - горелки)	
	4 x GN2/3** P = 75 mm	
	390 x 390 x 370(h) mm	
	620 x 645 x 615(h) mm	
		
	38 Kg	
	49 Kg	
	680 x 680 x 785(h) mm	
	0,363 m³	

** Teglie non incluse.
Trays not included.
Plaques pas incluses.
Bleche nicht inbegriffen.
Bandejas no incluidas.
Противни не входят в комплект.

Optional

ACCESSORIES
ACCESSOIRES
ZUBEHÖR
ACCESORIOS
AKCECCYAPЫ

	GNR1140	GRI23	GRI11	GRI64
	Rete acciaio inox per patate - Stainless steel grill for potatoes Grille en acier inox pour les pommes de terre - Edelstahl Gitter für Kartoffel Red de acero inoxidable para patatas - Сетка из нержавеющей стали для картофеля	Griglia acciaio inox - Stainless steel grill Grille en acier inox - Edelstahl Gitter Rejilla de acero inoxidable - Решётка из нерж. стали		
	GN1/1 - 40(h) mm	GN2/3	GN1/1	600 x 400 mm

	GNI2320	GNI2340	GNI2365	GNI1120	GNI1140	GNI1165
	Teglia acciaio inox - Stainless steel tray - Plaque en acier inox - Blech aus Edelstahl - Bandeja de acero inoxidable - Противень из нерж. стали					
	GN2/3 - 20(h) mm	GN2/3 - 40(h) mm	GN2/3 - 65(h) mm	GN1/1 - 20(h) mm	GN1/1 - 40(h) mm	GN1/1 - 65(h) mm

	GNS1120	GNS1140	GNS1165	AVC4940	AV4980	AVF4940
	Teglia smaltata - Coated tray - Plaque émaillée Beschichtetes Blech - Bandeja esmaltada Противень эмалированный			Teglia alluminio - Aluminium tray Plaque en aluminium - Blech aus Aluminium Bandeja de aluminio - Противень из алюминия		Teglia forata alluminio - Aluminium perforated tray Plaque perforée en aluminium - Gelochtes Blech aus Aluminium Bandeja perforada de aluminio - Перфорированный противень из алюминия
	GN1/1 20(h) mm	GN1/1 40(h) mm	GN1/1 65(h) mm	GN1/1 - 20(h) mm	600 x 400 x 20(h) mm	600 x 400 x 20(h) mm

	AV4940	AVB4940	AV4937	3CLEAN
	Teglia alluminata Aluminium coated tray Plaque en aluminium Aluminium beschichtetes Blech Bandeja aluminad Алюминиевый противень	Teglia alluminio sagomata 5 baguette Shaped aluminium tray for 5 baguettes Plaque en aluminium profilée 5 baguettes Blech aus Aluminium mit Vertiefungen für 5 Baguettes Bandeja de aluminio perfilada para 5 baguette Алюминиевый противень, профилированный 5 багет	Teglia blurex Blurex tray Plaque blurex Blurex-Blech Bandeja de blurex Противень blurex	Detergente tanica Detergent Détergent bidon Reinigungsmittel, Kanister Detergente bidón Моющее средство, канистра
	600 x 400 x 20(h) mm		600 x 400 x 40(h) mm	6 Kg

	GP37	GP38
	<p>Teglia piana in alluminio - Non-stick aluminium flat baking pan Plaque de cuisson plate en aluminium antiadhésif Antihftbeschichtetes flaches Aluminium-Backblech Bandeja de horno plana de aluminio antiadherente Алюминиевый плоский противень с антипригарным покрытием</p>	<p>Teglia in alluminio antiaderente per arrosti e verdure grigliate Non-stick aluminium pan for roasts and grilled vegetables Plaque en aluminium antiadhésive pour les rôtis et les légumes grillés Antihftbeschichtetes Aluminium-Backblech für Braten und gegrilltes Gemüse Bandeja de aluminio antiadherente para asados y verduras a la parrilla Алюминиевый противень антипригарным для приготовления жаркого и овощей на гриле</p>
	GN1/1 - 20(h) mm	
		

	GP65
	<p>Griglia per polli in acciaio inox antiaderente - Non-stick stainless steel grid for chickens Grille à poulets antiadhésive en acier inox - Antihft-Edelstahl-Gitter für Hähnchen Rejilla antiadherente de acero inoxidable para pollos - Антипригарная решетка для кур из нержавеющей стали</p>
	GN1/1
	



Scopri tutti gli accessori su Forcar Multiservice!
 Discover Forcar Multiservice!

CC74GFEV-CC76GFEV
CC74GFG-CC76GFG
CC74G-CC76G-CC74P



CC74G



CC74GFEV



CC76GFG

Cucine

RANGES
CUISINIÈRES
HERDE
COCINAS
ПЛИТЫ

IT Cucine a gas - piano di cottura in acciaio inox AISI 304 - struttura, maniglia e piedi, regolabili in altezza, in acciaio inox AISI 430 - griglie indipendenti - allacciamento gas 1/2"G - bruciatori in ghisa con termocoppia di sicurezza e accensione elettrica, predisposte per metano, kit GPL incluso
CC74GFEV: 4 fuochi a gas + forno elettrico GN1/1 - in dotazione 1 griglia in acciaio cromato.
CC76GFEV: 6 fuochi a gas + forno elettrico GN1/1 + vano a giorno - in dotazione 1 griglia in acciaio cromato, a richiesta con sportelli in acciaio inox.
CC74GFG: 4 fuochi a gas + forno a gas GN1/1 - in dotazione 1 griglia in acciaio cromato.
CC76GFG: 6 fuochi a gas + forno a gas GN1/1 + vano a giorno - in dotazione 1 griglia in acciaio cromato, a richiesta con sportelli in acciaio inox.
CC74G: 4 fuochi a gas + vano a giorno, a richiesta con sportelli in acciaio inox.
CC76G: 6 fuochi a gas + vano a giorno, a richiesta con sportelli in acciaio inox.
CC74P: 4 piastre elettriche da ø 220 mm + vano a giorno, a richiesta con sportelli in acciaio inox.











FR Cuisinières à gaz avec four électrique. Plaque de cuisson en acier Inox AISI 304. Corps, poignée et pieds, réglables en hauteur, en acier inox AISI 430 - grilles indépendantes - raccordement gaz 1/2"G- brûleurs en fonte avec thermocouple de sécurité et allumage électrique, prêts pour gaz naturel, kit GPL inclus.
CC74GFEV: 4 brûleurs à gaz + four électrique GN1/1 - fournis avec 1 grille en acier chromé.
CC76GFEV: 6 brûleurs à gaz + four électrique GN1/1 + élément ouvert - fournis avec 1 grille en acier chromé, sur demande avec portes en acier Inox.
CCF74GFG: 4 brûleurs à gaz+ four à gas GN1/1 - fournis avec 1 grille en acier chromé.
CCF76GFG: 6 brûleurs à gaz+ four à gas GN1/1+ élément ouvert - fournis avec 1 grille en acier chromé, sur demande avec portes en acier inox.
CC74G: 4 brûleurs à gaz + élément neutre, sur demande avec portes en acier inox.
CC76G: 6 brûleurs à gaz + élément neutre, sur demande avec portes en acier inox.
CC74P: 4 plaques électriques ø 220 mm + élément neutre, sur demande avec portes en acier inox.

ES Cocinas a gas con horno eléctrico. Plato de cocción de acero inoxidable AISI 304. Carcasa, mango y patas, regulables en altura, en acero inoxidable AISI 430 - rejillas independientes - conexión de gas 1/2"G - quemadores de hierro fundido con termopar de seguridad y encendido eléctrico, preparados para gas natural, kit GLP incluido - suministrados con 1 rejilla de acero cromado.
CC74GFEV: 4 quemadores de gas + horno eléctrico GN1/1 - suministrados con 1 rejilla de acero cromado.
CC76GFEV: 6 quemadores de gas + horno eléctrico GN1/1 + elemento abierto - suministrados con 1 rejilla de acero cromado, bajo pedido con puertas de acero inoxidable.
CC74GFG: 4 quemadores de gas + horno a gas GN1/1- suministrados con 1 rejilla de acero cromado.
CC76GFG: 6 quemadores de gas + horno a gas GN1/1 + elemento abierto - suministrados con 1 rejilla de acero cromado, bajo pedido con puertas de acero inoxidable.
CC74G: 4 quemadores de gas + elemento Abierto, bajo pedido con puertas de acero inoxidable.
CC76G: 6 quemadores de gas + elemento Abierto, bajo pedido con puertas de acero inoxidable.
CC74P: 4 placas eléctricas ø 220 mm + elemento abierto, bajo pedido con puertas de acero inoxidable.















EN Gas ranges with electric oven. Stainless steel AISI 304 cooking plate. Casing, handle and feet, height adjustable, in stainless steel AISI 430 - independent grids - gas connection 1/2"G - cast iron burners with safety thermocouple and electric ignition, natural gas ready, LPG kit included.
CC74GFEV: 4 gas burners + electric oven GN1/1 - supplied with 1 chromed steel grid.
CC76GFEV: 6 gas burners + electric oven GN1/1 + open element - supplied with 1 chromed steel grid, on request with stainless steel doors.
CC74GFG: 4 gas burners + gas oven GN1/1- supplied with 1 chromed steel grid.
CC76GFG: 6 gas burners + gas oven GN1/1 + open element - supplied with 1 chromed steel grid, on request with stainless steel doors.
CC74G: 4 gas burners + open element, on request with stainless steel doors.
CC76G: 6 gas burners + open element, on request with stainless steel doors.
CC74P: 4 electric plates ø 220 mm + open element, on request with stainless steel doors.

DE Gasherde mit elektrischem Backofen. Kochplatte aus Edelstahl AISI 304. Gehäuse, Griff und Füße, höhenverstellbar, aus Edelstahl AISI 430 - unabhängige Gitter - Gasanschluss 1/2"G- Gussbrenner mit Sicherheitsthermoelement und elektrischer Zündung, erdgasbereit, LPG-Kit im Lieferumfang enthalten - geliefert mit 1 verchromten Stahlgitter.
CC74GFEV: 4 Gasbrenner + Elektrobackofen GN1/1- geliefert mit 1 verchromten Stahlgitter.
CC76GFEV: 6 Gasbrenner + Elektrobackofen GN1/1 + offenes Element - geliefert mit 1 verchromten Stahlgitter, auf Wunsch mit Edelstahltüren.
CC74GFG: 4 Gasbrenner + Gasofen GN1/1- geliefert mit 1 verchromten Stahlgitter.
CC76GFG: 6 Gasbrenner + Gasofen GN1/1 + offenes Element - geliefert mit 1 verchromten Stahlgitter, auf Wunsch mit Edelstahltüren.
CC74G: 4 Gasbrenner + offenes Element, auf Wunsch mit Edelstahltüren.
CC76G: 6 Gasbrenner + offenes Element, auf Wunsch mit Edelstahltüren.
CC74P: 4 Elektroplatten ø 220 mm + offenes Element, auf Wunsch mit Edelstahltüren.

RU Газовых кухни с электрической духовкой. Варочная панель из нержавеющей стали AISI 304 - "Электрические плиты с духовкой". конструкция, ручка и ножки, регулируемые по высоте, из нержавеющей стали AISI 430 - решетки независимые - газовое соединение 1/2"G - чугунные горелки с термопарой безопасность и электрическое зажигание, приготовленные для метана, комплект для сжиженного природного газа входит в комплект поставки - в комплектации поставляется с.
CC74GFEV: 4 газовые горелки + электрическая печь GN1/1 - 1 решеткой из хромированной стали.
CC76GFEV: 6 газовых горелок + электрическая печь GN1/1 + открытый отсек - по запросу. с дверями из нержавеющей стали - 1 решеткой из хромированной стали.
CC74GFG: 4 газовые горелки + газовая печь GN1/1- 1 решеткой из хромированной стали.
CC76GFG: 6 газовых горелок + газовая печь GN1/1 + открытый элемент, с дверцами из нержавеющей стали по запросу - 1 решеткой из хромированной стали.
CC74G: 4 газовые горелки + открытый элемент - с дверцами из нержавеющей стали по запросу.
CC76G: 6 газовых горелок + открытый элемент - с дверцами из нержавеющей стали по запросу.
CC74P: 4 электрические пластины ø 220 mm + открытый элемент - с дверцами из нержавеющей стали по запросу.

	CC74GFEV con forno elettrico / with electric oven	CC76GFEV con forno elettrico / with electric oven	CC74GFG con forno a gas / with gas oven	CC76GFG con forno a gas / with gas oven
	3 kW (Forno - Oven - Печь)		4 kW (Forno - Oven - Печь)	
	19 kW (Top - Top power - мощность плиты)	28,5 kW (Top - Top power - мощность плиты)	19 kW (Top - Top power - мощность плиты)	28,5 kW (Top - Top power - мощность плиты)
 1 Ph	230V/1N/50-60Hz			
	50±275°C			
	Meccanico - Mechanical - Механический 0÷120'			
kcal/h BTU/h	18916 kcal/h 75065 BTU/h	27085 kcal/h 107482 BTU/h	19777 kcal/h 78478 BTU/h	22356 kcal/h 88713 BTU/h
METANO METHANE МЕТАНА	G20/25 = 2,00 m³/h	G20/25 = 3,00 m³/h	G20/25 = 2,43 m³/h	G20/25 = 3,44 m³/h
GPL LPG	G30/31 = 1,50 Kg/h	G30/31 = 2,25 Kg/h	G30/31 = 1,80 Kg/h	G30/31 = 2,56 Kg/h
	4 x GN1/1 638 x 394 x 356(h) mm		4 x GN1/1 635 x 354 x 390(h) mm	
 mm	800 x 700 x 900(h) mm	1200 x 700 x 900(h) mm	800 x 700 x 900(h) mm	1200 x 700 x 900(h) mm
				
 NET Kg	72 Kg	91 Kg	75 Kg	94 Kg
 GROSS Kg	82 Kg	105 Kg	85 Kg	108 Kg
 mm	860 x 760 x 915(h) mm	1260 x 760 x 915(h) mm	860 x 760 x 915(h) mm	1260 x 760 x 915(h) mm
 m³	0,600 m³	0,871 m³	0,595 m³	0,871 m³

Con sportelli in acciaio inox - With stainless steel doors - Avec portes en acier Inox
Mit Edeltahlüren - Con puertas de acero inoxidable - С дверями из нержавеющей стали

	CC74G senza forno / without oven	CC76G senza forno / without oven	CC74P piastre elettriche electric plates
	-		10,4 kW
	19 kW	28,5 kW	
	-		400V/3N/50-60Hz
	230V/1N/50-60Hz		-
	16337 Kcal/h 64830 BTU/h	24505 Kcal/h 97244 BTU/h	-
	G20/25 = 2,00 m³/h	G20/25 = 3,00 m³/h	-
	G30/31 = 1,50 Kg/h	G30/31 = 2,25 Kg/h	-
	800 x 700 x 900(h) mm	1200 x 700 x 900(h) mm	800 x 700 x 900(h) mm
	-		
	62 Kg	94 Kg	55 Kg
	72 Kg	108 Kg	65 Kg
	860 x 760 x 915(h) mm	1260 x 760 x 915(h) mm	860 x 760 x 915(h) mm
	0,600 m³	0,871 m³	0,595 m³

Con sportelli in acciaio inox - With stainless steel doors
 Avec portes en acier Inox - Mit Edelstahltüren
 Con puertas de acero inoxidable - С дверями из нержавеющей стали

Potenza - Power - Puissance - Leistung - Potencia - Мощность

CC74GFEV CC74GFG - CC74G		CC76GFEV - CC76GFG CC76G			CC74P	
6 kW	3,5 kW	6 kW	3,5 kW	6 kW	2,6 kW ø220 mm	2,6 kW ø220 mm
3,5 kW	6 kW	3,5 kW	6 kW	3,5 kW	2,6 kW ø220 mm	2,6 kW ø220 mm



CC76G



CC74P

FR4N-FR44N
FR8N-FR88N
FR8RN-FR88RN
FR10RN-FR1010RN



FR8N



FR44N

Friggitrici elettriche

ELECTRIC FRYERS
FRITEUSES ÉLECTRIQUES
ELEKTRISCHE FRITEUSEN
FREIDORAS ELÉCTRICAS
ЭЛЕКТРИЧЕСКИЕ ФРИТЮРНИЦЫ

IT Modelli da banco. Struttura, vasca e coperchio in acciaio inox AISI 304 - cestelli a rete estraibili in filo cromato - manici cestelli e pomelli coperchi in plastica termoisolante - resistenze inox - termostato di sicurezza con pulsante di ripristino - versioni a due vasche con doppio termostato per utilizzo indipendente - testata e resistenze removibili.
I modelli FR4 raggiungono i 180°C in circa 10 minuti.
I modelli FR8 raggiungono i 180°C in circa 18 minuti tempo di frittura in circa 7 minuti.
I modelli FR8RN e FR88RN sono dotati di rubinetti di sicurezza.
I modelli FR10 raggiungono i 180°C in circa 12 minuti, tempo di frittura in circa 5 minuti, dotati di rubinetti di sicurezza - griglie di supporto incluse.

FR Modèles de table. Corps, cuve et couvercle en acier inox AISI 304 - paniers amovibles en fil chromé - poignées et pommeaux des paniers en matériau thermo-isolant - résistance en acier inox - thermostat de sécurité avec bouton de remise à zéro - versions à deux cuves avec double thermostat pour une utilisation indépendante - collecteur et résistances amovibles.
Les modèles FR4 atteignent 180°C en 10 minutes environ.
Les modèles FR8 atteignent 180°C en environ 18 minutes temps de friture de 7 minutes environ.
Les modèles FR10 atteignent 180°C en 12 minutes environ, le temps de friture en 5 minutes environ et sont équipés de robinets de sécurité - y compris de grilles de support.

ES Modelos de sobremesa. Carcasa, cuba y tapa de acero inoxidable AISI 304 - cestas desmontables de alambre cromado - asas de cestas y tapas de material termoaislante - resistencias de acero inoxidable - termostato de seguridad con pulsador de rearme - versiones de dos cubas con doble termostato de uso independiente - cabezal y resistencias desmontables.
Los modelos FR4 alcanzan los 180°C en unos 10 minutos.
Los modelos FR8 alcanzan los 180°C en unos 18 minutos de fritura en unos 7 minutos.
Los modelos FR10 alcanzan los 180°C en unos 12 minutos, el tiempo de fritura en unos 5 minutos y están equipados con grifos de seguridad, incluidas rejillas de apoyo.

EN Table-top models. Casing, bowl and lid in AISI 304 stainless steel - removable baskets in chrome-plated wire - baskets handles and lids knobs in thermo-insulating material - stainless steel heating elements - safety thermostat with reset button - two-bowls versions with double thermostat for independent use - header and heating element removable.
FR4 models reach 180°C in about 10 minutes.
FR8 models reach 180°C in about 18 minutes frying time in about 7 minutes.
The FR10 models reach 180°C in about 12 minutes, frying time in about 5 minutes and are equipped with safety taps - including support grids.

DE Tischmodelle. Gehäuse, Wanne und Deckel aus Edelstahl AISI 304 - abnehmbare Körbe aus verchromtem Draht - Korbgriffe und Deckelknöpfe aus wärmeisolierendem Material - Heizelemente aus Edelstahl - Sicherheitsthermostat mit Rückstellknopf - Zwei-Wanne - Versionen mit Doppelthermostat für den unabhängigen Gebrauch - Kopfteil und abnehmbare Heizelement.
FR4-Modelle erreichen 180°C in etwa 10 Minuten.
FR8-Modelle erreichen 180°C in etwa 18 Minuten Frittierzeit von etwa 7 Minuten.
FR10-Modelle erreichen 180°C in etwa 12 Minuten, Frittierzeit von etwa 5 Minuten und sind mit Sicherheitsarmaturen ausgestattet - inklusive Stützgitter.

RU Настольные модели. Корпус, чаша и крышка из нержавеющей стали AISI 304 - съемные корзины из хромированной проволоки - ручки корзин и крышек из термоизоляционного материала - резисторы из нержавеющей стали - предохранительные термостаты. с кнопкой сброса - версии с двумя барабанами и независимым двойным термостатом - головной и съемными нагревательными элементами.
Модели FR4 достигают 180°C примерно за 10 минут.
Модели FR8 достигают 180°C примерно за 18 минут времени обжарки примерно за 7 минут.
Модели FR10 достигают 180°C примерно за 12 минут, времени обжарки примерно за 5 минут и оснащены защитными кранами - в том числе опорными решетками.





	FR4N	FR44N	FR8N	FR8RN con rubinetti di sicurezza with safety valves	FR88N	FR88RN con rubinetti di sicurezza with safety valves
	2,5 kW	2,5 + 2,5 kW	3 kW		3 + 3 kW	
 1 Ph	230V/1N/50-60Hz					
	50±180°C					
 Kg/h	4,5 Kg/h	4,5 + 4,5 Kg/h	8 Kg/h		8 + 8 Kg/h	
	6 L	6 + 6 L	10 L		10 + 10 L	
	min. 3 L / max. 4 L	min. 3 L / max. 4 L cad.	min. 6 L / max. 8 L		min. 6 L / max. 8 L cad.	
	0,5 Kg	0,5 + 0,5 Kg	1 Kg		1 + 1 Kg	
 mm	175 x 425/570 x 320(h) mm	380 x 425/570 x 320(h) mm	265 x 425/600 x 360(h) mm	265 x 470/600 x 360(h) mm	565 x 425/600 x 360(h) mm	565 x 470/600 x 360 (h) mm
						
 NET Kg	4,5 Kg	8,5 Kg	7,5 Kg		15 Kg	
 GROSS Kg	5 Kg	9,5 Kg	8 Kg		16,5 Kg	
 mm	250 x 505 x 365(h) mm	426 x 505 x 365(h) mm	331 x 505 x 405(h) mm		635 x 505 x 405(h) mm	
 m³	0,045 m³	0,085 m³	0,067 m³		0,124 m³	

GRIFR8

Griglia supporto cestello - Basket support grids
сетки поддержки корзины

Mod.

FR8N - FR8RN

	FR10RN con rubinetti di sicurezza with safety valves	FR1010RN con rubinetti di sicurezza with safety valves
	6 kW	6 + 6 kW
 3 Ph	400V/3N/50-60Hz	
	50±180°C	
 Kg/h	11 Kg/h	11 + 11 Kg/h
	12 L	12 + 12 L
	min. 8 L / max. 10 L	min. 8 L / max. 10 L cad.
	1,25 Kg	1,25 + 1,25 Kg
 mm	265 x 520/650 x 360(h) mm	565 x 520/650 x 360 (h) mm
		
 Kg	8,5 Kg	17 Kg
 Kg	10 Kg	19 Kg
 mm	561 x 338 x 405(h) mm	630 x 557 x 410(h) mm
 m³	0,750 m³	0,172 m³



FR1010RN

OPTIONAL



SFM18
SFM18D



SFM18



SFM18D

Friggitrici elettriche

18 L

ELECTRIC FRYERS
FRITEUSES ÉLECTRIQUES
ELEKTRISCHE FRITEUSEN
FREIDORAS ELÉCTRICAS
ЭЛЕКТРИЧЕСКИЕ ФРИТЮРНИЦЫ

IT Friggitrici da 18 L. Dotate di mobile - struttura, vasche, coperchi, cestelli e resistenze in acciaio inox AISI 304 - manici cestelli e pomelli coperchi in materiale isolante - termostato di sicurezza con pulsante di ripristino - dotate di un cestello grande - rubinetto scarico e bacinella raccogli olio con filtro e beccuccio in acciaio inox - resistenze ribaltabili - reti protezione in vasca. Il modello SFM18D ha due vasche con doppio termostato per utilizzo indipendente. Raggiungono i 190°C in circa 6 minuti, tempo di frittura in circa 5 minuti.















EN 18 L fryer. On neutral element - casing, bowls, lids, baskets and resistances in stainless steel AISI 304 - basket handles and knobs in insulating material - safety thermostat with reset button - equipped with a large basket - drain valve and oil collecting basin with stainless steel filter and nozzle - tilting heating elements - protection nets in the bowl. The model SFM18D has two bowls with double thermostat for independent use. It reaches 190°C in about 6 minutes, frying time in about 5 minutes.

FR Friteuses capacité 18 L Sur meuble neutre -corps, cuve, couvercle, paniers et résistances en acier inox AISI 304 - poignées et pommeaux des paniers en matériau thermo-isolant - thermostat de sécurité avec bouton de réarmement équipé d'un grand panier - vanne de vidange et bac collecteur d'huile avec filtre et buse en acier inoxydable - Résistances basculantes - grilles de protection dans la cuve. Le modèle SFM18D dispose de deux cuves avec double thermostat pour une utilisation indépendante. Ils atteignent 190°C en environ 6 minutes temps de friture de 5 minutes environ.

DE Friteusen Kapazität 18 L Auf neutral Element -Gehäuse, Wanne, Deckel, Körbe und Heizkörper aus Edelstahl AISI 304 - Korbgriffe und Deckelknöpfe aus wärmeisolierendem Material - Sicherheitsthermostat mit Resetknopf - ausgestattet mit einem großen Korb - Ablasshahn und Ölwanne mit Filter und Düse aus Edelstahl - Kippheizelement - Schutznetze im Becken. Das Modell SFM18D verfügt über zwei Becken mit Doppelthermostat für den unabhängigen Einsatz. Erreicht 190°C in etwa 6 Minuten Frittierzeit von etwa 5 Minuten.

ES Freidora de 18 litros. Equipado con armario - estructura, depósitos, tapas, cestas y resistencias en acero inoxidable AISI 304 - asas y pomos tapas en material aislante - termostato de seguridad con pulsador de rearme - equipado con una gran cesta - grifo de vaciado y bandeja de aceite con filtro y boquilla en acero inoxidable - resistencias basculantes - redes de protección en el depósito. El modelo SFM18D dispone de dos depósitos con doble termostato para uso independiente. Alcanzando 190°C in unos 6 minutos, tiempo de freír en unos 5 minutos.

RU 18-литровая жаровня для жарки во фритюре. Оснащен шкафом - конструкция, баки, крышки, корзины и сопротивления из нержавеющей стали AISI 304 - ручки и ручки крышки из изоляционного материала - предохранительный термостат с кнопкой сброса - оснащен большой корзиной - сливной кран и масляный поддон с фильтром и соплом из нержавеющей стали - сопротивление опрокидыванию - защитные сетки в баке. Модель SFM18D имеет два бака с двойным термостатом для самостоятельного использования. Температура достигает 190°C примерно за 6 минут, время обжарки - примерно за 5 минуты.

	SFM18	SFM18D
	11,5 kW	11,5 + 11,5 kW
	400V/3N/50-60Hz	
	50±195°C	
	30 Kg/h	60 Kg/h
	22 L	22 + 22 L
	18 L	18 + 18 L
	2,5 Kg	2,5 + 2,5 Kg
	400 x 700 x 978(h) mm	800 x 700 x 978(h) mm
		
	40 Kg	72 Kg
	51 Kg	85 Kg
	470 x 800 x 1210(h) mm	870 x 800 x 1210(h) mm
	0,455 m³	0,842 m³

SF25P



SF25P

Friggitrici elettriche

25 L per pasticceria

ELECTRIC FRYERS
FRITEUSES ÉLECTRIQUES
ELEKTRISCHE FRITEUSEN
FREIDORAS ELÉCTRICAS
ЭЛЕКТРИЧЕСКИЕ ФРИТЮРНИЦЫ

IT Friggitrice da 25 L per pasticceria. Modello da banco - struttura, vasca, coperchio, cestello e resistenze in acciaio inox AISI 304 - manici cestelli e pomelli coperchi in materiale isolante - termostato di sicurezza con pulsante di ripristino - testata e resistenze removibili - rubinetto di sicurezza esterno con sistema di scarico a innesto frontale a baionetta - dotata di un cestello grande. Raggiunge i 180°C in circa 16 minuti, tempo di frittura in circa 6 minuti.















EN 25 L fryer for pastry. Counter-top model - casing, tank, lid, basket and heating elements in stainless steel AISI 304 - basket handles and knobs in insulating material - safety thermostat with reset button - removable head and heating elements - external safety tap with bayonet frontal plug-in discharge system - equipped with a large basket. It reaches 180°C in about 16 minutes, frying time in about 6 minutes.

FR Friteuse de 25 L pour pâtisserie. Modèle de comptoir - corps, cuve, couvercle, panier et éléments chauffants en acier inox AISI 304 - poignées et boutons en matériau isolant - thermostat de sécurité avec bouton de réinitialisation - tête et éléments chauffants amovibles - robinet de sécurité externe avec système de déchargement frontal à baïonnette - équipé d'un grand panier. Il atteint 180°C en 16 minutes environ, le temps de friture en 6 minutes environ.

DE 25 L Fritteuse für Konditorei. Tischmodell - Gehäuse, Tank, Deckel, Korb und Heizelemente aus Edelstahl AISI 304 - Korbgriffe und - knöpfe aus Isolierstoff - Sicherheitsthermostat mit Rückstellknopf - abnehmbarer Kopf und Heizelemente - externer Sicherheitshahn mit Bajonett-Stecksystem - ausgestattet mit einem großen Korb. Erreicht 180°C in ca. 16 Minuten, Frittierzeit ca. 6 Minuten.

ES Freidora de 25 litros para pastelería. Modelo de mostrador - carcasa, depósito, tapa, cesta y elementos calefactores en acero inoxidable AISI 304 - manijas y pomos de cesta en material aislante - termostato de seguridad con pulsador de rearme - cabezal y elementos calefactores extraíbles - grifo de seguridad externo con sistema de descarga frontal de bayoneta - equipado con una cesta grande. Alcanza los 180°C en unos 16 minutos y se frie en unos 6 minutos.

RU Фритюрница на 25 литров для выпечки кондитерских изделий. Модель столешницы - корпус, бак, крышка, корзина и нагревательные элементы из нержавеющей стали AISI 304 - ручки и ручки корзины из изоляционного материала - предохранительный термостат с кнопкой сброса - съемная головка и нагревательные элементы - внешний предохранительный кран с байонетным передним сливом - оснащен большой корзиной. Температура достигает 180°C примерно за 16 минут, время обжарки - около 6 минут.

	SF25P
	9 kW
	400V/3N/50-60Hz
	50÷180°C
	45 Kg/h
	29 L
	25 L
	7 Kg
	585 x 660 x 440(h) mm
	
	22,5 Kg
	26 Kg
	660 x 730 x 480(h) mm
	0,231 m³

SF10M-SF10DM
SFM20M-SFM20DM



SFM20M



SFM20DM

Friggitrici a gas
10 - 20 L

GAS FRYERS
FRITEUSES À GAZ
GAS FRITEUSEN
FREIDORAS A GAS
ГАЗОВЫЕ ФРИТЮРНИЦЫ

IT Friggitrici a gas. Struttura, coperchi, cestelli e resistenze in acciaio inox AISI 304 - piano di lavoro e vasche stampate in acciaio inox spessore 15/10 - manici, cestelli, pomelli e coperchi in materiale isolante - allacciamento gas 1/2"G - termostato a 7 posizioni da 110÷190°C - bruciatori inox tubulari con sistema turbolatore che rallenta il flusso della fiamma aumentando la resa di circa il 50%, combustione ottimizzata con valvola termocoppia e termostato di sicurezza - fiamma pilota protetta - accensione con piezoelettrico - alimentazione a metano, in dotazione kit GPL - rubinetto scarico - dotate di un cestello grande. Raggiungono i 190°C in circa 10 minuti. Modelli SF10DM - SFM20DM con due vasche e doppio termostato per utilizzo indipendente. SF10M-SF10DM: modelli da 10 L sono da banco.

FR Corps, couvercles, paniers et éléments chauffants en acier inox AISI 304 - plan de travail et cuves moulées en acier inox épaisseur 15/10 - poignées et boutons de panier en matériau isolant - raccord gaz 1/2"G - thermostat 7 positions de 110÷190°C - brûleurs tubulaires en acier inox avec système turbulateur qui ralentit le flux de la flamme en augmentant son rendement de 50% environ, allumage avec thermocouple et thermostat de sécurité - flamme pilote protégée - allumage à piézoélectrique - livrée à gaz naturel avec kit LPG - robinet de vidange - grand panier équipé avec un thermostat. Elle atteint 190°C en 10 minutes environ. Modèle SF10DM - SFM20DM avec deux cuves avec double thermostat pour une utilisation indépendante. SF10M-SF10DM: modèles de table.

ES Estructura, tapas, cestas y elementos calefactores en acero inoxidable AISI 304 - encimera y depósitos moldeados en acero inoxidable espesor 15/10 - asas y pomos de cesta con material aislante - conexión a gas 1/2"G - termostato de 7 posiciones de 110÷190°C - quemadores tubulares en acero inoxidable con sistema de turbulador que ralentiza el flujo de la llama aumentando el rendimiento en un 50% aproximadamente, combustión optimizada con termostato de seguridad y termostato - llama piloto protegida - llama piloto - ignición piezoeléctrica - alimentación de gas natural - con kit de GPL - llave de desagüe - provisto de un amplio recipiente de drenaje. Alcanza los 190°C en unos 10 minutos. Modelo SF10DM - SFM20DM con dos bols con doble termostato para uso independiente. SF10M-SF10DM: Modelos de sobremesa.

EN Structure, lids, baskets and heating elements in stainless steel AISI 304 - moulded worktop and bowls in stainless steel thickness 15/10 - basket handles and knobs with insulating material - 1/2"G gas connection - 7 position thermostat 110÷190°C - stainless steel tubular burners with turbulator system that slows down the flow of the flame increasing the yield by about 50%, combustion optimized with safety thermocouple and thermostat - protected pilot flame - ignition with piezoelectric - natural gas supply, supplied with LPG kit - drain tap - equipped with a large basket. It reaches 190°C in about 10 minutes. Model SF10DM - SFM20DM with two bowls and double thermostat for independent use. SF10M-SF10DM: Table-top models.

DE Gehäuse, Deckel, Körbe und Heizelemente aus Edelstahl AISI 304 - Arbeitsplatte und geformte Wannen aus Edelstahl 15/10 - Korbgriffe und -knöpfe mit Isoliermaterial - 1/2"G Gasanschluss - 7-stufiger Thermostat 110÷190°C - Edelstahlrohrbrenner mit Turbulatorsystem, das den Flammenfluss verlangsamt und die Ausbeute um ca. 50% erhöht, Verbrennung optimiert mit Sicherheitselement und Thermostat - geschützte Pilotflamme - Zündung mit Piezo - Erdgasversorgung, geliefert mit LPG-Kit - Ablasshahn - ausgestattet mit einem großen Korb. Erreicht 190°C in ca. 10 Minuten. Das Modell SF10DM - SFM20DM verfügt über zwei Wannen mit Doppelthermostat für den unabhängigen Einsatz. SF10M-SF10DM: Tischmodelle.

RU Конструкция, крышки, корзины и нагревательные элементы из нержавеющей стали AISI 304 - столешница и формованные баки из нержавеющей стали толщиной 15/10 - ручки и ручки с изоляционным материалом - подключение газа 1/2"G - 7-позиционный термостат от 110 до 190°C - трубчатые горелки из нержавеющей стали с турбулизатором, замедляющим поток пламени, увеличивающим выход примерно на 50%, сжигание, оптимизированное с помощью предохранительной термопары - газовый клапан Р, защищенный на 50°C - электростатами. Температура достигает 190°C примерно за 10 минут. Модель SF10DM - SFM20DM имеет два бака с двойным термостатом для самостоятельного использования. SF10M-SF10DM: Настольные модели.



SF10M



SF10DM

	SF10M	SF10DM	SFM20M	SFM20DM
	6,9 kW	6,9 + 6,9 kW	16,5 kW	16,5 + 16,5 kW
	5934 kcal/h 23543 BTU/h	5934 + 5934 kcal/h 23543 + 23543 BTU/h	14190 kcal/h 56300 BTU/h	14190 + 14190 kcal/h 56300 + 56300 BTU/h
	G20 = 0,73 m ³ /h G25 = 0,85 m ³ /h	G20 = 0,73 + 0,73 m ³ /h G25 = 0,85 + 0,85 m ³ /h	G20 = 1,75 m ³ /h G25 = 2,03 m ³ /h	G20 = 1,75 + 1,75 m ³ /h G25 = 2,03 + 2,03 m ³ /h
	G30/G31 = 0,53 Kg/h	G30/G31 = 0,53 + 0,53 Kg/h	G30/G31 = 1,29 Kg/h	G30/G31 = 1,29 + 1,29 Kg/h
	N° 2 (Bruciatori - Burners - горелки)	N° 2 + 2 (Bruciatori - Burners - горелки)	N° 3 (Bruciatori - Burners - горелки)	N° 3 + 3 (Bruciatori - Burners - горелки)
	12 Kg/h	12 + 12 Kg/h	25 Kg/h	25 + 25 Kg/h
	13 L	13 + 13 L	24 L	24 + 24 L
	10 L	10 + 10 L	20 L	20 + 20 L
	1 Kg	1 + 1 Kg	2,5 Kg	2,5 + 2,5 Kg
	400 x 700 x 370(h) mm	800 x 700 x 370(h) mm	400 x 700 x 980(h) mm	800 x 700 x 980(h) mm
				
	24 Kg	41 Kg	47 Kg	83 Kg
	31 Kg	55 Kg	57 Kg	98 Kg
	480 x 780 x 600(h) mm	880 x 800 x 600(h) mm	480 x 780 x 1200(h) mm	880 x 800 x 1200(h) mm
	0,225 m ³	0,423 m ³	0,449 m ³	0,845 m ³

Optional

ACCESSORIES
ACCESSOIRES
ZUBEHÖR
ACCESORIOS
AKCECCYAPЫ

Friggitrici elettriche - Electric fryers - Friteuses électriques Elektrofritteusen - Freidoras eléctricas - Электрические фритюрницы							Friggitrici a gas - Gas fryers - Friteuses a gaz Gasfritteusen - Freidoras a gas - Газовые фритюрницы			
Mod.	FR4N FR44N	FR8N FR88N FR88RN FR88RN	FR10RN FR1010RN	SFM18 SFM18D	SFM18 SFM18D	SF25P	SF10 SF10DM	SF10M SF10DM	SFM20M SFM20DM	SFM20M SFM20DM
				standard 1 cesto 1 basket	optional 2 mezzi cesti 2 half baskets	standard 1 cesto 1 basket	standard 1 cesto 1 basket	optional 2 mezzi cesti 2 half baskets	standard 1 cesto 1 basket	optional 2 mezzi cesti 2 half baskets
A	415 mm	430 mm	455 mm	545 mm		-	550 mm		545 mm	
B	235 mm	250 mm	275 mm	315 mm		480 mm	300 mm		360 mm	
C	180 mm			210 mm		55x2 mm	190 mm		180 mm	
D	135 mm	210 mm		270 mm	124 mm	450 mm	245 mm	110 mm	280 mm	135 mm
E	100 mm	110 mm		115 mm		125 mm	115 mm		150 mm	
F	200 mm			255 mm		265 mm	210 mm		220 mm	
G	320 mm		370 mm	-						
H	200 mm	210 mm		215 mm		-	210 mm		250 mm	
I	299 mm		348 mm	400 mm		-	345 mm		405 mm	
L	170 mm	260 mm								
M	149 mm	238 mm		300 mm		-	260 mm		300 mm	

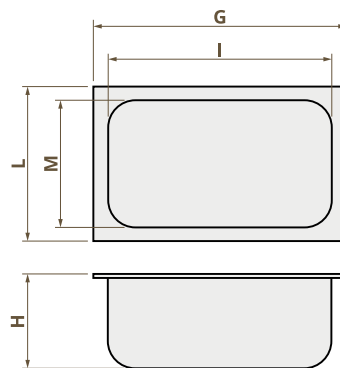
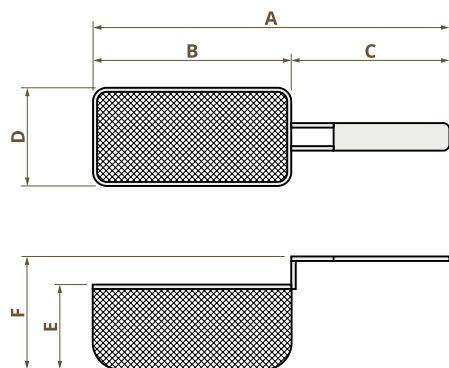

	ACSFM10	ACMCSFM20M
	1 mezzo cesto - 1 half basket - 1 demi panier 1 halber Korb - 1 cesta pequeña - 1 полу-корзина	
Mod.	SF10M SF10DM	SFM20M - SFM20DM SFM18 - SFM18D

SFM18

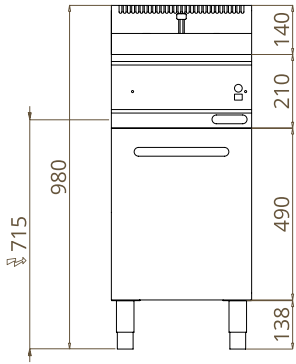

SFM18D

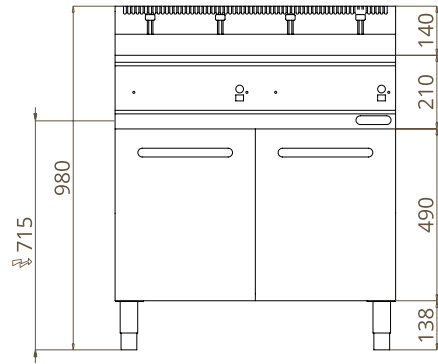

SFM20M

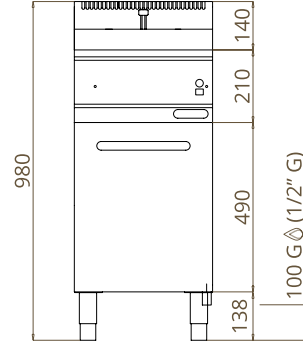

SFM20DM

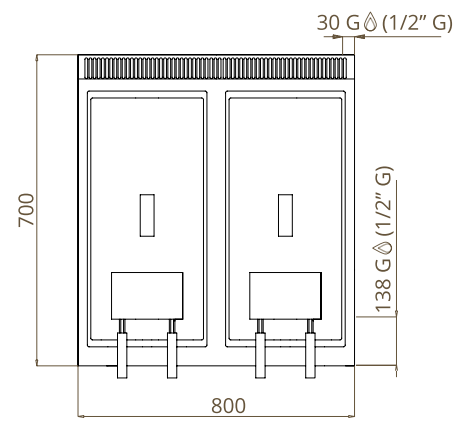
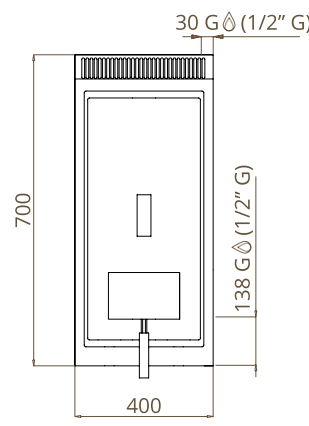
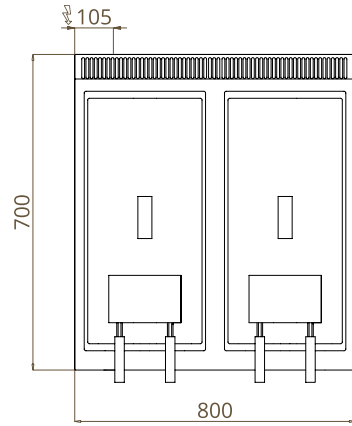
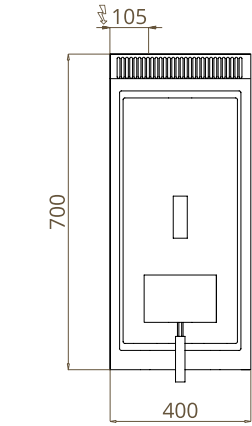
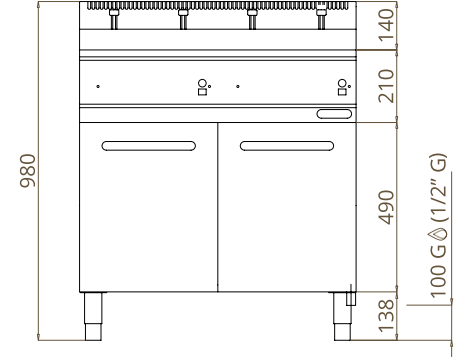

SF25P

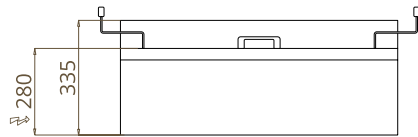

SF10M

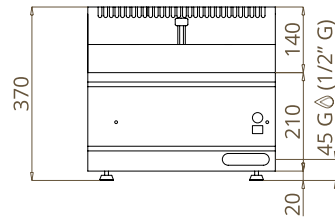

SF10DM

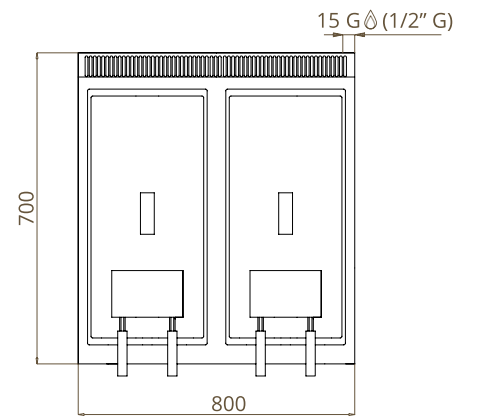
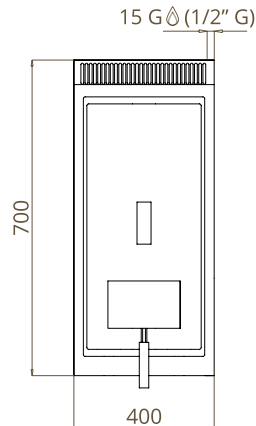
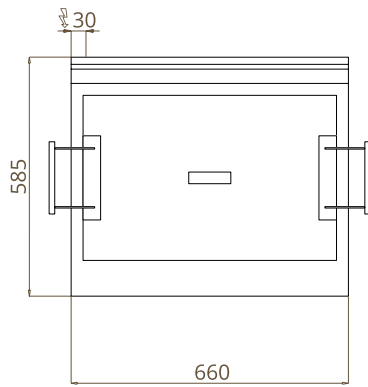
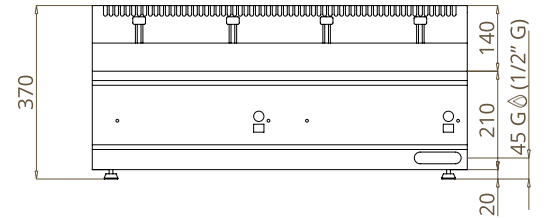

FR4N

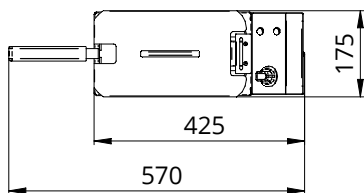
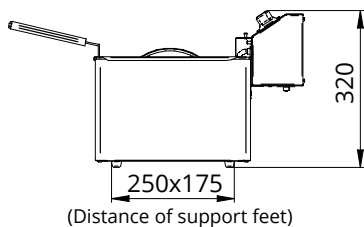

FR8N

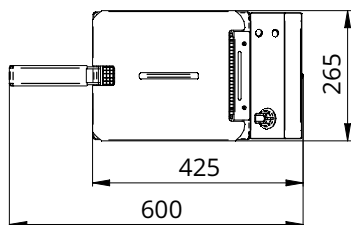
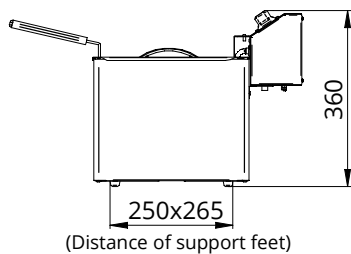

FR8RN

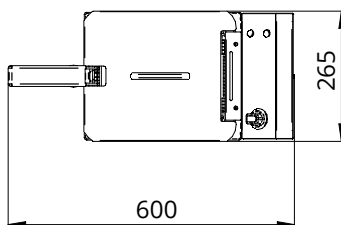
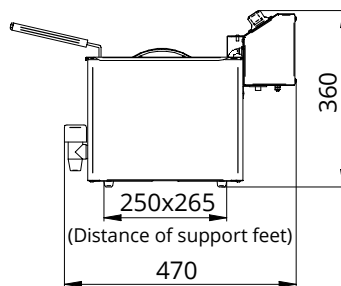

FR10RN

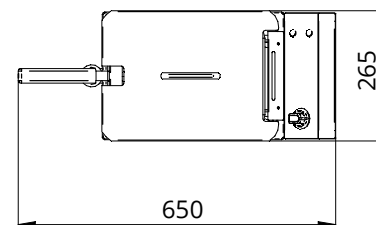
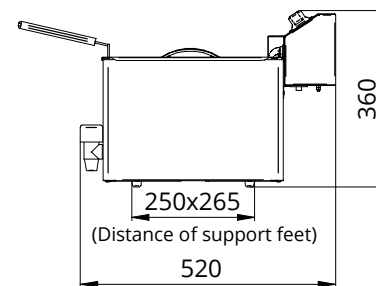

FR44N

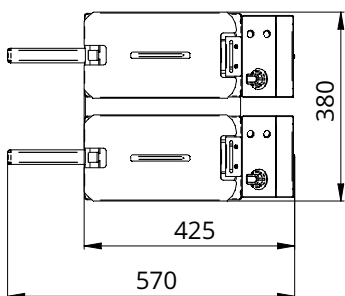
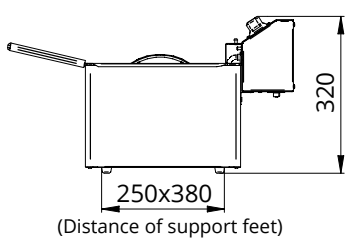

FR88N

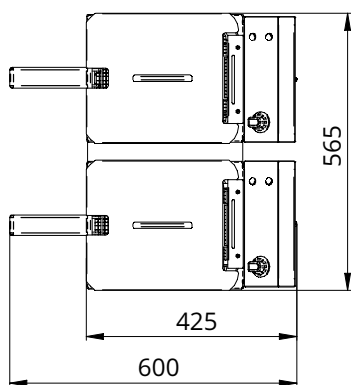
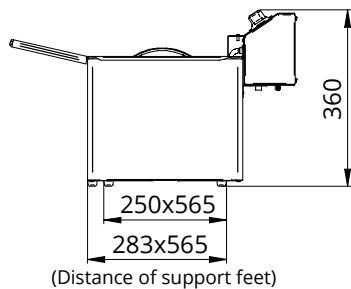

FR88RN

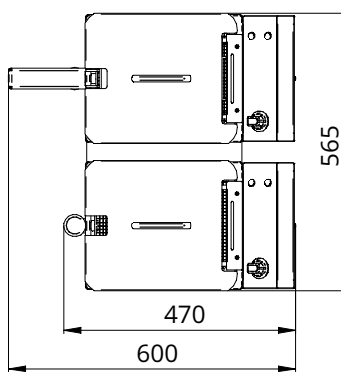
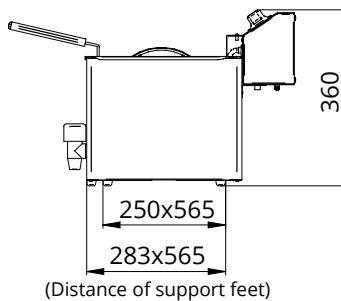

FR1010RN

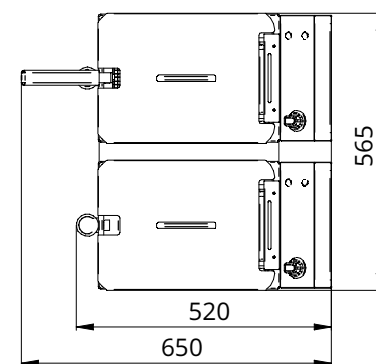
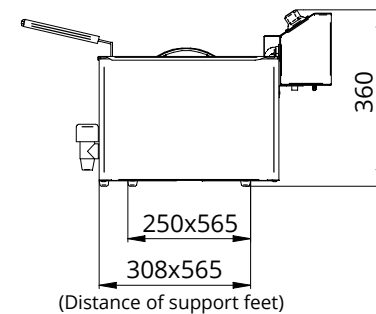

CP11N
CPM30



CPM30



CP11N

Cuocipasta elettrici

ELECTRIC PASTA COOKERS
CUISEURS À PÂTE ÉLECTRIQUES
ELEKTRO NUDELKOCHER
COCEDORES DE PASTA ELÉCTRICOS
ЭЛЕКТРИЧЕСКИЕ МАКАРОНОВАРКИ

IT Cuocipasta elettrici. Struttura e cestelli in acciaio inox - vasca in acciaio inox AISI 316 spessore 15/10 - manici cestelli in materiale isolante - resistenze corazzate in acciaio inox incoloy - rubinetto carico acqua collegabile alla rete - rubinetto di sicurezza esterno - camino rialzato con funzione paraspruzzi. Il modello CPM30 è dotato di mobile, ha sistema di scarico collegato alla rete e sistema a sfioramento per eliminare i residui di deposito di amido della pasta. Il modello CP11N è da banco, dotato di sistema di scarico a innesto frontale a baionetta e coppia di cestelli piccoli.

EN Electric pasta cooker. Casing and baskets in stainless steel - bowl in stainless steel AISI 316 thickness 15/10 - basket handles in insulating material - armored heating elements in stainless steel incoloy - water loading tap connectable to the network - external safety valve - raised chimney with backsplash function. The CPM30 model is equipped with neutral element, a drainage system connected to the network and a touch system to remove pasta starch deposits - the mod. CP11N is a counter model and comes with a frontal bayonet coupling drain system and pair of small containers.

FR Cuiseur de pâtes électrique. Corps et paniers en acier inox - cuve en acier inox AISI 316 épaisseur 15/10 - poignées en matériau isolant - éléments chauffants renforcés en acier inox incoloy - robinet de chargement d'eau raccordable au réseau - soupape de sécurité externe - cheminée haute avec fonction de dossier. Le modèle CPM30 est équipé d'un élément neutre, d'un système de drainage relié au réseau et d'un système tactile pour éliminer les dépôts d'amidon des pâtes -le mod. CP11N est un modèle de comptoir et est muni de système de vidange à amorce frontale à baïonnette et paire de petits paniers.

DE Elektrischer Nudelkocher. Gehäuse und Körbe aus Edelstahl - Wanne aus Edelstahl AISI 316 Schichtdicke 15/10 - Korbgriffe aus Isoliermaterial - verstärkte Heizelemente aus Edelstahl incoloy - Wasserladeventil netzwerkfähig - externes Sicherheitsventil - erhöhter Kamin mit Aufkantung. Das Mod CPM30 ist mit einem neutralen Element, einem an das Netzwerk angeschlossenen Drainagesystem und einem Touch-System zum Entfernen von Pastastärkeablagerungen ausgestattet. - das Mod. CP11N ist für einen Tresen vorgesehen und ist mit einem Ablasssystem mit Frontal-Bajonettverschluss ausgestattet und ein paar kleiner Körbe.

ES Cocedor de pasta eléctrico. Carcasa y cestas de acero inoxidable - cuba de acero inoxidable AISI 316 espesor 15/10 - mangos de cesta de material aislante - elementos calefactores reforzados de acero inoxidable - grifo de carga de agua conectable a la red - válvula de seguridad externa - chimenea elevada con función backsplash. El modelo CPM30 está equipado con un elemento neutro, un sistema de drenaje conectado a la red y un sistema táctil para eliminar los depósitos de almidón de la pasta -el mod. CP11N es para banco y posee un sistema de descarga con acople frontal tipo bayoneta y par de cestos pequeños.

RU Электрическая плита для приготовления макарон. Корпус и корзины из нержавеющей стали - чаша из нержавеющей стали толщиной 15/10 AISI 316 - ручки корзины из изоляционного материала - бронированные нагревательные элементы из нержавеющей стали инколой - кран подачи воды, подключаемый к сети - внешний клапан безопасности - поднятая дымоход с функцией защиты от брызг. Модель CPM30 оснащена нейтральным элементом, дренажной системой, подключенной к сети, и сенсорной системой для удаления отложений крахмала макарон. - мод. CP 11N в настольном исполнении и оснащена системой выпуска с фронтальным байонетным соединением и две малых корзины.

	CP11N	CPM30
	3,5 kW	8 kW
	-	400V/3N/50-60Hz
	230V/1N/50-60Hz	-
	20±100°C ~20'	20±100°C ~30'
	7 Kg/h	15 Kg/h
	10 L	30 L
	1 Kg	3 Kg
	330 x 600 x 380(h) mm	400 x 700 x 1040(h) mm
		
	16,5 Kg	49 Kg
	18 Kg	59 Kg
	710 x 390 x 410(h) mm	480 x 780 x 1200(h) mm
	0,113 m³	0,449 m³

CPM30M
CPM30DM



CPM30M



CPM30DM

Cuocipasta
a gas

GAS PASTA COOKERS
CUISEURS À PÂTE À GAZ
GAS NUDELKOCHER
COCEDORES DE PASTA DE GAS
ГАЗОВЫЕ МАКАРОНОВАРКИ

IT Struttura e cestelli in acciaio inox - vasche in acciaio inox AISI 316 spessore 15/10 trattate con speciale sabbiatura a microsferi in ceramica - sistema a sfioramento per eliminare i residui di deposito di amido della pasta - manici cestelli e pomelli coperchi in materiale isolante - pratico rubinetto carico acqua collegabile alla rete posto sul cruscotto - camino rialzato con funzione paraspruzzi - bruciatori in acciaio inox a alto rendimento, con combustione ottimizzata, posti sotto la vasca, dotati di valvola di sicurezza e termocoppia - accensione con piezoelettrico e fiamma pilota - regolazione di potenza indipendente per ogni vasca - alimentazione a metano, in dotazione kit GPL - dotato di falso fondo appoggio cestelli e mobile.

















EN Stainless steel casing and baskets - AISI 316 stainless steel bowls, thickness 15/10, sandblasted with special ceramic microspheres - touch system to remove pasta starch deposits - basket handles and knobs made of insulating material - handy water filling tap that can be connected to the main network on the front panel - raised chimney with backsplash function - high-performance stainless steel burners, with optimized combustion, placed under the bowl, equipped with safety valve and thermocouple - ignition with piezoelectric and pilot flame - independent power regulation for each bowl - natural gas ready, supplied with LPG kit - with false bottom for baskets support on a neutral element.

FR Corps et paniers en acier inoxydable - Cuves en acier inoxydable AISI 316, épaisseur 15/10, sablées avec microsphères spéciales en céramique - système tactile pour éliminer les dépôts d'amidon de pâtes - poignées et boutons en matériau isolant - robinet de remplissage d'eau pratique pouvant être connecté au réseau principal sur le panneau avant - cheminée haute avec fonction de dossier - brûleurs en inox haute performance, à combustion optimisée, placé sous la cuve, équipé d'une soupape de sécurité et d'un thermocouple - allumage avec flamme piézoélectrique et veilleuse - régulation indépendante de la puissance pour chaque cuve - prêt pour le gaz naturel, fourni avec kit GPL - avec faux fond pour le support des paniers sur un élément neutre.

DE Gehäuse und Körbe aus Edelstahl - Wannen aus Edelstahl AISI 316, Dicke 15/10, sandgestrahlt mit speziellen keramischen Mikrokugeln - Touch-System zum Entfernen von Nudelstärkeablagerungen - Korbgriffe und -knöpfe aus Isoliermaterial - praktischer Wasserfüllhahn, der an das Hauptnetz auf der Vorderseite angeschlossen werden kann - erhöhter Schornstein mit Aufkantungsfunktion - Hochleistungs-Edelstahlbrenner, mit optimierter Verbrennung, unter der Wanne angebracht, mit Sicherheitsventil und Thermoelement ausgestattet - Zündung mit piezoelektrischer und Pilotflamme - unabhängige Leistungsregelung für jede Wanne - erdgasbereit, geliefert mit LPG-Kit - mit Doppelboden für Korbablage auf einem neutralen Element.

ES Carcasa y cestas de acero inoxidable - cubas de acero inoxidable AISI 316, espesor 15/10, tratadas con chorro de arena con microesferas de cerámica especial - sistema táctil para eliminar los depósitos de almidón de la pasta - manijas de las cestas y pomos de material aislante - práctico grifo de llenado de agua que puede conectarse a la red principal a través del panel frontal - chimenea levantada con función de rebaba de salpicaduras - quemador de acero inoxidable de alto rendimiento, con combustión optimizada, colocado debajo de la cuba, equipado con válvula de seguridad y termopar - encendido con llama piezoeléctrica y piloto - regulación de potencia independiente para cada cuba - preparado para gas natural, suministrado con kit GLP - con falso fondo para el apoyo de las cestas sobre un elemento neutro.

RU Корпус и корзины из нержавеющей стали - Чашки из нержавеющей стали AISI 316, толщина 15/10, пескоструйная обработка специальными керамическими микросферами - сенсорная система для удаления отложений крахмала макарон - ручки и ручки из изоляционного материала - удобный кран для наполнения водой, который можно подключить к основной сети на лицевой панели - поднятая труба с функцией обратного рассеяния - высокоэффективные конфорки из нержавеющей стали, с оптимизированным сжиганием, помещенный под чашу, оснащенный предохранительным клапаном и термопарой - зажигание с пьезоэлектрическим и пилотным пламенем - независимое регулирование мощности для каждой чашки - готовый природный газ, поставляется с комплектом для подключения сжиженного газа - с двойным дном для поддержки корзин на нейтральном элементе.

	CPM30M	CPM30DM
	10 kW	10 kW + 10 kW
	8600 kcal/h - 34120 BTU/h	8600 + 8600 kcal/h 34120 + 34120 BTU/h
	G20 = 1,05 m³/h G25 = 1,23 m³/h	G20 = 1,05 + 1,05 m³/h G25 = 1,23 + 1,23 m³/h
	G30/G31 = 0,78 Kg/h	G30/G31 = 0,78 + 0,78 Kg/h
	N° 1 (Bruciatori - Burners - Горелки)	N° 2 (Bruciatori - Burners - Горелки)
	20+100°C ~25'	
	15 Kg/h	15 + 15Kg/h
	25 L	25 + 25 L
	2,5 Kg	2,5 + 2,5 Kg
	400 x 700 x 1040(h) mm	800 x 700 x 1040(h) mm
		
	49 Kg	76 Kg
	59 Kg	91 Kg
	480 x 780 x 1200(h) mm	880 x 800 x 1200(h) mm
	0,449 m³	0,844 m³

Optional

ACCESSORIES
ACCESSOIRES
ZUBEHÖR
ACCESORIOS
AKCECCYAPЫ

	standard 2 basket	ACCECP11N	ACCE11	ACCE12	ACCE13	ACCE16
	Cuocipasta elettrici/gas - Electric/gas pasta cookers - Cuiseurs à pâte électriques/gas Elektronudelkocher/ Gasnudelkocher - Cocedores de pasta eléctricos/gas Электрические/ Газовые макаронварки					
Mod.	CP11N		CPM30 - CPM30M - CPM30DM			
	standard 2 basket	optional 1 baskets	CE1/1	CE1/2	CE1/3	CE1/6

A	520 mm		420 mm	550 mm	410 mm	195 mm
B	325 mm		330 mm		290 mm	140 mm
C	190 mm		60 x 2 mm	220 mm	60 x 2 mm	60 mm
D	100 mm	210 mm	290 mm	140 mm	105 mm	
E	170 mm		205 mm			
F	225 mm		400 mm	380 mm	400 mm	
G	-					
H	200 mm		285 mm			
I	345 mm		340 mm			
L	-					
M	225 mm		310 mm			

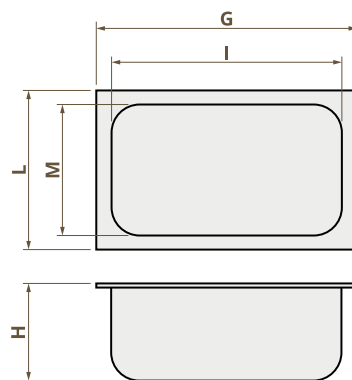
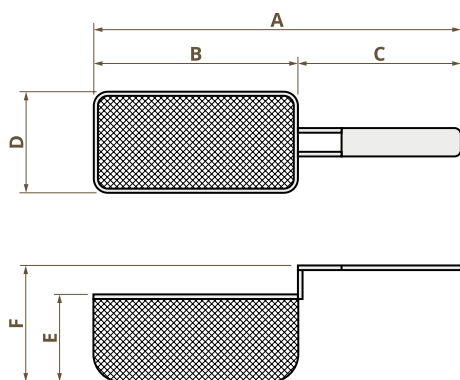

CE 1/1	CE 1/2	CE 1/2
CE 1/3	CE 1/2	CE 1/6
CE 1/3		CE 1/6
CE 1/3		CE 1/6

CE 1/3	CE 1/3		CE 1/6	CE 1/6
CE 1/3	CE 1/6	CE 1/6	CE 1/6	CE 1/6
CE 1/6	CE 1/6	CE 1/6	CE 1/6	CE 1/6

CP11N

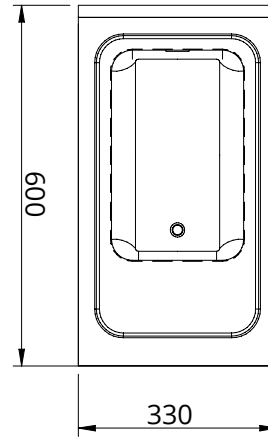
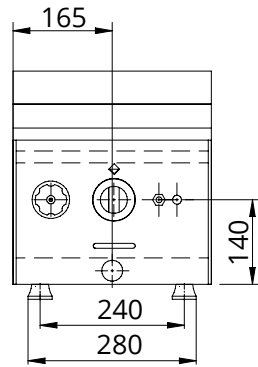

CPM30

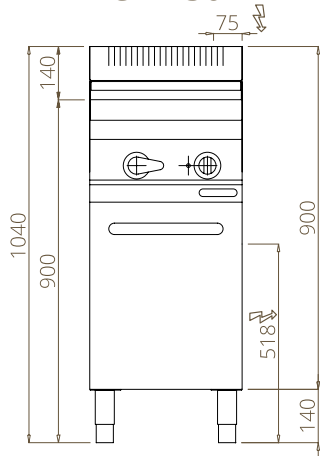

CPM30M

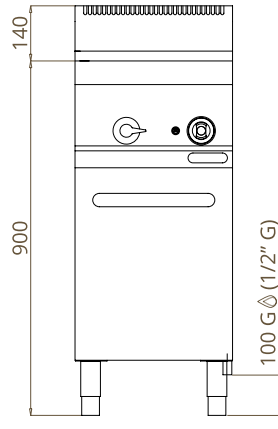

CPM30DM

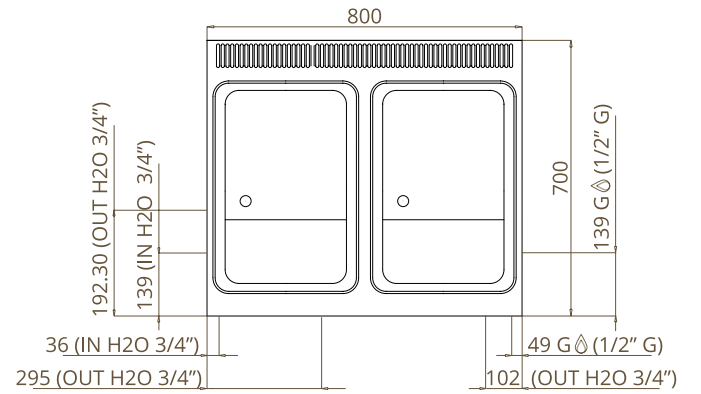
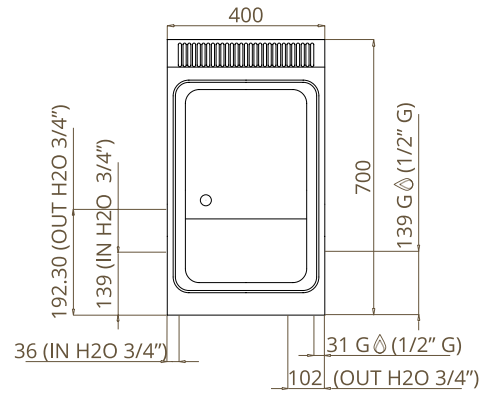
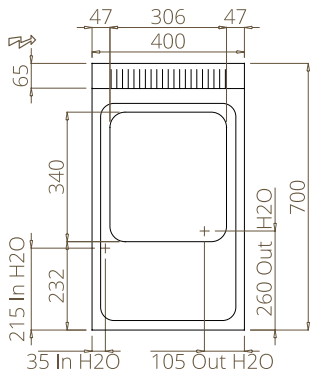
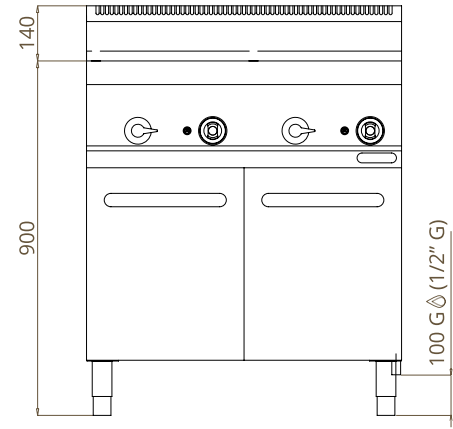

GL33
GL66



GL33



GL66

Griglie pietra lavica

modello GL

LAVA STONE GRILL
GRILLES À PIERRE LAVIQUE
LAVASTEINGRILL
PARRILLAS DE PIEDRA LÁVICA
ГРИЛЬ С ЛАВОВЫМ КАМНЕМ

IT Macchina da banco per cuocere carne, pesce, verdure, ecc.
Il funzionamento consiste nel riscaldare la pietra lavica posta su una griglia di supporto in acciaio. Struttura in acciaio inox - griglia di cottura in lamiera piegate a V in acciaio inox - accensione con piezoelettrico - alimentazione metano, in dotazione kit GPL - allacciamento gas 1/2"G - cassetto raccolta residui di cottura.

EN Tabletop appliance to cook meat, fish, vegetables, etc. The purpose is to heat the lava stone placed on a steel support grid. Stainless steel casing - stainless steel V-folded cooking grid - piezoelectric ignition - natural gas ready, supplied with LPG kit - 1/2"G gas connection - drawer for collecting cooking waste.

FR Machine de table pour la cuisson de viande, poisson, légumes, etc. Le fonctionnement consiste à chauffer la pierre de lave placée sur une grille de support en acier. Corps en acier Inox - grille de cuisson en acier inoxydable pliée à V - allumage piézoélectrique - alimentation en gaz naturel, fournie avec kit GPL - raccord gaz 1/2"G - tiroir de récolte des résidus de cuisson.

DE Aufstellgerät zum Kochen von Fleisch, Fisch, Gemüse, etc. Der Vorgang besteht in der Erwärmung des Lavasteins, der auf einem Stahlstützgitter liegt. Edelstahlgehäuse - Edelstahl V-förmig gefaltetes Gargitter - piezoelektrische Zündung - Erdgasversorgung, geliefert mit LPG-Kit - 1/2"G Gasanschluss - Kochreste Sammelfach.

ES Máquina sobre-mesa para cocinar carne, pescado, verduras, etc. La operación consiste en calentar la piedra de lava colocada sobre una rejilla de acero. Estructura de acero inoxidable - rejilla de cocción en V de acero inoxidable - encendido piezoeléctrico - alimentada con gas natural, suministrada con kit GLP - conexión de gas 1/2"G - cajón para la recogida de los residuos de cocción.

RU Настольная машина для приготовления мяса, рыбы, овощей и т.д. Операция заключается в нагревании лавового камня, помещенного на стальную опорную решетку. Конструкция из нержавеющей стали - V-образная складная решетка из нержавеющей стали - пьезоэлектрическое зажигание - комплект для подключения природного газа, для подключения сжиженного газа 1/2"G - выдвижной ящик для сбора остатков пищи.



GRIGLIA PESCE - FISH GRID

LAVAB50

Confezione lava - Pack of lava stone - Paquet de pierre de lave
Lavasteinpackung - Paquete de lava - Упаковка лавы 5 Kg

	GL33	GL66
	6,5 kW	13 kW
kcal/h BTU/h	5589 kcal/h 22179 BTU/h	11178 kcal/h 44358 BTU/h
METANO METHANE МЕТАНА	G20 = 0,71 m³/h G25 = 0,79 m³/h	G20 = 1,42 m³/h G25 = 1,59 m³/h
GPL LPG	G30/G31 = 0,49 Kg/h	G30/G31 = 0,98 Kg/h
	N° 1 (Bruciatori - Burners - горелки)	N° 2 (Bruciatori - Burners - горелки)
	N° 1 (Piezoelettrico - Piezoelectric Пьезоэлектрический)	N° 2 (Piezoelettrico - Piezoelectric Пьезоэлектрический)
	312 x 483 mm	312 x 483 mm x 2
	330 x 625 x 300(h) mm	660 x 625 x 300(h) mm
	24 Kg	49 Kg
	30 Kg	55 Kg
	395 x 670 x 370(h) mm	725 x 670 x 426(h) mm
	0,097 m³	0,206 m³

ACGRIFISH

Griglia per pesce - Fish grid
Grille pour poisson - Fischgrill
Parrilla para pescado - Решетка для рыбы



312 x 483 mm

B50-B80-B115









B50



B80

	MOVPCB50	MOVPCB80	MOVPCB115
	Mobile con portina e chiusura posteriore - Cabinet with door and rear closure - Meuble avec porte et fermeture arrière - Möbel mit Tür und Verschluss hinten - Mueble con puerta y cierre posterior - Шкаф с дверцей и задним закрытием		

	MOVAB50	MOVAB80	MOVAB115
	Mobile aperto - Mobile - Meuble ouvert - Offenües Möbel - Mueble abierto - Открытый шкаф		

	490 x 630 x 530(h) mm	810 x 630 x 530(h) mm	1140 x 630 x 530(h) mm
	16 Kg	21 Kg	27 Kg
	18 Kg	23 Kg	31 Kg
	720 x 510 x 150(h) mm	820 x 680 x 150(h) mm	1150 x 680 x 150(h) mm
	0,057 m ³	0,093 m ³	0,129 m ³



B115 + MOVPCB115 - CON MOBILE WITH HOUSING UNIT / ШКАФ С ДВЕРЦЕЙ И ЗАДНИМ ЗАКРЫТИЕМ

Griglie pietra lavica modello B

LAVA STONE GRILL
GRILLES À PIERE LAVIQUE
LAVASTEINGRILL
PARRILLAS DE PIEDRA LÁVICA
ГРИЛЬ С ЛАВОВЫМ КАМНЕМ

IT Macchina per cuocere carne, pesce, verdure, etc mediante il riscaldamento della pietra lavica su una griglia di supporto in acciaio. Struttura in acciaio inox - doppia parete di isolamento - griglia di cottura in ghisa smaltata opaca che può essere utilizzata da una parte per la carne e dall'altra per il pesce - griglia inclinabile in 4 posizioni - accensione con piezoelettrico - alimentazione a metano, in dotazione kit GPL - allacciamento da 1/2"G - cassetto raccolta residui di cottura. B80-B115 sono con regolazione e accensione indipendente di metà piano di cottura.















EN Appliance to cook meat, fish, vegetables, etc. by heating lava stone on a steel support grid. Stainless steel casing - double -layer insulation - matt enamelled cast iron grid that can be used for meat on one side and fish on the other - 4-position tilting grids - piezoelectric ignition - natural gas connection, LPG kit included - 1/2"G connection - cooking residue collection compartment. B80-B115 are equipped with independent adjustment and ignition of half of the cooking surface.

FR Appareil permettant de cuire de la viande, du poisson, des légumes, etc. en chauffant de la pierre de lave sur une grille de support en acier. Corps en acier inox - double paroi isolante - grille en fonte émaillée mate pouvant être utilisée d'un côté pour la viande et de l'autre pour le poisson - grille pivotante 4 positions - allumage piézoélectrique - raccordement au gaz naturel, kit GPL fourni - raccordement 1/2"G - tiroir de recueil des restes de cuisson. B80-B115 sont équipés d'un réglage et d'un allumage indépendants de la moitié de la surface de cuisson.

DE Gerät zum Kochen von Fleisch, Fisch, Gemüse usw. durch Erhitzen von Lavastein auf einem Stahlstützgitter. Gehäuse aus Edelstahl - doppelte Isolierwand - matt emaillierter Gusseisengitter, der auf der einen Seite für Fleisch und auf der anderen Seite für Fisch verwendet werden kann - 4 Positionen schwenkbare Gitter - piezoelektrische Zündung - Erdgasanschluss, LPG-Kit im Lieferumfang enthalten - 1/2"G-Anschluss - Kochreste Sammelfach. B80-B115 sind mit unabhängiger Einstellung und Zündung der Hälfte der Kochfläche ausgestattet.

ES Máquina para cocinar carne, pescado, verduras, etc. calentando piedra de lava sobre una rejilla de soporte de acero. Cuerpo de acero inoxidable - doble pared aislante - rejilla de cocción de hierro fundido esmaltado mate que puede utilizarse en un lado para carne y en el otro para pescado - parrilla inclinable en 4 posiciones - encendido piezoeléctrico - alimentación de gas natural, kit GLP incluido - conexión 1/2"G - cajón de recogida de residuos de cocción. B80-B115 permiten el ajuste y el encendido independiente de la mitad de la superficie de cocción.

RU Прибор для приготовления мяса, рыбы, овощей и т.д. путем нагрева лавового камня на стальной опорной решетке. Корпус из нержавеющей стали - двойная изоляционная стенка - матовая эмалированная чугунная решетка, которую можно использовать для мяса с одной стороны и рыбы с другой - 4-позиционные поворотные решетки - пьезоэлектрический электроподжиг - подключение природного газа, комплект для сжиженного газа входит в комплект - подключение 1/2"G - отсек для сбора остатков пищи. B80-B115 оснащены независимой регулировкой и розжигом половины варочной поверхности.

	B50	B80	B115
	8,5 kW	17 kW	23 kW
	7.309 kcal/h 29.002 BTU/h	14.617 kcal/h 58.004 BTU/h	19.776 kcal/h 78.476 BTU/h
	G20 = 0,90 m³/h G25 = 1,05 m³/h	G20 = 1,80 m³/h G25 = 2,09 m³/h	G20 = 2,43 m³/h G25 = 2,83 m³/h
	G30/G31 = 0,67 Kg/h	G30/G31 = 1,34 Kg/h	G30/G31 = 1,81 Kg/h
	N° 3 (Bruciatori - Burners горелки)	N° 6 (Bruciatori - Burners горелки)	N° 8 (Bruciatori - Burners горелки)
	N° 1 (Piezoelettrico - Piezoelectric Пьезоэлектрический)	N° 2 (Piezoelettrico - Piezoelectric - Пьезоэлектрический)	
	320 x 540 mm	640 x 540 mm	960 x 540 mm
	490 x 700 x 380(h) mm	810 x 700 x 380(h) mm	1140 x 700 x 380(h) mm
			
	44 Kg	76 Kg	108 Kg
	50 Kg	83 Kg	115 Kg
	720x 540 x 420(h) mm	850 x 740 x 420(h) mm	1180 x 740 x 420(h) mm
	0,163 m³	0,264 m³	0,036 m³

LAVAB50

Confezione lava - Pack of lava stone - Paquet de pierre de lave
Lavasteinpackung - Paquete de lava - Упаковка лавы 5 Kg

FRY1L-FRY1LC
FRY1R-FRY1RC
FRY2L-FRY2LC-FRY2LR
FRY2LRC-FRY2VCE



FRY1L



FRY1R



FRY2LC

Fry Top
elettrici

ELECTRIC FRY-TOPS
FRY-TOP ÉLECTRIQUE
ELEKTRISCHE FRY TOP
FRY TOP ELÉCTRICOS
ЭЛЕКТРИЧЕСКИЕ ЖАРОЧНЫЕ ПОВЕРХНОСТИ

IT Macchina elettrica per cottura a secco o ad olio. Struttura in acciaio inox - piano di cottura in acciaio sabbiato o cromato liscio, rigato o misto oppure in vetroceramica (solo mod. FRY2VCE) - termostati di regolazione temperatura 50÷300°C - cassetto raccolta residui di cottura - i modelli doppi permettono la regolazione e l'accensione indipendente di metà piano di cottura. Spatola inclusa.

FR Machine électrique pour la cuisson à sec ou à l'huile. Structure en acier inox - plan de cuisson en acier sablé ou chromé lisse, nervuré ou mixte ou à vitroceramique (soulement mod. FRY2VCE) - thermostats de réglage de la température de 50 à 300°C - tiroir de récolte de résidus de cuisson. Les modèles doubles permettent le réglage et l'allumage indépendants des deux moitiés de la surface de cuisson. Spatule incluse.

ES Máquina eléctrica para la cocción en seco o con aceite. Estructura de acero inoxidable - plano de cocción de acero enarenado o cromado liso, rayado o mixto o vitrocerámica (sólo mod. FRY2VCE) - termostatos de regulación de la temperatura 50÷300°C - cajón recolección residuos de cocción. Los modelos dobles permiten el ajuste y la ignición independientes de las dos mitades de la superficie de cocción. Espátula incluida.

EN Electric operated machine for dry or oil cooking. Stainless steel casing - smooth, grooved or mixed sanded or chromed steel cooking surface or ceramic glass (mod. FRY2VCE only) - 50÷300°C temperature adjustment thermostats - drip drawer - dual models allow independent adjustment and ignition of the two cooking surface halves. Spatula included.

DE Elektrogerät zum Trocken- oder Ölgaren. Gehäuse aus Edelstahl - Kochplatte aus sandgestrahltem oder verchromtem Stahl, glatt, gerillt, kombiniert oder Glaskeramik (nur Mod. FRY2VCE) - Thermostat zur Einstellung der Temperatur von 50 bis 300°C - Kochreste-Sammelkasten. Doppelmodelle ermöglichen die unabhängige Einstellung und Zündung der beiden Kochflächenhälften. Spachtel inbegriffen.









RU Электрический прибор для приготовления пищи на масле или без масла. Корпус из нержавеющей стали, гладкая, рифленая или комбинированная жарочная поверхность из нержавеющей стали, подвергнутой пескоструйной обработке или хромированный. Стекло - керамика (только для мод. FRY2VCE), термостаты для регулировки температуры 50÷300°C, поддон для сбора отходов. В двойных моделях существует возможность независимой регулировки и включения половины жарочной поверхности. Шпатель в комплекте.



FRY1RC



FRY2LR

	FRY1L	FRY1LC	FRY1R	FRY1RC	FRY2L	FRY2LC	FRY2LR	FRY2LRC	FRY2VCE
	3 kW				6 kW				3,6 kW
	-				400V/3N/50-60Hz				-
	230V/1N/50-60Hz				-				230V/1N/50-60Hz
	50÷300°C				50÷300°C				
	Liscia - Smooth - Гладкий	Rigata - Grooved - Рифлёный		Liscia - Smooth Гладкий		Mista - Mixed комбинированная		Liscia in vetroceramica Smooth glass ceramic Стекло - керамика Гладкий	
	325 x 480 mm				650 x 480 mm				600 x 400 mm
	335 x 570 x 300(h) mm				665 x 570 x 300(h) mm				680 x 530 x 110(h) mm
									
	22 Kg				40 Kg				13 Kg
	30 Kg				53 Kg				22 Kg
	670 x 410 x 430(h) mm				750 x 670 x 430(h) mm				740 x 600 x 330(h) mm
	0,118 m³				0,216 m³				0,146 m³



FRY2VCE

Fry Top gas

FRY1LM-FRY1LMC
FRY1RM-FRY1RMC
FRY2LM-FRY2LMC
FRY2LRM-FRY2LRMC



FRY1RM



FRY1LMC



FRY2LRM

GAS FRY TOP
FRY TOP A GAZ
GAS FRY TOP
FRY TOP A GAS
ГАЗОВЫЕ ЖАРОЧНЫЕ ПОВЕРХНОСТИ

IT Macchina a gas per cottura a secco o ad olio. Struttura in acciaio inox - piano di cottura in acciaio sabbiato o cromato liscio, rigato o misto - alimentazione a gas metano, in dotazione kit G.P.L - allacciamento gas 1/2"G - manopole di regolazione potenza fiamma - cassetto raccolta residui di cottura - accensione con piezoelettrico. I modelli doppi permettono la regolazione e l'accensione indipendente di metà piano di cottura. Spatola inclusa.

FR Machine à gaz pour la cuisson à sec ou à l'huile. Corps en acier Inox - plan de cuisson lisse, nervuré ou mixte en acier sablé ou chromé - prêt pour le gaz naturel, livré avec kit GPL - raccord gaz 1/2"G - boutons de réglage de puissance de flamme - tiroir pour le recueil des restes de cuisson - allume piézoélectrique. Les modèles doubles permettent le réglage et l'allumage indépendants des deux moitiés de la surface de cuisson. Spatule incluse.

ES Máquina a gas para la cocción en seco o con aceite. Estructura de acero inoxidable - plano de cocción de acero enarenado o cromado liso, rayado o mixto - alimentación a gas metano, en dotación kit G.P.L - conexión de gas 1/2"G - pomos de regulación potencia de la llama - cajón recolección residuos de cocción- encendido con piezoeléctricos. Los modelos dobles permiten el ajuste y la ignición independientes de las dos mitades de la superficie de cocción. Espátula incluida.

EN Gas-operated machine for dry or oil cooking. Stainless steel casing - smooth, grooved or mixed sanded or chromed steel cooking surface - natural gas ready, supplied with LPG kit - 1/2"G gas connection - flame power adjustment knobs - cooking waste collection drawer - piezoelectric ignition. Dual models allow independent adjustment and ignition of the two cooking surface halves. Spatula included.

DE Gasgerät zum Trocken- oder Ölgaren. Gehäuse aus Edelstahl - Kochplatte aus sandgestrahltem oder verchromtem Stahl, glatt, gerillt oder kombiniert - Erdgasversorgung, LPG-Kit im Lieferumfang - 1/2"G Gasanschluss - Drehknöpfe zur Einstellung der Flammenstärke - Kochreste-Sammelkasten - Einschaltung mit Piezoelektrik. Doppelmodelle ermöglichen die unabhängige Einstellung und Zündung der beiden Kochflächenhälften. Spachtel inbegriffen.











RU Газовый прибор для приготовления пищи на масле или без масла. Корпус из нержавеющей стали, гладкая, рифленая или комбинированная жарочная поверхность из нержавеющей стали, подвергнутой пескоструйной обработке или хромированный, работа на сжиженном природном газе, в комплекте с оснасткой для работы на метане, ручки для регулировки мощности пламени, поддон для сбора отходов, пьезоэлектрическое зажигание. В двойных моделях существует возможность независимой регулировки и включения половины жарочной поверхности. Шпателя в комплекте.



FRY1LM



FRY2LM

	FRY1LM	FRY1LMC	FRY1RM	FRY1RMC	FRY2LM	FRY2LMC	FRY2LRM	FRY2LRMC
	4 kW				8 kW			
kcal/h BTU/h	3.308 kcal/h 13.235 BTU/h				3.308 + 3.308 kcal/h 13.235 + 13.235 BTU/h			
METANO METHANE МЕТАНА	G20 = 0,41 m³/h G25 = 0,51 m³/h				G20 = 0,41 + 0,41 m³/h G25 = 0,51 + 0,51 m³/h			
GPL LPG	G30/G31 = 0,31 Kg/h				G30/G31 = 0,31 + 0,31 Kg/h			
	N° 1 (Bruciatori - Burners - горелки)				N° 2 (Bruciatori - Burners - горелки)			
	N° 1 (Piezoelettrico - Piezoelectric - Пьезоэлектрический)				N° 2 (Piezoelettrico - Piezoelectric - Пьезоэлектрический)			
	Liscia - Smooth - Гладкий		Rigata - Grooved - Рифлёный		Liscia - Smooth - Гладкий		Mista - Mixed - комбинированная	
	325 x 480 mm				650 x 480 mm			
	355 x 600 x 300(h) mm				665 x 600 x 300(h) mm			
								
	24 Kg				42 Kg			
	31 Kg				55 Kg			
	410 x 670 x 430(h) mm				750 x 670 x 430(h) mm			
	0,118 m³				0,216 m³			

GYR40-GYR60 GYR80-GYR100



GYR80



GYR100

Gyros
elettrici

ELECTRIC GYROS
GYROS ÉLECTRIQUES
ELEKTRISCHER GYROS
GYROS ELÉTRICOS
ЭЛЕКТРИЧЕСКИЕ ВЕРТИКАЛЬНЫЕ
ШАШЛЫЧНИЦЫ

IT Macchina per cuocere carne per Kebab. Struttura, asta spiedo e paletta raccogli carne in acciaio inox - resistenze ad infrarossi rivestite in ceramica (4 per il modello GYR40 - 6 per il modello GYR60 - 8 per il modello GYR80 - 10 per il modello GYR100), con vetro di protezione resistente alle alte temperature che ne facilita la pulizia e abbassa i consumi - regolazione resistenze a settori - regolazione distanza asta spiedo dalle resistenze - cassetto di raccolta residui di cottura in acciaio inox - diametro max. carne consentito 470 mm - 3 livelli di potenza.

FR Cuisinière à kebab. Corps, barre de grill et pelle à viande en acier Inox - éléments chauffants infrarouges à revêtement céramique (4 pour le modèle GYR40 - 6 pour le modèle GYR60 - 8 pour le modèle GYR80 - 10 pour le modèle GYR100), avec verre de sécurité haute température qui facilite le nettoyage et réduit la consommation - réglage des éléments chauffants par secteur - réglage de la distance de la barre du grill des éléments chauffants - tiroir pour le recueil des restes de cuisson - diamètre maximum pour la viande 470 mm - 3 puissances.

ES Estufa de Kebab. Cuerpo, barra de asar y pala para carne de acero inoxidable - elementos calefactores infrarrojos recubiertos de cerámica (4 para el modelo GYR40 - 6 para el modelo GYR60 - 8 para el modelo GYR80 - 10 para el modelo GYR100), con vidrio de seguridad de alta temperatura para una fácil limpieza y un consumo reducido - regulación sectorial de los elementos calefactores - regulación de la distancia de la barra de asar de la parrilla con respecto a los elementos calefactores - cajón para la recogida de los residuos de la cocción - diámetro máximo de la carne de 470 mm - 3 potencias.

EN Kebab cooker. Stainless steel casing, skewer and meat collection fork - ceramic coated infrared heating elements (4 for the GYR40 model - 6 for the GYR60 model - 8 for the GYR80 model - 10 for the GYR100 model), with high temperature resistant safety glass that facilitates cleaning and lowers consumption - sector heating elements adjustment - skewer distance adjustment from heating elements - drip tray - max. meat diameter allowed 470 mm - 3 power levels.

DE Kebabherd. Gehäuse, Grillstab und Fleischschaufel aus Edelstahl - keramikbeschichtete Infrarot-Heizelemente (4 für Modell GYR40 - 6 für Modell GYR60 - 8 für Modell GYR80 - 10 für Modell GYR100), mit Hochtemperatur-Sicherheitsglas für eine einfache Reinigung und reduzierten Verbrauch - sektorspezifische Einstellung der Heizelemente - Einstellung des Abstandes der Grillstange zu den Heizelementen - Kochreste-Sammelkasten - maximaler Durchmesser für Fleisch 470 mm - 3 Leistungsstufen.













RU Кебабовая плита. Корпус из нержавеющей стали, шпалка и вилка для сбора мяса - инфракрасные нагревательные элементы с керамическим покрытием (4 для модели GYR40 - 6 для модели GYR60 - 8 для модели GYR80 - 10 для модели GYR100), с термостойким безопасным стеклом, что облегчает очистку и снижает расход - регулировка нагревательных элементов сектора - регулировка расстояния между шамперами и нагревательными элементами - каплесборник - максимальный диаметр 470 мм - 3 уровня мощности.



GYR40



GYR60

	GYR40	GYR60	GYR80	GYR100
	2,8 kW	4,2 kW	5,6 kW	7 kW
	-	230-400V/3-3N/50Hz		
	230V/1N/50Hz	-		
	280÷320 mm	410÷460 mm	590÷640 mm	710÷760 mm
	5÷10 Kg - ø 470 mm	10÷30 Kg - ø 470 mm	30÷65 Kg - ø 470 mm	50÷85 Kg - ø 470 mm
	N° 4	N° 6	N° 8	N° 10
	510 x 530 x 750÷1220*(h) mm	510 x 530 x 870÷1340*(h) mm	510 x 530 x 1060÷1530*(h) mm	510 x 530 x 1220÷1690*(h) mm
				
	21 Kg	25 Kg	28 Kg	33 Kg
	32 Kg	36 Kg	39 Kg	44 Kg
	620 x 680 x 1030(h) mm*		620 x 680 x 1250(h) mm*	
	0,44 m³		0,53 m³	

Special Voltages - Разное питающее напряжение

* + 500 mm

Dimensione di macchina con cappa con filtro.

Packing size with filtered hood.

Emballage avec hotte avec filtre.

Verpackungsgröße mit Filterhaube.

Embalaje con campana de filtro opcional.

Размер упаковки с дополнительным кожухом фильтра.

Gyros a gas

GYR60M
GYR80M
GYR80MD



GYR60M



GYR80M

















GYR80MD

GAS GYROS
GYROS A' GAZ
GAS GYROS
GYROS DE GAS
ГАЗОВЫЕ ВЕРТИКАЛЬНЫЕ ШАШЛЫЧНИЦЫ

OPTIONAL





- IT** Macchina per cuocere carne per Kebab. Struttura, asta, spiedo e paletta raccogli carne in acciaio inox - bruciatori ad infrarossi con piastra in ceramica - rete protezione bruciatori asportabile - regolazione bruciatori a settori - accensione con piezoelettrico - alimentazione a metano, in dotazione kit GPL - regolazione distanza asta spiedo dalle resistenze - cassetto di raccolta residui di cottura in acciaio inox. Allacciamento gas 1/2"G.
- EN** Kebab cooker - stainless steel casing, skewer and meat collection fork - infrared burners with ceramic plate - removable burner protection net - burner regulation by sectors - ignition with piezoelectric - natural gas ready, supplied with LPG kit - skewer distance adjustment from heating elements - stainless drip tray. 1/2"G gas connection.
- FR** Cuisinière à kebab - corps, barre de grill et pelle à viande en acier Inox - brûleurs infrarouges avec plaque céramique - protection de brûleur amovible - régulation des brûleurs à secteur - allumage piézo-électrique - alimentation gaz naturel, kit GPL inclus - réglage de la distance de la barre du grill des éléments chauffants - tiroir pour le recueil des restes de cuisson. Raccord gaz 1/2"G.
- DE** Kebabherd - Gehäuse, Grillstab und Fleischschaufel aus Edelstahl- Infrarotbrenner mit Keramikplatte - abnehmbares Brennerschutznetz - Sektorbrennerregelung - piezoelektrische Zündung - Erdgasversorgung, LPG-Kit mitgeliefert - Einstellung des Abstandes der Grillstange zu den Heizelementen - Kochreste-Sammelkasten. Gasanschluss 1/2"G.
- ES** Estufa de Kebab - cuerpo, barra de asar y pala para carne de acero inoxidable - quemadores infrarrojos con placa cerámica - red desmontable de protección de los quemadores - regulación de los quemadores del sector - encendido piezoeléctrico - suministro de gas natural, kit GLP incluido - regulación de la distancia de la barra de asar de la parrilla con respecto a los elementos calefactores - cajón para la recogida de los residuos de la cocción. Conexión de gas 1/2"G.
- RU** Кабинная печь - корпус из нержавеющей стали, барбекю-бар и лопатка - инфракрасные горелки с керамической плитой - съемная защитная сетка горелки - регулирование секторных горелок - пьезоэлектрическое зажигание - подача природного газа, в комплект поставки входит набор LPG - регулирование расстояния гриль-барбекю от нагревательных элементов - ящик для сбора отходов приготовления. Подключение газа 1/2 "G.



	GYR60M	GYR80M	GYR80MD
	10,2 kW	13,6 kW	13,6 + 13,6 kW
	8772 kcal/h 34810 BTU/h	11696 kcal/h 46413 BTU/h	11696 + 11696 kcal/h 46413 + 46413 BTU/h
	G20 = 1,05 m³/h G25 = 1,23 m³/h	G20 = 1,27 m³/h G25 = 1,48 m³/h	G20 = 1,27 + 1,27 m³/h G25 = 1,48 + 1,48 m³/h
	G30/G31 = 0,71 Kg/h	G30/G31 = 0,95 Kg/h	G30/G31 = 0,95 + 0,95 Kg/h
	N° 6 (Bruciatori - Burners горелки)	N° 8 (Bruciatori - Burners горелки)	N° 8 + 8 (Bruciatori - Burners горелки)
	470÷520 mm	630÷680 mm	620÷670 mm
	10÷30 Kg ø 500 mm	30÷65 Kg ø 500 mm	50÷80 Kg ø 580 mm
	480 x 500 x 940÷1210*(h) mm	480 x 500 x 1105÷1375*(h) mm	570 x 620 x 1120÷1590*(h) mm
			
	27 Kg	33 Kg	48 Kg
	38 Kg	44 Kg	59 Kg
	620 x 680 x 1030(h) mm*	620 x 680 x 1250(h) mm*	
	0,44 m³	0,53 m³	

* + 500 mm
 Dimensione di macchina e imballo con cappa con filtro.
 Packing size with filtered hood.
 Emballage avec hotte avec filtre.
 Verpackungsgröße mit Filterhaube.
 Embalaje con campana de filtro opcional.
 Размер упаковки с дополнительным кожухом фильтра.

Optional

ACCESSORIES
ACCESSOIRES
ZUBEHÖR
ACCESORIOS
AKCECCYAPЫ

	ACCOLGYR80D	ACCOLGYR80HM	ACCOLGYR100
Model	Coltello elettrico professionale con trasformatore - Professional electric knife with transformer Couteau électrique professionnel avec transformateur - Professionelles elektrisches Messer mit Stromwandler Cuchilla eléctrica profesional con transformador - Электрический профессиональный нож с трансформатором		Coltello elettrico - Electric knife Couteau électrique - Elektrisches Messer Cuchilla eléctrica - Электрический нож MADE IN CHINA
		Regolazione automatica potenza motore Automatic engine control Régulation automatique de la puissance du moteur Automatische Motorleistungseinstellung Regulación automática de la potencia del motor автоматической регулировкой мощности двигателя	
	ø 80 mm		ø 100 mm
			

	ACKVGYR40	ACKVGYR60	ACKVGYR80	ACKVGYR100	ACCAGYR
Model	Kit vetri di protezione - Safety glass set - Kit verre de protection Schutzglas-Set - Kit de cristales de protección Набор защитных стёкол				Cappa con filtro a carboni attivi - Hood with active carbon filter Capot avec filtre à charbon actif - Haube mit Aktivkohlefilter Campana con filtro de carbón activo Вытяжка с фильтром из активированного угля
Mod.	GYR40	GYR60	GYR80	GYR100	SOLO PER MODELLI ELETTRICI - ONLY FOR ELECTRIC MODELS
					

RS40-RS70
SAL600MB



RS40



RS70













Salamandre

SALAMANDERS
SALAMANDER
SALAMANDER
SALAMANDRAS
ГРИЛЬ САЛАМАНДР

- IT** Macchina per scaldare, gratinare e tostare. Struttura in acciaio inox - griglia cromata e cassetto raccolta residui di cottura removibili - termostati con 3 regolazioni di potenza - regolazione posizione griglia. Il modello SAL600MB ha la testa mobile.
- EN** Heating, grating and toasting appliance. Stainless steel casing - chrome-plated grill and removable cooking waste collection drawer - thermostats with 3 power settings - grill position settings. The model SAL600MB has a tilting top.
- FR** Machine pour chauffer, gratiner et griller des aliments. Structure en acier Inox - grille chromée et tiroir de récupération des résidus de cuisson amovible - thermostats avec 3 réglages de puissance - réglage de la position de la grille. Le modèle SAL600MB a une tête pivotante.
- DE** Maschine zum Erwärmen, Gratieren und Toasten von Speisen. Edelstahl-gahäuse - verchromter Grill und herausnehmbare Kochrückständen Sam-melfach - Thermostate mit 3 Leistungsstufen - Grillpositionseinstellungen. Das Modell SAL600MB hat einen beweglichen Kopf.
- ES** Estructura de acero inoxidable - parrilla cromada y cajón recolección residuos de cocción extraíble - termostato regulación potencia - regulación posición parrilla. El modelo SAL600MB posee el cabezal móvil.
- RU** Корпус из нержавеющей стали, съемные хромированная решетка и поддон для сбора отходов, термостаты для регулирования мощности, регулировка положения решетки. Модель SAL600MB имеет подвижный верхний нагревательный блок.



SAL600MB

	RS40	RS70	SAL600MB
	2,2 kW	3,2 kW	4,7 kW
	-		400V/3N/50-60Hz
	230V/1N/50-60Hz		-
	70±210 mm		110±270 mm
	400 x 290 mm	670 x 290 mm	530 x 325 mm
	600 x 370 x 400(h) mm	880 x 370 x 400(h) mm	600 x 560 x 620(h) mm
			
	15 Kg	21 Kg	47 Kg
	17 Kg	23 Kg	59 Kg
	650 x 450 x 460(h) mm	930 x 470 x 470(h) mm	670 x 630 x 880(h) mm
	0,138 m³	0,205 m³	0,371 m³



Snack Bar

SNACK BAR
ЗАКУСОЧНАЯ

IT

Macchinari di alta qualità italiana per preparare freschi e gustosi cocktail, frappè, spremute ma anche gustosi panini, toast, crepé o hotdog. Machine per Frappè, Frullatori, Spremiagrumi, Tritaghiaccio, Gruppi Multipli, Piastre Elettriche, Crepiere, Toastiere, Hot Dog e Pressagelato.

FR

Machines de qualité italienne pour préparer des cocktails, milkshakes, jus de fruits frais et savoureux, mais aussi des sandwiches, toasts, crêpes ou hot-dogs succulents. Machines pour Frappé, Mélangeurs, Centrifugeuses, Concasseurs à glace, Groupes Multiples, Plaques électriques, Crêpières, Grille-pain, Hot-dogs et Presse à glace.

ES

Máquinas de calidad italiana para preparar cocteles frescos y sabrosos, batidos, zumos y también bocadillos, tostadas, crepes o perritos calientes. Batidoras para granizados o batidos, licuadoras, exprimidores, picadoras de hielo, grupo múltiples, placas eléctricas, máquina para crepes, tostadoras, máquina para perritos calientes y prensadores para helado.

EN

Italian quality machinery to prepare fresh and tasty cocktails, milkshakes, juices but also delicious sandwiches, toasts, crêpes or hotdogs. Milkshake Machines, Blenders, Juicers, Ice Crushers, Multiple Groups, Electric Plates, Crêpes Machines, Toasters, Hot Dogs and Ice Cream Presses.

DE

Maschinen von italienischer Qualität zur Zubereitung von frischen und leckeren Cocktails, Milchshakes, Säften, aber auch von köstlichen Sandwiches, Toasts, Crepes oder Hotdogs. Maschinen für Frappé, Mixer, Entsafter, Eisbrecher, Multizweckanlagen, Elektroplatten, Crêpes-Maschinen, Toaster, Hot Dogs und Eis-Pressen.

RU

Машины итальянского качества для приготовления свежих и вкусных коктейлей, молочных коктейлей, соков, а также вкусных сэндвичей, тостов, блинов или хот-догов. Машины для фраппе, блендеров, соковыжималок, ледяных дробилок, нескольких групп, электроплит, блинов, тостеров, хот-догов и прессов.

FR150I-FR150P
FR200P-FR2150I
FR2150P



FR150I



FR150P

Frullatori

BLENDERS
MIXEURS
MIXER
BATIDORAS
БЛЕНДЕРЫ

IT Macchina per preparare frullati, frappè ecc. Struttura in lega di alluminio verniciato - microinterruttore su coperchio - coltello removibile a quattro lame in acciaio inox - tappo su coperchio per aggiungere ingredienti in fase di lavoro - disponibile con bicchiere in lexan o acciaio inox. I modelli doppi sono dotati di un gruppo coltello ed un gruppo mescolatore. Il modello FR200P è dotato di variatore di velocità
Optional: Bicchiere inox o lexan per frullati o per frappè.

FR Machine pour préparer les jus à base de fruits, les frappé, etc. Corps en alliage d'aluminium peint - micro-contact sur le couvercle - couteau amovible à quatre lames en acier inox - bouchon sur le couvercle pour ajouter des ingrédients durant le travail - disponible avec un verre en lexan ou en acier inox. Les modèles doubles sont munis d'un groupe de couteaux et d'un groupe mélangeur.
Le modèle FR200P a le variateur de vitesse.
Extras: Verre en inox ou lexan pour les jus ou les frappés.

ES Máquina para preparar batidos, granizados, etc. Estructura de aleación de aluminio pintado - microinterruptor en la tapa - cuchillo extraíble de cuatro cuchillas de acero inoxidable - tapón en la tapa para añadir ingredientes durante el funcionamiento - disponible con vaso de lexan o de acero inoxidable. Los modelos dobles tienen un grupo cuchilla y un grupo mezclador.
El modelo FR200P tiene un variador de velocidad.
Accesorios: vaso de acero inoxidable o de lexan para batidos o para granizados.

EN Smoothie & milkshake maker etc. Coated aluminium alloy casing - microswitch on lid - removable four-blade knife in stainless steel - cap on lid to add extra ingredients during processing - available with lexan or stainless steel cup. Dual models are equipped with blades unit and mixing unit.
The FR200P model is equipped with a speed controller.
Optional: Stainless steel or lexan cup for smoothies or milkshakes.

DE Maschine zur Zubereitung von Mixgetränken, Milkshakes usw. Gehäuse aus lackierter Aluminiumlegierung - Mikroschalter auf dem Deckel - abnehmbares Messer mit vier Klingen ausEdelstahl - Öffnung auf dem Deckel für die Zugabe der Zutaten in der Arbeitsphase - erhältlich mit Becher aus Lexan oder Edelstahl. Die Doppelte-Modelle sind mit einer Messergruppe und einer Mixer- Gruppe ausgestattet.
Das Modell FR200P verfügt über einen Geschwindigkeitsregler
Optionals: Becher aus Edelstahl oder Lexan für Mixgetränke oder Milkshakes.











RU Прибор для приготовления коктейлей, фραπε и т.д. Окрашенный корпус из легкого алюминиевого сплава - микровыключатель на крышке - четырехлопастной съемный нож из нержавеющей стали - пробка на крышке для добавления ингредиентов в ходе работы - предлагается в исполнении со стаканом из лексана или из нержавеющей стали. Двухстаканные модели оснащены одним ножевым блоком и одним смесительным.
модель FR200P имеет регулятор скорости
Аксессуары: стакан из нержавеющей стали или из лексана для приготовления коктейлей или фραπε.



FR2150I



FR2150P

	FR150I	FR150P	FR200P	FR2150I	FR2150P
	0,35 kW		0,75 kW	0,35 + 0,35 kW	
	230V/1N/50-60Hz				
	16000 rpm		14000÷24000 rpm	2 x 16000 rpm	
	1,5 L		2 L	1,5 + 1,5 L	
	210 x 210 x 490(h) mm		210 x 215 x 485(h) mm	380 x 210 x 490(h) mm	
					
	4 Kg		5 Kg	8,5 Kg	
	5,4 Kg		6,5 Kg	10 Kg	
	300 x 300 x 530(h) mm			530 x 310 x 530(h) mm	
	0,048 m³			0,087 m³	

Special Voltages - Разное питающее напряжение

Optional

ACCESSORIES
ACCESSOIRES
ZUBEHÖR
ACCESORIOS
AKCECCYAPЫ

	ACB150PL	ACB150PF	ACB150IL	ACB150IF
 1,5 L	Bicchiere lexan gruppo coltelli Lexan container with blades Verre lexan du groupe de couteaux Becher aus Lexan für Messereinheit Vaso de lexan con grupo de cuchillas Стаканы из лексана, узел ножей	Bicchiere lexan gruppo mescolatore Lexan container with shaker Verre lexan du groupe mélangeur Becher aus Lexan für Mixereinheit Vaso de lexan con grupo mezclador Стаканы из лексана, узел смесителя	Bicchiere inox gruppo coltelli Stainless steel container with blades Verre inox du groupe de couteaux Becher ausEdelstahl für Messereinheit Vaso de acero inoxidable con grupo de cuchillas Стаканы из нержавеющей стали, узел ножей	Bicchiere inox gruppo mescolatore Stainless steel container with shaker Verre inox du groupe mélangeur Becher aus Edelstahl für Mixereinheit Vaso de acero inoxidable con grupo mezclador Стаканы из нержавеющей стали, узел смесителя

	ACB200PL	ACB200PF
 2 L	Bicchiere lexan gruppo coltelli - Lexan container with blades Verre lexan du groupe de couteaux - Becher aus lexan für Messereinheit Vaso de lexan con grupo cuchilla - Стаканы из лексана, узел ножей	Bicchiere lexan gruppo mescolatore - Lexan container with shaker Verre lexan du groupe mélangeur - Becher aus lexan für Mixereinheit Vaso de lexan con grupo mezclador - Стаканы из лексана, узел смесителя



ACB150PL



ACB150IF

FP1I-FP1P
FP2I-FP2P



FP1I

FP1P



FP2I















FP2P

Frullatori frappé

MILKSHAKERS
BLENTERS À FRAPPÉS
MILKSHAKER
LICUADORAS FRAPPÉ
БЛЕНДЕРЫ ДЛЯ ПРИГОТОВЛЕНИЯ ФРАППЕ

- IT Macchina per realizzare frappè, cocktails, sorbetti ecc. Struttura in lega di alluminio - disponibile con bicchiere in lexan o acciaio inox - sistema di accensione automatica solo con bicchiere inserito.
- EN Milkshake, cocktail, sherbet , etc. machine. Structure made of aluminium alloy - available with the cup in Lexan or in stainless steel - automatic power on system only with the cup inserted.
- FR Machine pour la préparation de milkshakes, cocktails, sorbets, etc. Corps en alliage d'aluminium - disponible avec verre lexan ou en acier Inox - système d'allumage automatique uniquement avec verre inséré.
- DE Gerät zur Zubereitung von Milchshakes, Cocktails, Sorbets, etc. Gehäuse aus Aluminiumlegierung - erhältlich mit Lexan- oder Edelstahlbecher - automatische Zündung nur mit eingelegtem Becher.
- ES Máquina para realizar batidos, cócteles, sorbetes, etc. Estructura de aleación de aluminio - disponible con vaso de lexan o de acero inoxidable - sistema de encendido automático sólo con el vaso enganchado.
- RU Прибор для приготовления фрэппе, коктейлей, сорбета и т.п. Корпус из легкого алюминиевого сплава, предлагается в исполнении со стаканом из лексана или из нержавеющей стали, автоматическая система включения, срабатывающая только при установленном стакане.

	FP1I	FP1P	FP2I	FP2P
				
	0,12 kW		0,12 + 0,12 kW	
	230V/1N/50-60Hz			
				
	16000 rpm			
				
	0,5 L		0,5 + 0,5 L	
	150 x 195 x 485(h) mm		300 x 195 x 485(h) mm	
				
	2,5 Kg		5 Kg	
	3,5 Kg		6,5 Kg	
	210 x 250 x 570(h) mm		370 x 250 x 530(h) mm	
	0,030 m³		0,049 m³	

Special Voltages - Разное питающее напряжение



SPM
SPL



SPM





SPL

Spremiagrumi

JUICE SQUEEZER
PRESSE-AGRUMES
ZITRUSPRESSE
EXPRIMIDOR
СОКОВЫЖИМАЛКИ
ДЛЯ ЦИТРУСОВЫХ

- IT** Spremiagrumi elettrici professionali in lega di alluminio verniciato - vasca, filtro e pigna estraibili - doppia pigna in ABS alimentare. SPM accensione e spegnimento automatici tramite pressione sulla pigna - SPL accensione e spegnimento automatici tramite l'utilizzo della leva premi-frutta.
- EN** Professional electric juicer in coated aluminium alloy - removable bowl, filter and cone - double cone in alimentary ABS. SPM automatic switching on and off by pressing on the cone - SPL automatic switching on and off by using the fruit-press lever.
- FR** Extracteur de jus électrique professionnel en alliage d'aluminium peint - réservoir amovible, filtre et cône - double cône en ABS alimentaire. SPM: mise en marche et arrêt automatique par pression sur le cône - SPL: mise en marche et arrêt automatique SPL à l'aide du levier de la presse à fruits.
- DE** Professioneller elektrischer Entsafter aus lackierter Aluminiumlegierung - abnehmbarer Behälter, Filter und Kegel - Doppelkegel aus lebensmitteltauglichem ABS. SPM automatisches Ein- und Ausschalten durch Drücken des Kegels - SPL automatisches Ein- und Ausschalten durch Drücken des Fruchtpressenhebels.
- ES** Exprimidores eléctricos profesionales de aleación de aluminio pintado - recipiente, filtro y cono extraíbles - doble cono de ABS de uso alimentario. SPM: encendido y apagado automáticos presionando el cono. SPL: accionamiento y apagado automáticos con la palanca empujadora de la fruta.
- RU** Профессиональная электрическая соковыжималка для цитрусовых из окрашенного алюминиевого сплава - съемные чаша и фильтр - автоматическое включение и выключение путем нажатия на выжимной конус - двойной выжимной конус из пищевого АБС-пластика. SPL: Профессиональная электрическая соковыжималка для цитрусовых из окрашенного алюминиевого сплава - автоматическое включение и выключение при нажатии и отпуске прижимного рычага для фруктов - съемные чаша, фильтр и выжимной конус.

	SPM	SPL
	0,15 kW	
	230V/1N/50-60Hz	
	500 rpm	
	210 x 305 x 330(h) mm	210 x 305 x 365(h) mm
		
	4 Kg	4,5 Kg
	5 Kg	5,5 Kg
	300 x 390 x 440(h) mm	
	0,051 m³	

Special Voltages - Разное питающее напряжение



ROGM
TRL



ROGM



TRL

Tritaghiaccio

ICE CRUSHER
BROYEUR À GLACE
EISMÜHLE
PICADORA DE HIELO
ЛЕДОВАЯ ДРОБИЛКА

IT Tritaghiaccio professionali adatti per la preparazione di granite e cocktails.
ROGM: Struttura in lega di alluminio verniciato - microinterruttore su coperchio - bicchiere e gruppo lame in acciaio inox - regolazione dimensione ghiaccio tritato. Produzione di ghiaccio a pezzi per cocktails.
TRL: Struttura in ABS - microinterruttore su leva - tramoggia in lega leggera - lama in acciaio inox - espulsione ghiaccio a gravità. Produzione di ghiaccio tritato per granite.





EN Professional ice crusher perfect to prepare granite and cocktails.
ROGM: casing in coated aluminium alloy - microswitch on lid - cup and blade group made of stainless steel - crushed ice size adjustment. Production of ice in pieces for cocktails.
TRL: ABS casing - microswitch on lever - light alloy hopper - stainless steel blade - gravity ice ejection. Production of crushed ice for granite.

FR Broyeur à glace professionnel pour la préparation des granites et des cocktails.
ROGM: Structure en alliage d'aluminium verni - microrupteur sur le couvercle - verre et groupe de lames en acier inox - réglage de la taille de la glace pilée. Production de glace en morceaux pour cocktails.
TRL: Structure en ABS - micro-interrupteur sur levier - trémie en alliage léger - lame en acier inox - éjection de glace par gravité. Production de glace concassée pour les granites.

DE Professioneller Eisbrecher für die Zubereitung von Granite und Cocktails.
ROGM: Gehäuse aus lackierter Aluminiumlegierung - Mikroschalter am Deckel - Becher- und Klingengruppe aus Edelstahl - Eisgrößenverstellung. Herstellung von Eis in Stücken für Cocktails.
TRL: Gehäuse aus ABS - Mikroschalter am Hebel - Trichter aus Leichtmetall - Edelstahlklinge - Schwerkraft-Eiswurf. Produktion von Scherbeneis für Granit.

ES Picadoras de hielo profesionales para granizados y cócteles. deshacer el hielo en delicadas.
ROGM: estructura de aleación de aluminio pintado - microinterruptor en la tapa - vaso y grupo cuchillas de acero inoxidable - regulador de la medida del hielo triturado. Produce hielo en pedazos para cócteles.
TRL: Estructura de ABS - microinterruptor en la palanca - tolva de aleación ligera - cuchilla de acero inoxidable - expulsión del hielo por gravedad. Produce hielo tridurado para granizados.

RU Профессиональная дробилка для измельчения льда, подходящая для приготовления гранита и коктейлей.
ROGM: Конструкция из окрашенного алюминиевого сплава - микро-выключатель на крышке - стекло и группа лопаток из нержавеющей стали - регулировка размера измельченного льда. Производство льда кусочками для коктейлей.
TRL: Структура ABS - микровыключатель на рычаге - бункер из легкого сплава - лезвие из нержавеющей стали - гравитационный выброс льда. Производство щебня для гранита.

	ROGM	TRL
	0,15 kW	0,35 kW
	230V/1N/50-60Hz	
	800 rpm	1200 rpm
	~120 Kg/h	
	3 L	-
	210 x 380 x 490(h) mm	210 x 465 x 310(h) mm
		
	5 Kg	8 Kg
	6 Kg	9 Kg
	300 x 300 x 530(h) mm	280 x 540 x 310(h) mm
	0,047 m³	0,046 m³

Special Voltages - Разное питающее напряжение

GP2SF
GP2FR
GP3SFF



GP2SF



GP3SFF

Gruppi multipli

MULTIPLE GROUP
GROUPE MULTIPLE
MULTI-EINHEIT
GRUPO MÚLTIPLE
БАРНЫЙ КОМБАЙН

IT Macchine per realizzare contemporaneamente più lavorazioni.
Struttura in lega leggera di alluminio verniciato - motori indipendenti.
GP2SF: composto da spremiagrumi e frullatore con bicchiere da 1,5 L in lexan.
GP2FR: composto da frullatore con bicchiere da 1,5 L in lexan e rompighiaccio con bicchiere in acciaio inox.
GP3SFF: composto da spremiagrumi a leva, frullatore con bicchiere da 1,5 L in lexan e frappè con bicchiere in lexan.





EN Multi-purpose appliances. Painted aluminium alloy casing - independent motors.
GP2SF: composed of a citrus juicer and mixer with 1.5 L lexan cup.
GP2FR: composed of a mixer with 1.5 L lexan cup and ice crusher with stainlesssteel cup.
GP3SFF: composed of a citrus juicer, mixer with 1.5 L lexan cup and milkshaker with lexan cup.

FR Machines pour préparer simultanément plusieurs recettes.
Corps en alliage d'aluminium léger verni - moteurs indépendants.
GP2SF: composé d'une presse-fruits et d'un mélangeur avec verre lexan de 1,5 L.
GP2FR: composé d'un mixer avec verre lexan de 1,5 L et d'un brise-glace avec verre en acier Inox.
GP3SFF: composé d'un presse-fruits à levier, d'un mixeur avec verre de 1,5 L en lexan et mixeur Milkshakes avec verre lexan.

DE Machines pour préparer simultanément plusieurs recettes.
Corps en alliage d'aluminium léger verni - moteurs indépendants.
GP2SF: composé d'une presse-fruits et d'un mélangeur avec verre lexan de 1,5 L.
GP2FR: composé d'un mixer avec verre lexan de 1,5 L et d'un brise-glace avec verre en acier Inox.
GP3SFF: composé d'un presse-fruits à levier, d'un mixeur avec verre de 1,5 L en lexan et mixeur Milkshakes avec verre lexan.

ES Máquinas para varias preparaciones simultáneas.
Estructura de aleación ligera de aluminio pintado - motores independientes.
GP2SF: compuesto por exprimidor y batidora con vaso de 1,5 L de lexan.
GP2FR: compuesto por batidora con vaso de 1,5 L de lexan y rompe hielo con vaso de acero inoxidable.
GP3SFF: compuesto por exprimidor, batidora con vaso de 1,5 L de lexan y batidoras para batidos con vaso de lexan.

RU Машины для одновременного выполнения различных типов обработки. Окрашенный корпус из легкого алюминиевого сплава - независимые двигатели.
GP2SF: состоит из соковыжималки для цитрусовых и блендера со стаканом объемом 1,5 л из лексана.
GP2FR: состоит из блендера со стаканом объемом 1,5 л из лексана и льдодробителя со стаканом из нержавеющей стали.
GP3SFF: состоит из соковыжималки для цитрусовых, блендера со стаканом объемом 1,5 л из лексана и прибор для приготовления фрэппе со стаканом из лексана.

	GP2SF	GP2FR	GP3SFF
			
	0,15 + 0,35 kW		0,15 + 0,35 + 0,12 kW
	230V/1N/50-60Hz		
	500 - 16000 rpm	800 - 16000 rpm	500 - 16000 - 16000 rpm
	380 x 240 x 490(h) mm	380 x 300 x 490(h) mm	510 x 240 x 500(h) mm
			
	9 Kg		11 Kg
	10 Kg		12 Kg
	530 x 310 x 530(h) mm		
	0,087 m³		

Special Voltages - Разное питающее напряжение



GP2FR

TOP2DN
TOP3DN
TOP6DN



TOP3DN



TOP6DN

New

Tostiere
serie TOP

TOASTER
GRILLE-PAIN
TOASTER
TOSTADORA
TOCTEP

IT Macchina per riscaldare pizze, panini, cibi precotti, hamburger, würstel, toast farciti, piadine, ecc. Struttura in acciaio inox - funzionamento mediante resistenze con tubi al quarzo - timer 0÷15 minuti - capacità toast 2 (mod. TOP2DN), 3 (mod. TOP3DN) e 6 (mod. TOP6DN).

FR Machine pour chauffer les pizzas, les petits pains, les aliments précuits, les steak hachés, les saucisses de Francfort, les toasts farcis, les piadine, etc. Corps en acier inox - fonctionnement par résistances à tubes au quartz - minuterie de 0 à 15 minutes - capacité de chauffe de 2 toasts (mod. TOP2DN), 3 (mod. TOP3DN) et 6 (mod. TOP6DN).

ES Máquina para calentar pizzas, bocadillos, alimentos pre-cocinados, hamburguesas, salchichas, tostadas, piadina (tortilla de pan ácimo), etc. Estructura de acero inoxidable - funcionamiento por medio de resistencias con tubos de cuarzo - temporizador 0÷15 minutos. Capacidad 2 tostadas (mod. TOP2DN), 3 (mod. TOP3DN) e 6 (mod. TOP6DN).

EN Machine to heat pizzas, sandwiches, precooked foods, hamburger, sausages, stuffed toast, piadine, etc. Stainless steel casing - quartz tube heating element operation - timer from 0 to 15 minutes - heating capacity of 2 toasts (mod. TOP2DN), 3 toasts (mod. TOP3DN) and 6 toasts (mod. TOP6DN).











DE Maschine zum Erhitzen von Pizza, belegten Broten, vorgekochten Speisen, Würsten, gefüllten Toasts, Fladenbrot usw. Gehäuse aus Edelstahl - Betrieb mittels Widerstände mit Quarzrohren - Timer 0÷15 Minuten. Toastkapazität 2 (mod. TOP2DN), 3 (mod. TOP3DN) und 6 (mod. TOP6DN).

RU Машина для разогрева пиццы, сэндвичей, полуфабрикатов, гамбургеров, колбас, фаршированных тостов, пиадин и др. Корпус из нержавеющей стали - кварцевый трубчатый нагревательный элемент - таймер от 0 до 15 минут - мощность нагрева 2 тостов (mod. TOP2DN), 3 тостов (модель TOP3DN) и 6 тостов (модель TOP6DN).



TOP2DN



	TOP2DN	TOP3DN	TOP6DN
	1,7 kW	2,2 kW	3,3 kW
	230V/1N/50-60Hz		
	Meccanico - Mechanical - Механический 0÷15'		
	250 x 230 x 65(h) mm	350 x 250 x 60(h) mm	350 x 250 x 60(h) mm x 2
	415 x 300 x 250(h) mm	535 x 300 x 250(h) mm	535 x 300 x 360(h) mm
			
	7 Kg	7,5 Kg	9,5 Kg
	8,5 Kg	10,5 Kg	12,5 Kg
	510 x 330 x 410(h) mm	640 x 510 x 410(h) mm	
	0,069 m³	0,134 m³	

Special Voltages - Разное питающее напряжение

ACGRITOPD

Griglia - Grill - Grille - Rost - Parrilla - Решётка
(only for TOP3DN-TOP6DN)



TOP2DN

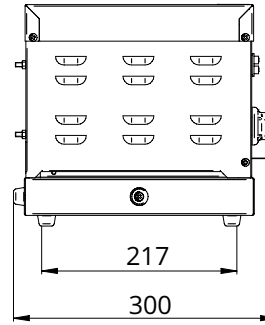
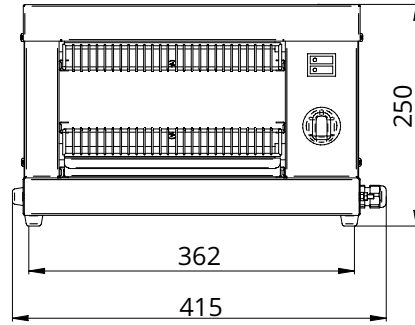

TOP3DN

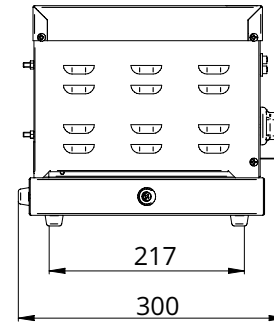
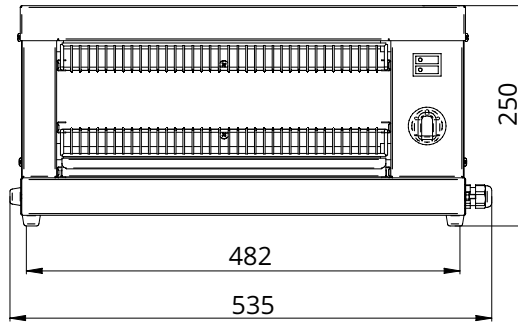

TOP6DN

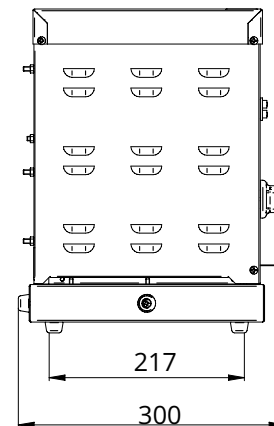
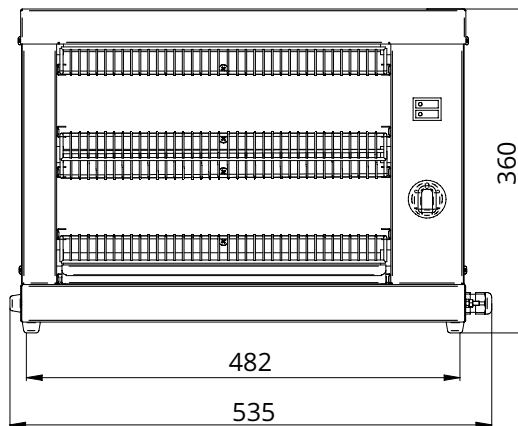

TOCS
TOC



TOC

Tostapane continuo

CONTINUOUS TOASTER
GRILLE-PAIN CONTINU
DURCHLAUF-TOASTER
TOSTADORA DE PAN CONTINUA
НЕПРЕРЫВНЫЙ ТОСТЕР

- IT** Macchina per tostare fette di pane a ciclo continuo. Struttura in acciaio inox - tappeto di tostatura girevole in acciaio inox - camera di cottura rivestita in materiale isolante - motore autoventilato con riduttore incorporato - regolazione velocità scorrimento tappeto di cottura - funzionamento mediante resistenze con tubi al quarzo - accensione tubi a blocchi per meglio impostare il calore desiderato - ventola di dissipazione calore.
- EN** Continuous bread slice toaster. Stainless steel casing - rotating stainless steel toasting mat - cooking chamber coated with insulating material - self-ventilating motor with built-in gear motor - toasting mat sliding speed adjustment - resistance function with quartz tubes - block tube power to better set required heat - heat dissipation fan.
- FR** Machine pour griller les tranches de pain en continu. Corps en acier inox - tapis de grillage rotatif en acier inox - chambre de cuisson revêtue de matériel isolant - moteur auto ventilé avec réducteur incorporé - réglage de vitesses à coulissement du tapis de cuisson - fonctionnement par résistances à tubes au quartz - mise en marche avec tubes à blocages pour mieux programmer la chaleur voulue - ventilateur de dissipation de chaleur.
- DE** Maschine zum Toasten von Brotscheiben im Dauerzyklus. Gehäuse aus Edelstahl - drehbare Toastfläche aus Inox-Stahl - Garkammer mit Isoliermaterialbeschichtung - Motor mit Eigenbelüftung und eingebautem Getriebe - Einstellung der Toastflächen-Laufgeschwindigkeit - Betrieb mittels Widerstände mit Quarzrohren - Blockeinschaltung der Rohre zur besseren Einstellung der gewünschten Hitze - Wärmeableitungsventilator.
- ES** Máquina para tostar rebanadas de pan en proceso continuo. Estructura de acero inoxidable - tapete giratorio de acero inoxidable para tostar - cámara de cocción revestida con material aislante - motor con autoventilado y reductor incorporado - regulación velocidad deslizamiento tapete de cocción - funcionamiento por medio de resistencias con tubos de cuarzo - encendido de tubos en bloques para regular el calor necesario - ventilador para disipar el calor.
- RU** Прибор для обжаривания хлеба в непрерывном режиме. Каркас из нержавеющей стали, поворотная обжарочная поверхность из нержавеющей стали, жарочная камера облицована изолирующим материалом, самовентилируемый двигатель со встроенным редуктором, регулировка скорости обжарочной поверхности, нагревательные элементы с кварцевыми трубками, поблочное включение трубок для оптимального задания температуры, вентилятор для распределения тепла.

	TOCS	TOC
	2,6 kW	3 kW
 1 Ph	230V/1N/50-60Hz	
 mm	220 x 330 mm	305 x 410 mm
 Kg/h	80÷360 (n°)	150÷480 (n°)
	75÷270"	100÷360"
 mm	370 x 480 x 340(h) mm	450 x 680 x 390(h) mm
		
 NET Kg	16 Kg	22 Kg
 GROSS Kg	18 Kg	25 Kg
 mm	420 x 560 x 450(h) mm	550 x 720 x 480(h) mm
 m ³	0,106 m ³	0,190 m ³

Special Voltages - Разное питающее напряжение

PV27LL-PV27LR
PV40LL-PV40LR
PV55LL-PV55LR



PV27LL



PV40LR

Piastra elettrica
in vetroceramica

PYROCERAM GRILLS
PLAQUE EN VITROCÉRAMIQUE
GLASKERAMIKPLATTEN
PLACAS DE VITROCERÁMICA
СТЕКЛОКЕРАМИЧЕСКАЯ ПЛИТА

IT Macchina per cuocere e riscaldare carne, pesce, uova, verdura, formaggi, toast farciti, panini, ecc. Struttura in acciaio inox - piastra in vitroceramica tipo "eurokera" - resistenze ad infrarossi. Piastre superiori auto-bilanciate, lisce o rigate - piastra inferiore liscia, spessore 5 mm - isolamento termico in fibroceramica - impianto elettrico in silicovetro - termostato di sicurezza.

FR Les plaques électriques en vitrocéramique sont indiquées pour le chauffage de sandwiches et pour la cuisson de viande, poisson, légumes, etc.. Grace à l'utilisation des éléments à infrarouge, elles peuvent rejoindre la température programmée rapidement. La structure en acier inox et les plaques de cuisson en vitrocéramique eurokera permettent un nettoyage très facile. Plaques supérieures auto-balançées, lisses ou rainurées - plaque inférieure lisse, épaisseur 5 mm - isolation thermique en fibre-céramique - installation électrique en vitre-silicone - thermostat de sécurité.













ES Máquina para cocinar y calentar carne, pescados, huevos, verdura, queso, tostadas, bocadillos. Estructura de acero inoxidable - placas de cocción vitrocerámicas "eurokera" - resistencias de infrarrojos. Placas superiores auto-equilibradas, lisas o rayadas - placa inferior lisa, espesor 5 mm - aislamiento térmico de fibrocerámica - instalación eléctrica de vidrio siliconado - termostato de seguridad.

EN The electric contact grill in glass ceramic are suitable to warm sandwiches up and to cook meat, fish, vegetables, etc.. Thanks to the utilisation of the infrared elements, they rapidly reach the temperature set. The stainless steel structure and the glass ceramic cooking surfaces by eurokera make the cleaning operation very easy. Auto-balanced upper surfaces, smooth or ribbed - smooth bottom surface, 5 mm thick - thermal insulation in ceramic-fibre - electrical system in silicon-glass - safety thermostat.

DE Die Elektroplatten aus Glaskeramik werden zum Rösten von Toastbrot und Brötchen und zum Kochen von Fleisch, Fisch, Gemüse, usw. verwendet. Dank dem Gebrauch von Infrarotheizelementen erreichen sie die eingestellte Temperatur äußerst schnell. Dank des Gehäuse aus Edelstahl und den Kochplatten aus Glaskeramik eurokera sind sie äußerst einfach zu reinigen. Glatte oder gestreifte selbstaushleichende obere Platten - Glatte untere Platte, Dicke 5 mm - Wärmeisolierung aus Keramikfaser - Elektroanlage aus Siliconglas - Sicherheitsthermostat.

RU Электрические стеклокерамические плиты предназначены для быстрого разогревания тостового хлеба и бутербродов или приготовления мяса, рыбы, овощей и т.д. Они быстро достигают заданной температуры благодаря инфракрасным сопротивлениям. Корпус из нержавеющей стали и плиты из стеклокерамики eurokera способствуют быстрой очистке при уходе. Верхние плиты с автоматической балансировкой и гладкой или рифлёной жарочной поверхностью - гладкая нижняя плита толщиной 5 мм - теплоизоляция из фиброкерамики - электропроводка из стеклосиликона - предохранительный термостат.



	PV27LL	PV27LR	PV40LL	PV40LR	PV55LL	PV55LR
	1,7 kW		2 kW		3,4 kW	
	-				400V/3N/50-60Hz	
	230V/1N/50-60Hz					
	270 x 300 mm		400 x 300 mm		550 x 300 mm	
	Liscia-Liscia Smooth-Smooth Гладкий-Гладкий	Liscia-Rigata Smooth-Grooved Гладкий / Рифлёный	Liscia-Liscia Smooth-Smooth Гладкий-Гладкий	Liscia-Rigata Smooth-Grooved Гладкий / Рифлёный	Liscia-Liscia Smooth-Smooth Гладкий-Гладкий	Liscia-Rigata Smooth-Grooved Гладкий / Рифлёный
	50±300°C					
	340 x 450 x 190/600(h) mm		490 x 450 x 190/600(h) mm		630 x 450 x 190/600(h) mm	
						
	11,5 Kg		15,5 Kg		23 Kg	
	13,5 Kg		17 Kg		32 Kg	
	430 x 540 x 270(h) mm		530 x 580 x 360(h) mm		730 x 530 x 410(h) mm	
	0,062 m³		0,110 m³		0,159 m³	

Special Voltages - Разное питающее напряжение

La superficie di cottura inferiore è sempre liscia.
 The lower cooking surface is always smooth.
 La surface de cuisson inférieure est toujours lisse.
 Die untere Kochfläche ist immer glatt.
 La superficie de cocción inferior es siempre lisa.
 Нижняя варочная поверхность всегда гладкая.

PE25NL-PE25NR
PE35NL-PE35NR
PE50NL-PE50NM-PE50NR

Piastra elettrica in ghisa



PE50NR



PE25NL

CAST IRON ELECTRICAL GRILLS
PLAQUES ELECTRIQUES EN FONTE
GUSSEISENELEKTROPLATTEN
PLACAS ELÉCTRICAS DE FUNDICIÓN
ЭЛЕКТРИЧЕСКИЕ ПЛИТЫ

IT Macchina per cuocere e riscaldare carne, pesce, uova, verdura, formaggi, toast farciti, panini, ecc. Struttura in acciaio inox - piastra di cottura in ghisa sabbiata, in grado di mantenere a lungo la temperatura - resistenze a contatto con le piastre per garantire una migliore conducibilità - termostato di sicurezza - piastra superiore auto-bilanciata - la superficie di cottura superiore è sempre rigata - disponibili con piano di cottura liscio o rigato.

FR Machine pour cuire et chauffer la viande, le poisson, les oeufs, les légumes, les fromages, les toasts farcis, les petits pains, etc. Corps en acier inox - plaque de cuisson en fonte sablée, en mesure de conserver longtemps la température - résistances en contact avec les plaques pour garantir une meilleure conduction - thermostat de sécurité - plaque supérieure auto équilibrée - la surface de cuisson supérieure est toujours nervuré - disponibles avec plan de cuisson lisse ou nervuré.

ES Máquina para cocinar y calentar carne, pescados, huevos, verdura, queso, tostadas, bocadillos. Estructura de acero inoxidable - placa de cocción de hierro fundido arenado, que permite mantener la temperatura - resistencias en contacto con las placas para la mejor conductibilidad - termostato de seguridad. La superficie de cocción superior siempre es rayada. Diponible con plano de cocción liso o rayado.

EN Machine for cooking and heating meat, fish, eggs, vegetables, cheese, stuffed toast, sandwiches, etc. Stainless steel casing - sandblasted cast iron cooking plate, which maintains the temperature for a long time - heating elements placed directly on the plates to guarantee better conductivity - safety thermostat - selfbalanced upper plate - the upper cooking surface is always ribbed - available with smooth or ribbed cooking surface.

DE Maschine zum Garen und Erhitzen von Fleisch, Fisch, Eiern, Gemüse, Käse, gefüllten Toasts, Broten usw. Gehäuse aus Edelstahl - Kochplatte aus sandgestrahltem Gusseisen, geeignet zur langfristigen Beibehaltung der Temperatur - Heizelemente zur besseren Wärmeleitfähigkeit - Sicherheitsthermostat - obere selbsttätige ausbalancierte Platte - Die obere Kochfläche ist immer gerillt - erhältlich mit glatter oder gerillter Kochfläche.













RU Прибор для приготовления и разогревания мяса, рыбы, овощей - сыров, сэндвичей - бутербродов и т.п. Корпус из нержавеющей стали - жарочная плита из чугуна с пескоструйной обработкой - которая способна сохранять тепло в течение длительного времени - нагревательные элементы - контактирующие с плитами для обеспечения лучшей проводимости - предохранительный термостат- Верхняя варочная поверхность всегда рифлёная - жарочная плита предлагается гладкой или рифленой.



PE35NR



PE50NL

	PE25NL	PE25NR	PE35NL	PE35NR	PE50NL	PE50NR	PE50NM
	1,8 kW		2,2 kW		3,6 kW		
	-				400V/3N/50-60Hz		
	230V/1N/50-60Hz						
	240 x 230 mm		340 x 230 mm		480 x 230 mm		
	Liscia-Rigata Smooth-Grooved Гладкий / Рифлёный	Rigata-Rigata Grooved-Grooved Рифлёный-Рифлёный	Liscia-Rigata Smooth-Grooved Гладкий / Рифлёный	Rigata-Rigata Grooved-Grooved Рифлёный-Рифлёный	Liscia-Rigata Smooth-Grooved Гладкий-Рифлёный	Rigata-Rigata Grooved-Grooved Рифлёный- Рифлёный	Mista-Rigata Mixed-Grooved Смешанный- Рифлёный
	50+300°C						
	320 x 360 x 200/520(h) mm		420 x 360 x 200/520(h) mm		570 x 360 x 200/520(h) mm		
							
	16 Kg		22 Kg		27 Kg		
	18 Kg		24 Kg		34 Kg		
	450 x 460 x 300 (h) mm		560 x 470 x 300(h) mm		690 x 450 x 380(h) mm		
	0,062 m³		0,079 m³		0,118 m³		

Special Voltages - Разное питающее напряжение

La superficie di cottura superiore è sempre rigata.
 The upper cooking surface is always ribbed.
 La surface de cuisson supérieure est toujours nervurée.
 Die obere Kochfläche ist immer gerillt.
 La superficie de cocción superior siempre es rayada.
 Верхняя варочная поверхность всегда рифлёная.

CRPN-CRP2N
CRP4-CRP42



CRPN



CRP2N

Crepiere
elettriche

ELECTRIC CRÊPES MACHINES
CRÊPIÈRES ÉLECTRIQUES
ELEKTRISCHE CRÊPES-MASCHINEN
MÁQUINA PARA CREPES ELÉCTRICA
ЭЛЕКТРИЧЕСКИЕ - ГАЗОВЫЕ БЛИННИЦЫ

IT Macchine per la preparazione di crepes dolci o salate. Struttura in acciaio inox - piastra di cottura in ghisa con superficie multirighe antiscivolo - disponibili con una o due piastre di cottura - tempo di cottura da 1 a 3' circa - termostato per la regolazione temperatura su ogni piastra - piastre doppie con funzionamento indipendente.













EN Machines for the preparation of sweet or savoury crepes. Stainless steel casing - cast iron cooking plate with non-slip multi-line surface - available with one or two cooking plates - cooking time from about 1 to 3' - thermostat for the temperature regulation on each plate - double plates with independent operation.

FR Corps en acier inox - plaque de cuisson en fonte avec surface à plusieurs nervures antidérapante - disponibles avec une ou deux plaques de cuisson - temps de cuisson d'environ 1 à 3 minutes - thermostat de réglage de température sur chaque plaque - plaques doubles avec fonctionnement indépendant.

DE Gehäuse aus Edelstahl. Kochplatte aus Gusseisen mit rutschfester Mehrfachrillenoberfläche - erhältlich mit einer oder zwei Kochplatten - Garzeit von ca. 1 bis 3' - Thermostat zur Einstellung der Temperatur auf jeder Platte - Doppelplatten mit unabhängigem Betrieb.

ES Máquina para preparar crepes dulces o saladas. Estructura de acero inoxidable - placa de cocción de fundición con superficie multirayada antideslizante - disponible con una o dos placas de cocción - tiempo de cocción de 1 a 3 minutos - termostato para la regulación de la temperatura de cada placa - placas dobles con funcionamiento independiente.

RU Корпус из нержавеющей стали, жарочная поверхность из чугуна с пескоструйной обработкой с насечками против скольжения, в исполнении с одной или двумя жарочными поверхностями, время приготовления от 1 до 3 минут - термостат для регулировки температуры каждой жарочной поверхности, две независимо работающие жарочные поверхности.

	CRPN	CRP2N	CRP4	CRP42
				
	2 kW	2 + 2 kW	2,75 kW	2,75 + 2,75 kW
	-	400V/3N/50-60Hz	-	400V/3N/50-60Hz
	230V/1N/50-60Hz	-	230V/1N/50-60Hz	-
	ø 350 mm	ø 350 mm x 2	ø 400 mm	ø 400 mm x 2
	50±300°C			
	400 x 470 x 120(h) mm	810 x 470 x 120(h) mm	400 x 470 x 120(h) mm	810 x 470 x 120(h) mm
				
	11 Kg	21 Kg	16 Kg	29 Kg
	13 Kg	28 Kg	18 Kg	35 Kg
	590 x 530 x 220(h) mm	950 x 530 x 340(h) mm	590 x 530 x 220(h) mm	950 x 530 x 340(h) mm
	0,046 m³	0,074 m³	0,070 m³	0,187 m³

Special Voltages - Разное питающее напряжение



CRP4

CR400G1
CR400G2



CR400G1



CR400G2

Crepiere a gas

GAS CRÊPES MACHINES
CRÊPIÈRES À GAZ
GAS CRÊPES-MASCHINEN
MÁQUINA PARA CREPES DE GAS
ГАЗОВЫЕ БЛИННИЦЫ

IT Macchine per la preparazione di crepes dolci o salate. Struttura in acciaio inox - piastra di cottura in ghisa con superficie multirighe antiscivolo - disponibili con una o due piastre di cottura - alimentazione a GPL, in dotazione kit metano - regolatore potenza fiamma con otto posizioni - accensione con piezoelettrico - piedini regolabili - piastre doppie con funzionamento indipendente - temperatura di cottura da 1 a 3' circa - allacciamento gas standard 1/2"G.















EN Machines for the preparation of sweet or savoury crepes. Stainless steel casing - cast iron cooking plate with non-slip multi-line surface - available with one or two cooking plates - LPG power supply, supplied with natural gas set - eight position flame power regulator - piezoelectric ignition - adjustable feet - double hobs with independent operation - cooking time from approx. 1 to 3' - standard gas connection 1/2"G.

FR Corps en acier inox - plaque de cuisson en fonte avec surface à plusieurs nervures antidérapante - disponibles avec une ou deux plaques de cuisson - Alimentation GPL, fournie avec kit gaz naturel - Régulateur de puissance de flamme à huit positions - allumage avec piézoélectrique - pieds réglables - tables de cuisson doubles avec fonctionnement indépendant - temps de cuisson d'env. 1 à 3' - raccordement gaz standard 1/2"G.

DE Gehäuse aus Edelstahl. Kochplatte aus Gusseisen mit rutschfester Mehrfachrillenoberfläche - erhältlich mit einer oder zwei Kochplatten - LPG-Versorgung, geliefert mit Erdgas-Kit - Flammenleistungsregler mit acht Positionen - Zündung mit Piezoelektrik - verstellbare Füße - Doppelkochfelder mit unabhängiger Bedienung - Garzeit von ca. 1 bis 3' - Standard-Gasanschluss 1/2"G.

ES Máquina para preparar crepes dulces o saladas. Estructura de acero inoxidable - placa de cocción de fundición con superficie multirayada antideslizante - disponible con una o dos placas de cocción - alimentación con GPL, en la dotación kit para metano - regulador de la potencia de la llama con ocho opciones - encendido piezoeléctrico - pies regulables - placas dobles con funcionamiento independiente - temperatura de cocción de 1 a 3 minutos - conexión gas estándar 1/2"G.

RU Машины для приготовления сладких или соленых блинчиков. Корпус из нержавеющей стали, жарочная поверхность из чугуна с пескоструйной обработкой с насечками против скольжения, в исполнении с одной или двумя жарочными поверхностями, работа на сжиженном природном газе, в комплекте с оснасткой для работы на метане, 8-позиционный регулятор интенсивности пламени, пьезоэлектрическое зажигание, регулируемые ножки, две независимо работающие жарочные поверхности - температура приготовления прикл. от 1 до 3' - стандартное газовое соединение 1/2"G.

	CR400G1	CR400G2
	3,6 kW	3,6 + 3,6 kW
	50±280°C	
	3600 kcal/h 14286 BTU/h	3600 + 3600 kcal/h 14286 + 14286 BTU/h
	G20 = 0,34 m³/h G25 = 0,41 m³/h	G20 = 0,34 + 0,34 m³/h G25 = 0,41 + 0,41 m³/h
	G30/G31 = 0,23 Kg/h	G30/G31 = 0,23 + 0,23 Kg/h
	N° 1 (Bruciatori - Burners - горелки)	N° 2 (Bruciatori - Burners - горелки)
	N° 1 (Piezoelettrico - Piezoelectric Пьезоэлектрический)	N° 2 (Piezoelettrico - Piezoelectric Пьезоэлектрический)
	ø 400 mm	ø 400 mm x 2
	480 x 480 x 270(h) mm	900 x 480 x 270(h) mm
		
	23 Kg	46 Kg
	26 Kg	52 Kg
	530 x 530 x 330(h) mm	960 x 540 x 450(h) mm
	0,093 m³	0,233 m³

WD3



WD3

Cuoci Hot Dog

HEAT AND COOK HOT DOGS
CUISEUR À HOT-DOG
HOT-DOG-KOCHER
COCINA PARA PERROS CALIENTES
ПРИГОТОВЛЕНИЯ ХОТ-ДОГОВ

- IT Macchine per riscaldare wurstel e cuocere panini. Struttura in acciaio inox - tre punzoni per riscaldare il pane - termostato 30÷90°C - campana in vetro con all'interno cestello inox per cottura wurstel a bagno maria.
- EN Machines for heating sausages and cooking hot dog buns. Stainless steel casing - three buns heating plots - thermostat from 30 to 90°C - glass cylinder with internal stainless steel bowl to heat sausages in a water bath.
- FR Machine pour le chauffage de saucisses et la cuisson de petits pains. Corps en acier inoxydable - trois broches pour chauffer le pain - thermostat de 30 à 90°C - cylindre en verre avec bac interne en acier inoxydable pour chauffer les saucisses au bain marie.
- DE Maschine zum Erhitzen von Würstchen und Brötchen. Gehäuse aus Edelstahl - drei Heizstiften zum Erwärmen des Brotes - Thermostat von 30 bis 90°C - Glaszylinder mit innenliegender Edelstahlwanne fürs Heizen von Würsten im Wasserbad.
- ES Máquina para calentar salchichas y cocinar pan. Estructura de acero inoxidable - tres punzones para calentar el pan - termostato 30÷90°C - campana de vidrio con cesta interna de acero inoxidable para calentar salchichas en baño maría.
- RU Прибор для разогревания и приготовления булочек и сосисок. Корпус из нержавеющей стали, три штыря для разогревания булочек, термостат на 30÷90°C, стеклянный колпак, внутри которого помещена корзинка из нержавеющей стали для приготовления сосисок на пару.

	WD3
	1,1 kW
 1 Ph	230V/1N/50-60Hz
	30÷90°C
	480 x 300 x 350(h) mm
	
 NET Kg	10 Kg
 GROSS Kg	11 Kg
 mm	540 x 350 x 380(h) mm
 m ³	0,072 m ³

Special Voltages - Разное питающее напряжение



PGEL



ACPGELTA

ACPGELAS







ACPGELSP

Pressagelato

ICE CREAM PRESS
PRESSE-GLACE
EISPRESSE
PRENSADOR PARA HELADO
ПРЕСС ДЛЯ МОРОЖЕНОГО

- IT** Macchina per pressare il gelato in grado di ottenere diversi tipi di forme come spaghetti, tagliatelle o asparagi grazie all'utilizzo di diversi bicchieri. Struttura in alluminio - bicchiere in lega speciale anodizzata - dotato di bicchiere per spaghetti.
Optional: bicchiere tagliatelle, bicchiere asparagi e bicchiere spaghetti.
- EN** Manual small press to make ice-cream spaghetti, tagliatelle or asparagus using different cups. Aluminium casing - special anodized alloy cup - equipped with spaghetti cup.
Optional: tagliatelle, asparagus and spaghetti cup.
- FR** Petite presse manuelle qui permet d'obtenir des spaghettis, des tagliatelles ou des asperges de glace à l'aide de différents récipients. Corps en aluminium - verre en alliage spécial anodisé - muni de verres pour spaghetti. Accessoire: verre à tagliatelle, verre à asperges et verre à spaghetti.
- DE** Kleine manuelle Presse zur Herstellung von Spaghetti-, Tagliatelle- oder Spargeleis durch verschiedene Bechern. Aluminiumgehäuse - spezieller eloxierter Aluminiumbecher - ausgestattet mit Spaghettibecher. Zubehör: Tagliatelle, Spargelbecher und Glas für Spaghetti.
- ES** Pequeño prensador manual para moldear el helado y obtener fideos, tallarines o espárragos de helado, dependiendo del vaso que se usa. Estructura de aluminio - vaso de aleación especial anodizada - Vaso para fideos. Accesorios: Vaso para tallarines, vaso para espárragos y vaso para espagueti.
- RU** Небольшой ручной пресс при помощи которого, используя различные стаканы, можно получить мороженое различных форм типа "спагетти", "лапша" или "спаржа". Алюминиевый каркас, стакан из специального сплава с анодированием, оснащен стаканом для "спагетти".
Аксессуары: стакан для мороженого типа "лапша", стакан для мороженого типа "спаржа" и бокал для спагетти.



	PGEL
	205 x 245 x 520(h) mm
	
	3 Kg
	4 Kg
	230 x 220 x 520(h) mm
	0,026 m ³

	ACPGELAS
	Bicchiere per asparagi - Asparagus cup - Verre à asperges Spargelbechern - Vaso para espárragos - Stakan для "спаржи"

	ACPGELTA
	Bicchiere per tagliatelle - Tagliatelle cup - Verre à tagliatelle Tagliatellebechern - Vaso para tallarines - Stakan для "тальятелле"

	ACPGELSP
	Bicchiere per spaghetti - spaghetti cup - verre à spaghetti Glas für Spaghetti - Vaso para espagueti - бокал для спагетти



Lavaggio

WASH
LAVER
WASCHEN
СТИРАТЬ

IT

Fimar Group a completamento della sua gamma di macchinari per la ristorazione introduce una piccola sezione dedicata al lavaggio dove è possibile trovare: lavastoviglie, lavabicchieri, cestelli ed accessori vari per offrire un servizio completo ai nostri clienti.

FR

Pour compléter sa gamme de machines pour la restauration, Fimar Group propose une petite section dédiée au lavage où vous trouverez : des lave-vaisselle, des lave-verres, des paniers et divers accessoires pour offrir un service complet à nos clients.

ES

Para completar su gama de maquinaria de hostelería, Fimar Group introduce una breve sección dedicada al lavado donde podrá encontrar: lavavajillas, lavavasos, cestas y todo tipo de accesorios para ofrecer un servicio completo a nuestros clientes.

EN

To complete its range of catering equipment, Fimar Group has introduced a small section dedicated to washing where you will find: dishwashers, glasswashers, baskets and a variety of accessories to offer a complete service to our customers.

DE

Zur Vervollständigung des Angebots an Catering-Maschinen führt die Fimar-Gruppe einen kleinen Bereich ein, der dem Spülen gewidmet ist und in dem Sie Geschirrspüler, Gläser-spüler, Körbe und zahlreiches Zubehör finden, um unseren Kunden einen kompletten Service zu bieten.

RU

Fimar Group расширяет свой ассортимент оборудования для ресторанного бизнеса и представляет небольшой раздел по мойке, где вы найдете посудомоечные машины, моечные машины для стекол, корзины и разнообразные аксессуары, чтобы предоставить полный спектр услуг нашим клиентам.

LABI35N
LABI35PLN
LABI40N
LABI40PLN

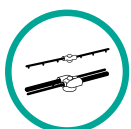

UP/DOWN



MAX H.250 MM (LABI35-PLN)
MAX H.300 MM (LABI40-PLN)



CARICO/SCARICO ACQUA
WATER INLET/DRAIN



LABI35N

Lavabicchieri
cesto quadrato 35x35 / 40x40 cm

GLASSWASHER
LAVE-VERRES
GLÄSERSPÜLMASCHINE
LAVAVASOS
ПОСУДОМОЕЧНАЯ МАШИНА

IT Nuova versione di lavabicchieri con display led a 6 caratteri per la visualizzazione delle temperature di vasca e boiler - pulsante start multi-cromatico - 4 cicli di lavaggio - funzione risparmio energetico - sistema di autodiagnosi - ciclo di autopulizia a fine giornata. Struttura a singola parete in acciaio inox AISI 304 - vasca stampata con angoli arrotondati - porta a doppia parete - bracci di lavaggio e risciacquo in materiale composito facilmente smontabili - microinterruttore su porta - altezza utile lavaggio 25 cm - risciacquo a caldo - funzione Thermostop - valvola antiriflusso di serie - riempimento automatico - dosatore elettrico del brillantante regolabile da display (LABI35N - LABI40N) - con dosatore di detersivo elettrico e pompa di scarico (LABI35PLN - LABI40PLN).
In dotazione: 1 cesto bicchieri 35x35 cm (LABI35N) - 1 cesto bicchieri 40x40 cm (LABI40N) - 1 cesto porta cucchiaini - 1 tubo di carico acqua (lunghezza 2 m) - 1 tubo di scarico (lunghezza 2,5 m).

FR Nouvelle version du lave-verres avec écran LED à 6 caractères pour la visualisation des températures de la cuve et de la chaudière - bouton de démarrage multichrome - 4 cycles de lavage - fonction d'économie d'énergie - système d'autodiagnostic - cycle d'autonettoyage en fin de journée. Structure à simple paroi en acier inox AISI 304 - cuve moulée avec angles arrondis - porte à double paroi - bras de lavage et de rinçage en matériau composite facilement amovibles - micro-interrupteur sur la porte - hauteur utile de lavage 25 cm - rinçage à chaud - fonction Thermostop - soupape anti-reflux de série - remplissage automatique - distributeur de produit de rinçage électrique réglable par l'afficheur (LABI35N - LABI40N) - distributeur de détergent et pompe de vidange (LABI35PLN - LABI40PLN).
Contenu de la livraison: 1 panier en verre 35x35 cm (LABI35N) - 1 panier en verre 40x40 cm (LABI40N) - 1 panier à cuillères - 1 tuyau d'arrivée d'eau (longueur 2 m) - 1 tuyau de vidange (longueur 2,5 m).

















ES Nueva versión de lavavasos con pantalla LED de 6 caracteres para visualizar las temperaturas de la cuba y de la caldera - botón de inicio multicromo - 4 ciclos de lavado - función de ahorro energético - sistema de autodiagnóstico - ciclo de autolimpieza al final del día. Estructura de una sola pared de acero inoxidable AISI 304 - cuba moldeada con esquinas redondeadas - puerta de doble pared - brazos de lavado y aclarado de material compuesto fácilmente extraíbles - microinterruptor en la puerta - altura útil de lavado de 25 cm - aclarado en caliente - función Thermostop - válvula antirreflujo de serie - llenado automático - dosificador de abrillantador eléctrico regulable desde la pantalla (LABI35N - LABI40N) - dosificador de detergente eléctrico y bomba de desagüe (LABI35PLN - LABI40PLN).
Incluye: 1 cesto de cristal 35x35 cm (LABI35N) - 1 cesto de cristal 40x40 cm (LABI40N) - 1 cesto para cucharas - 1 manguera de entrada de agua (longitud 2 m) - 1 manguera de desagüe (longitud 2,5 m).

EN New version of glasswasher with 6-character LED display for display of tank and boiler temperatures - multi-chrome start button - 4 washing cycles - energy saving function - self-diagnosis system - self-cleaning cycle at end of day. Single-wall structure in stainless steel AISI 304 - moulded tank with rounded corners - double-wall door - easily removable washing and rinsing arms in composite material - microswitch on door - useful washing height 25 cm - hot rinsing - Thermostop function - standard anti-reflux valve - automatic filling - electric rinse aid dispenser adjustable from display (LABI35N - LABI40N) - electric detergent dispenser and drain pump (LABI35PLN - LABI40PLN).
Supplied with: 1 glass basket 35x35 cm (LABI35N) - 1 glass basket 40x40 cm (LABI40N) - 1 teaspoon basket - 1 water inlet hose (length 2 m) - 1 drain hose (length 2.5 m).

DE Neue Version der Gläserpülmaschine mit 6-stelligem LED-Display zur Anzeige der Tank- und Kesseltemperatur - mehrfarbige Starttaste - 4 Spülgänge - Energiesparfunktion - Selbstdiagnosesystem - Selbstreinigungszzyklus am Ende des Tages. Einwandige Struktur aus Edelstahl AISI 304 - geformter Tank mit abgerundeten Ecken - doppelwandige Tür - leicht abnehmbare Wasch- und Spülarms aus Verbundwerkstoff - Mikroschalter an der Tür - Nutzhöhe 25 cm - Heißspülung - Thermostop-Funktion - serienmäßiges Rückflussverhinderungsventil - automatische Befüllung - elektrischer Klarspülerspender, der über das Display (LABI35N - LABI40N) - elektrischer Waschmittelspender und Ablaufpumpe (LABI35PLN - LABI40PLN).
Mitgeliefert werden: 1 Gläserkorb 35x35 cm (LABI35N) - 1 Gläserkorb 40x40 cm (LABI40N) - 1 Löffelkorb - 1 Wasserzulaufschlauch (Länge 2 m) - 1 Ablaufschlauch (Länge 2,5 m).

RU Новая версия стекломойки с 6-символьным LED-дисплеем для просмотра температуры бака и бойлера - многоцветная кнопка пуска - 4 цикла мойки - функция энергосбережения - система самодиагностики - цикл самоочистки в конце дня. Одностенная конструкция из нержавеющей стали AISI 304 - литая ванна с закругленными углами - двустенная дверь - легко снимаемые рукоятки для мойки и ополаскивания из композитного материала - микровыключатель на двери - полезная высота мойки 25 см - горячее ополаскивание - функция термостопа - стандартный антирефлюксный клапан - автоматическое наполнение - дозатор ополаскивателя (LABI35N - LABI40N) - Дополнительно оснащена электрическим дозатором моющих средств и сливным насосом, регулируемый от дисплея и сливного насоса (LABI35PLN - LABI40PLN).
Комплект поставки: 1 стеклянная корзина 35x35 см (LABI35N) - 1 стеклянная корзина 40x40 см (LABI40N) - 1 корзина для ложек - 1 шланг для подачи воды (длина 2 м) - 1 сливной шланг (длина 2,5 м).



	LABI35N	LABI35PLN	LABI40N	LABI40PLN
	2,89 kW			
	230V/1N/50Hz			
	0,19 kW			
	90" - 120" - 180" - 9' ciclo / cycle 40 - 30 - 20 - 7 cesti all'ora / baskets for hour			
	10 L			12 L
	2 L			
	2,7 kW			
	3 L			
	2,4 kW			
	440 x 497 x 640(h) mm			455 x 550 x 700(h) mm
				
	33,5 Kg			
	39 Kg			40,5 Kg
	530 x 590 x 790(h) mm			540 x 630 x 850(h) mm
	0,25 m³			0,29 m³

* Con dosatore di detersivo elettrico e pompa di scarico
 With electric detergent dispenser and drain pump
 Дополнительно оснащена электрическим дозатором
 моющих средств и сливным насосом

Lavabicchieri

cesto quadrato 50x50 cm

GLASSWASHER
LAVE-VERRES
GLÄSERSPÜLMASCHINE
LAVAVASOS
ПОСУДОМОЕЧНАЯ МАШИНА

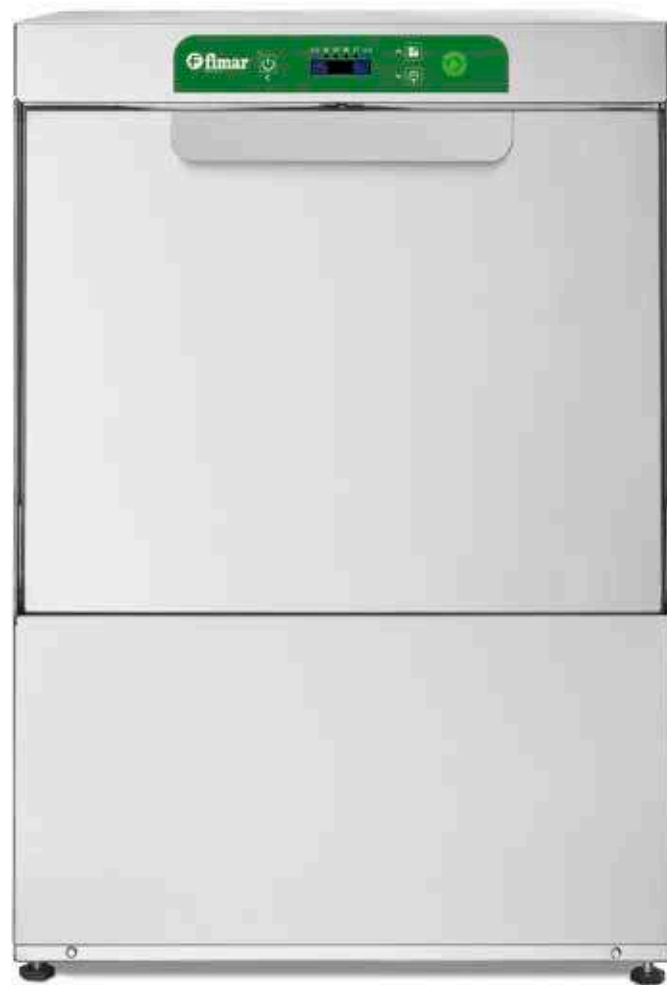

LAPI50N

LAPI50N LAPI50PLN

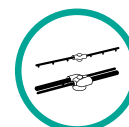

UP/DOWN



MAX H.340 MM



Ø MAX 365 MM - GN1/1



CARICO/SCARICO ACQUA
WATER INLET/DRAIN

OPTIONAL



422



415

IT Nuova versione di lavastoviglie con display led a 6 caratteri per la visualizzazione delle temperature di vasca e boiler - pulsante start multi-cromatico - 4 cicli di lavaggio - funzione risparmio energetico - sistema di autodiagnosi - ciclo di autopulizia a fine giornata. Struttura a doppia parete parziale in acciaio inox AISI 304, vasca stampata con angoli arrotondati, correntini guida cesto stampati - porta a doppia parete - bracci di lavaggio e risciacquo in materiale composito facilmente smontabili - microinterruttore su porta - altezza utile lavaggio 34 cm - possibilità di lavaggio teglie GN1/1 - riempimento automatico - risciacquo a caldo - funzione Thermostop - valvola antiriflusso di serie - dosatore elettrico del brillantante regolabile da display (LAPI50N) - dosatore elettrico del brillantante regolabile da display e pompa di scarico (LAPI50PLN).
In dotazione: 1 cesto bicchieri 50x50 cm - 1 cesto piatti 50x50 cm (12/18 posti) - 1 cesto porta cucchiaini - 1 tubo di carico acqua (lunghezza 2 m) - 1 tubo di scarico (lunghezza 2,5 m).

















FR Nouvelle version du lave-vaisselle avec affichage LED à 6 caractères des températures de la cuve et de la chaudière - bouton de démarrage multichrome - 4 cycles de lavage - fonction d'économie d'énergie - système d'autodiagnostic - cycle d'autonettoyage à la fin de la journée. Structure partielle à double paroi en acier inox AISI 304, cuve moulée avec angles arrondis, porte à double paroi - bras de lavage et de rinçage en matériau composite facilement amovibles - micro-interrupteur sur la porte - hauteur de lavage 34 cm - possibilité de laver les plateaux GN1/1 - remplissage automatique - rinçage à chaud - fonction Thermostop - soupape anti-reflux de série - distributeur de produit de rinçage électrique réglable par l'afficheur (LAPI50N) - distributeur de détergent et pompe de vidange (LAPI50PLN).
Livré avec: 1 panier à verre 50x50 cm - 1 panier à vaisselle 50x50 cm (12/18 places) - 1 panier à cuillères - 1 tuyau d'arrivée d'eau (longueur 2 m) - 1 tuyau de vidange (longueur 2,5 m).

ES Nueva versión de lavavajillas con pantalla LED de 6 caracteres para las temperaturas de la cuba y de la caldera - botón de inicio multicromo - 4 ciclos de lavado - función de ahorro de energía - sistema de autodiagnóstico - ciclo de autolimpieza al final del día. Estructura parcial de acero inoxidable AISI 304 de doble pared, cuba moldeada con esquinas redondeadas, guías de cestas moldeadas - puerta de doble pared - brazos de lavado y aclarado de material compuesto fácilmente extraíbles - microinterruptor en la puerta - altura de lavado 34 cm - posibilidad de lavar bandejas GN1/1 - llenado automático - aclarado en caliente - función Thermostop - válvula antirreflujo de serie - dosificador de abrillantador eléctrico regulable desde la pantalla (LAPI50N) - dosificador de detergente eléctrico y bomba de desagüe (LAPI50PLN).
Incluye: 1 cesto para vasos de 50x50 cm - 1 cesto para vajilla de 50x50 cm (12/18 plazas) - 1 cesto para cucharas - 1 tubo de entrada de agua (longitud 2 m) - 1 tubo de desagüe (longitud 2,5 m).

EN New version of dishwasher with 6-character LED display for tank and boiler temperatures - multi-chrome start button - 4 wash cycles - energy-saving function - self-diagnosis system - end-of-day self-cleaning cycle. Partial double-walled stainless steel AISI 304 structure, moulded tank with rounded corners, moulded basket guide rails - double-walled door - easily removable washing and rinsing arms in composite material - microswitch on door - washing height 34 cm - possibility of washing GN1/1 trays - automatic filling - hot rinsing - Thermostop function - standard anti-reflux valve - electric rinse aid dispenser adjustable from display (LAPI50N) - electric detergent dispenser and drain pump (LAPI50PLN).
Supplied with: 1 glass basket 50x50 cm - 1 dish basket 50x50 cm (12/18 places) - 1 teaspoon basket - 1 water inlet hose (length 2 m) - 1 drain hose (length 2.5 m).

DE Neue Version der Geschirrspülmaschine mit 6-stelligem LED-Display zur Anzeige der Tank- und Kesseltemperaturen - mehrfarbige Starttaste - 4 Spülgänge - Energiesparfunktion - Selbstdiagnosesystem - Selbstreinigungszyklus am Ende des Tages. Doppelwandige Teilstruktur aus Edelstahl AISI 304, geformter Tank mit abgerundeten Ecken, geformte Korbführungsschienen - doppelwandige Tür - leicht abnehmbare Wasch- und Spülarms aus Verbundwerkstoff - Mikroschalter an der Tür - Nutzhöhe 34 cm - ermöglicht das Waschen von GN1/1 - automatische Befüllung - Heißspülung - Thermostop-Funktion - serienmäßiges Rückflussverhinderungsventil - der über das Display (LAPI50N) - elektrischer Waschmittelpender und Ablaufpumpe (LAPI50PLN).
Mitgeliefert werden: 1 Gläserkorb 50x50 cm - 1 Geschirrkorb 50x50 cm (12/18 Plätze) - 1 Löffelkorb - 1 Wasserzulaufschlauch (Länge 2 m) - 1 Ablaufschlauch (Länge 2,5 m).

RU Новая версия посудомоечной машины с 6-символьным светодиодным дисплеем температуры бака и бойлера - многоцветная кнопка пуска - 4 цикла мойки - функция энергосбережения - система самодиагностики - цикл самоочистки в конце дня. Частичная конструкция из нержавеющей стали AISI 304 с двойными стенками, формованная ванна с закругленными углами, литые направляющие для корзин - дверь с двойными стенками - легко снимаемые рычаги мойки и ополаскивания из композитного материала - микровыключатель на двери - высота мойки 34 см - возможность мойки подносов GN1/1 - автоматическое наполнение - горячее ополаскивание - функция термостопа - стандартный антирефлюксный клапан - дозатор ополаскивателя (LAPI50N) - Дополнительно оснащена электрическим дозатором моющих средств и сливным насосом, регулируемый от дисплея и сливного насоса (LAPI50PLN).
В комплекте: 1 корзина для стаканов 50x50 см - 1 корзина для посуды 50x50 см (12/18 мест) - 1 корзина для ложек - 1 шланг для подачи воды (длина 2 м) - 1 сливной шланг (длина 2,5 м).

	LAPI50N	LAPI50PLN
	3,03 kW (1 PH) - 4,83 kW (3 PH)	
	230V/1N/50Hz	
	400V/3N/50Hz	
	0,35 kW	
	90° - 120° - 180° - 9' ciclo / cycle 40 - 30 - 20 - 7 cesti all'ora / baskets for hour	
	20 L	
	2 L	
	2,7 kW (1 PH) - 4,5 kW (3 PH)	
	5 L	
	2,4 kW	
	572 x 633 x 814(h) mm	
		
	50,5 Kg	
	58 Kg	
	660 x 720 x 960(h) mm	
	0,46 m ³	

OPTIONAL



* Con dosatore di detersivo elettrico e pompa di scarico
With electric detergent dispenser and drain pump
Дополнительно оснащена электрическим дозатором
моющих средств и сливным насосом

LAPI50CN
LAPI50CPLN

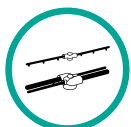

UP/DOWN



MAX H.425 MM



Ø MAX 365 MM - GN1/1



CARICO/SCARICO ACQUA
WATER INLET/DRAIN



LAPI50CN

Lavastoviglie
cesto quadrato 50x50 cm

DISHWASHER
LAVE-VAISSELLES
SPÜLMASCHINE
LAVAVAJILLA
ПОСУДОМОЕЧНАЯ МАШИНА

IT Nuova versione di lavastoviglie con cappotta con display led a 6 caratteri per la visualizzazione delle temperature di vasca e boiler - pulsante start multi-cromatico - 4 cicli di lavaggio - funzione risparmio energetico - sistema di autodiagnosi - ciclo di autopulizia a fine giornata. Struttura a singola parete in acciaio inox AISI 304, vasca con angoli arrotondati - sistema di sollevamento cappotta a molle - bracci di lavaggio/risciacquo inferiore e superiori in materiale composito facilmente smontabili - microinterruttore su cappotta - altezza utile lavaggio 42,5 cm - possibilità di lavaggio teglie GN1/1 - possibilità di start/stop automatico del ciclo di lavaggio con chiusura/apertura della cappotta - riempimento automatico - risciacquo a caldo - funzione Thermostop - valvola antiriflusso di serie - filtro di superficie in acciaio inox - dosatore elettrico del brillantante regolabile da display (LAPI50CN) - con dosatore di detersivo elettrico e pompa di scarico (LAPI50CPLN).
In dotazione: 1 cesto bicchieri 50x50 cm - 1 cesto piatti 50x50 cm (12/18 posti) - 1 cesto porta cucchiaini - 1 tubo di carico acqua (lunghezza 2 m) - 1 tubo di scarico (lunghezza 2,5 m).

















FR Nouvelle version du lave-vaisselle à capot avec affichage LED à 6 caractères pour la température de la cuve et de la chaudière - bouton de démarrage multichrome - 4 cycles de lavage - fonction d'économie d'énergie - système d'autodiagnostic - cycle d'autonettoyage en fin de journée. Structure à simple paroi en acier inox AISI 304, cuve avec angles arrondis - système de levage du capot à ressort - bras inférieurs et supérieurs de lavage/rinçage en matériau composite facilement amovibles - micro-interrupteur sur le capot - hauteur de lavage 42,5 cm - possibilité de laver des plateaux GN1/1 - possibilité de démarrage/arrêt automatique du cycle de lavage avec fermeture/ouverture du capot - remplissage automatique - rinçage à chaud - fonction Thermostop - vanne anti-reflux de série - filtre de surface en acier inox - distributeur de produit de rinçage électrique réglable par l'afficheur (LAPI50CN) - distributeur de détergent et pompe de vidange (LAPI50CPLN).
Livré avec: 1 panier à verre 50x50 cm - 1 panier à vaisselle 50x50 cm (12/18 places) - 1 panier à cuillères - 1 tuyau d'arrivée d'eau (longueur 2 m) - 1 tuyau de vidange (longueur 2,5 m).

ES Nueva versión de lavavajillas con capota con pantalla LED de 6 caracteres para las temperaturas de la cuba y de la caldera - botón de inicio multicromo - 4 ciclos de lavado - función de ahorro de energía - sistema de autodiagnóstico - ciclo de autolimpieza al final del día. Estructura monopared de acero inoxidable AISI 304, cuba con ángulos redondeados - sistema de elevación del capó mediante resorte - brazos de lavado/aclarado inferior y superior de material compuesto fácilmente extraíbles - microinterruptor en el capó - altura de lavado 42,5 cm - posibilidad de lavado de bandejas GN1/1 - posibilidad de inicio/parada automática del ciclo de lavado con cierre/apertura de la campana - llenado automático - aclarado en caliente - función Thermostop - válvula antirreflujo de serie - filtro de superficie de acero inoxidable - dosificador de abrillantador eléctrico regulable desde la pantalla (LAPI50CN) - dosificador de detergente eléctrico y bomba de desagüe (LAPI50CPLN).
Incluye: 1 cesto para vasos de 50x50 cm - 1 cesto para vajilla de 50x50 cm (12/18 plazas) - 1 cesto para cucharas - 1 manguera de entrada de agua (longitud 2 m) - 1 manguera de desagüe (longitud 2,5 m).

EN New version of hood dishwasher with 6-character LED display for tank and boiler temperatures - multi-chrome start button - 4 wash cycles - energy saving function - self-diagnosis system - self-cleaning cycle at end of day. Single-wall structure in stainless steel AISI 304, tank with rounded corners - spring-loaded hood lifting system - lower and upper washing/rinsing arms in composite material easily removable - microswitch on hood - washing height 42,5 cm - possibility of washing GN1/1 trays - possibility of automatic start/stop of the washing cycle by closing/opening the hood - automatic filling - hot rinse - Thermostop function - standard anti-reflux valve - stainless steel surface filter - electric rinse aid dispenser adjustable from display (LAPI50CN) - electric detergent dispenser and drain pump (LAPI50CPLN).
Supplied with: 1 glass basket 50x50 cm - 1 dish basket 50x50 cm (12/18 places) - 1 spoon basket - 1 water inlet hose (length 2 m) - 1 drain hose (length 2.5 m).

DE Neue Version der Geschirrspülmaschine mit Haube mit 6-stelligem LED-Display zur Anzeige der Tank- und Kesseltemperatur - mehrfarbige Starttaste - 4 Spülgänge - Energiesparfunktion - Selbstdiagnosesystem - Selbstreinigungszyklus am Ende des Tages. Einwandige Struktur aus Edelstahl AISI 304, Tank mit abgerundeten Ecken - federbelastetes System zum Anheben der Haube - unterer und oberer Wasch-/Spülarm aus Verbundwerkstoff leicht abnehmbar - Mikroschalter auf der Haube - Waschhöhe 42,5 cm - ermöglicht das Waschen von GN1/1 - automatischer Start/Stop des Waschzyklus durch Schließen/Öffnen der Haube - automatische Befüllung - Heißspülung - Thermostop-Funktion - serienmäßiges Rückflussverhinderungsventil - Oberflächenfilter aus Edelstahl - der über das Display (LAPI50CN) - elektrischer Waschmittelspender und Ablaufpumpe (LAPI50CPLN).
Mitgeliefert werden: 1 Gläserkorb 50x50 cm - 1 Geschirrkorb 50x50 cm (12/18 Plätze) - 1 Löffelkorb - 1 Wasserzulaufschlauch (Länge 2 m) - 1 Abflaufschlauch (Länge 2,5 m).

RU Новая версия посудомоечной машины с вытяжкой с 6-символьным светодиодным дисплеем температуры бака и бойлера - многоцветная кнопка пуска - 4 цикла мойки - функция энергосбережения - система самодиагностики - цикл самоочистки в конце дня. Одностенная конструкция из нержавеющей стали AISI 304, бак с закругленными углами - пружинная система подъема кожуха - нижние и верхние рычаги мойки/ополаскивания из композитного материала легко снимаются - микровыключатель на кожухе - высота мойки 42,5 см - возможность мытья подносов GN1/1 - возможность автоматического запуска/остановки цикла мойки путем закрытия/открытия вытяжки - автоматическое наполнение - горячее полоскание - функция термостопа - стандартный антирефлюксный клапан - поверхностный фильтр из нержавеющей стали - дозатор ополаскивателя (LAPI50CN) - Дополнительно оснащена электрическим дозатором моющих средств и сливным насосом, регулируемый от дисплея и сливного насоса (LAPI50CPLN).
В комплекте: 1 корзина для стаканов 50x50 см - 1 корзина для посуды 50x50 см (12/18 мест) - 1 корзина для ложек - 1 шланг для подачи воды (длина 2 м) - 1 сливной шланг (длина 2,5 м).

	LAPI50CN	LAPI50CPLN
	8,95 kW	
	400V/3N/50Hz	
	550 W	
	60" - 120" - 180" - 9' ciclo / cycle 60 - 30 - 20 - 7 cesti all'ora / baskets for hour	
	20 L	
	2 L	
	6 kW	
	5 L	
	2,4 kW	
	703 x 757 x 1494(h) mm	
		
	81,5 Kg	
	95 Kg	
	730 x 880 x 1690(h) mm	
	1,09 m³	

* Con dosatore di detersivo elettrico e pompa di scarico
 With electric detergent dispenser and drain pump
 Дополнительно оснащена электрическим дозатором
 моющих средств и сливным насосом

IN AND OUTLET TABLES
 TABLE D'ENTRÉE ET SORTIE
 EIN UND AUSLAUFTISCHE
 MESAS DE ENTRADA Y SALIDA
 ТАБЛИЦЫ ВХОДОВ И ВЫХОДОВ

Optional

ACCESSORIES
 ACCESSOIRES
 ZUBEHÖR
 ACCESORIOS
 АКЦЕССУАРЫ

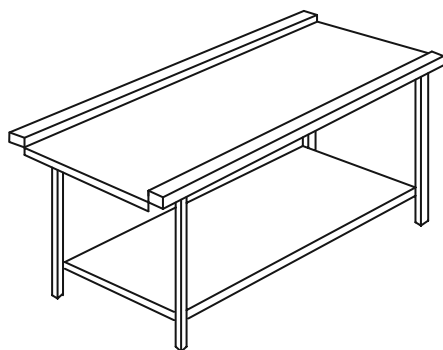

ACTAVOUT100

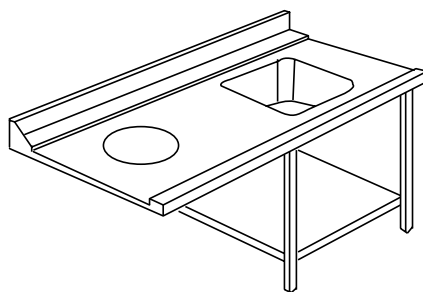

ACTAVINCV

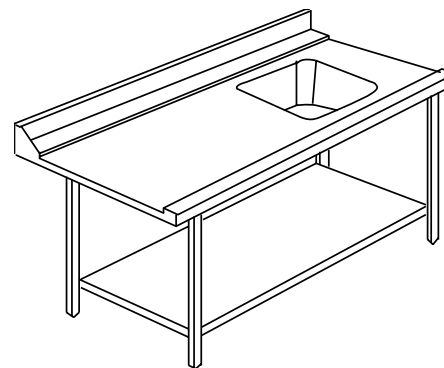

ACTAVINV

	ACTAVOUT100 (DX O SX)	ACTAVOUT120 (DX O SX)	ACTAVINCV (DX O SX)	ACTAVINV (DX O SX)
	Tavolo uscita senza alzatina Outlet table without backsplash Table de sortie sans dossieret Auslauftisch ohne aufkantung		Tavolo entrata cernita con vasca con alzatina Inlet table with bowl waste hole and backsplash Table d'entrée avec cuve trou de vidange et dossieret Zulauftisch mit becken abfallöffnung und aufkantung	Tavolo entrata con vasca con alzatina Inlet table with bowl with backsplash Table d'entrée avec bac et dossieret Einlauftisch mit becken und aufkantung
Mod.	LAPI50CN - LAPI50PLN			
 mm	1010 x 640 x 850/900(h) mm	1210 x 640 x 850/900(h) mm	1210 x 780 x 850/900(h) mm	
 Kg	36 Kg	42 Kg	41 Kg	
 Kg	40 Kg	46,5 Kg	45 Kg	
 mm	1100 x 700 x 1100(h) mm	1300 x 700 x 1100(h) mm	1300 x 800 x 1100(h) mm	
 m³	0,70 m³	0,84 m³	1,06 m³	



Al momento dell'ordine specificare se aggancio a sinistra o a destra per entrambi i tavoli
 Please specify when ordering if left or right fastening for both tables
 Lors de la commande, veuillez préciser pour les deux tables si l'accrochage doit se faire à gauche ou à droite
 Al hacer el pedido, indique para ambas mesas si se requiere la fijación a la izquierda o a la derecha
 Bitte geben sie bei der bestellung für beide tische an, ob die befestigung links oder rechts sein soll
 при заказе, пожалуйста, укажите для обоих столов, требуется ли левое или правое крепление

Optional

ACCESSORIES
ACCESSOIRES
ZUBEHÖR
ACCESORIOS
AKCECCYAPЫ



ACLAVCTSUP35





ACLAVCTSUP40



BV

	ACLAVCQ35	ACLAVCQ40	BV	ACLAVCT35	ACLAVCT40	ACLAVCTSUP35	ACLAVCTSUP40
	Cesto quadrato Square basket			Cesto tondo Round basket		Supporto per cesto tondo Round basket holder	
	350 x 350 x 150(h) mm	400 x 400 x 130(h) mm	500 x 500 x 106(h) mm	Ø 350 x 160(h) mm	Ø 400 x 180(h) mm	350 x 350 mm	400 x 400 mm

	RIA9	RIA16	RIA25	RIA36	RIA49	RIAU	COPCEST
	Rialzo bicchieri con separatori compresi - Extender for glasses with spacers Prolonge pour verres avec séparateurs inclus - Gläser-Aufsatz mit trennwände					Rialzo universale adatto all'inserimento di separatori Universal extender possibility of insertion of dividers	Coperchio universale Universal cover
	Separatore / Compartment divider Séparateur compartiments / Trennwand Fächer						
	n. 9	n. 16	n. 25	n. 36	n. 49		
	max Ø 150 mm	max Ø 110 mm	max Ø 89 mm	max Ø 73 mm	max Ø 62 mm		
	500 x 500 x 50(h) mm					500 x 500 x 50(h) mm	500 x 500 x 25(h) mm

	ACLAVPPOS	CP8	BP	BA	BVM
	Inserto porta posate quadrato Square cutlery holder insert	Inserto porta posate 8 scomparti 8 compartment cutlery holder insert	Base piatti - 18 piani - 12 fondi Dishes rack 18 Dinner plates - 12 soup plates	Base vassoi - 9 vassoi Trays rack - 9 trays	Base posate Cutlery rack
	113 x 113 x 89(h) mm	430 x 200 x 120(h) mm	500 x 500 x 106(h) mm		





ACLAVCQ35



ACLAVCQ40



ACLAVCT40



ACLAVCT35



ACLAVPPOS



CP8



BP



BVM



B9

	B9	B16	B25	B36	B49
	Base per bicchieri con separatori compresi - Glasses base with spacers Support pour verres avec séparateurs - Gläserkorb mit trennwände				
	Separatore / Compartment divider / Séparateur compartiments / Trennwand Fächer				
	n. 9	n. 16	n. 25	n. 36	n. 49
	max Ø 150 mm	max Ø 110 mm	max Ø 89 mm	max Ø 73 mm	max Ø 62 mm

NOT FOR SALE IN EXCE COUNTRY

	ACLAVDETS	ACLAVDETH	ACLAVBRILLS	ACLAVBRILLH
	Detergente liquido igienizzante - Sanitising liquid - Détergent liquide Sanitisierendes flüssiges - Geschirrspülmittel - Detergente líquido higienizante		Brillantante-additivo risciacquo - Rinse additive rinse - Additif de rinçage Klarspülerzusatz / Klarspüler für Geschirrspüler - Aditivo de aclarado	
	<15°F Lavastoviglie adatte ad acque dolci Dishwasher detergent suitable for fresh water	>15°F Lavastoviglie adatte per acque medie e dure Dishwasher detergent suitable for medium to hard water	<15°F Lavastoviglie adatte ad acque dolci Dishwasher detergent suitable for fresh water	>15°F Lavastoviglie adatte per acque medie e dure Dishwasher detergent suitable for medium to hard water
	2x5 Kg Confezioni / Packs for sale		2x6 Kg Confezioni / Packs for sale	

OPTIONAL







Fimar S.p.a.

Via Del Tesoro, 301

47826 Villa Verucchio (Rimini) Italy

t. +39 0541 670736

info@fimargroup.it

FIMARGROUP.IT
FIMARSPA.IT
EASYLINEBYFIMAR.IT
FORCAR.IT
FORCOLD.IT